



---

**Policy Title:** Complete Streets Policy  
**Policy Number:** TP021  
**Report Number:** TT2014-0307  
**Approved by:** Council  
**Effective Date:** 2014 November 03  
**Business Unit:** Transportation Planning

---

## **BACKGROUND**

1. In 2009 September, Council approved the Calgary Transportation Plan (CTP). Section 3.7 of the CTP includes 22 guiding policies for Complete Streets design. The CTP did not provide the detailed criteria to design, nor the process to implement Complete Streets, and several of the new design elements did not align with the current Design Guidelines for Subdivision Servicing, Section II: ROADS used by both the development industry and The City of Calgary staff. The Plan It Calgary Implementation Program (2010 February 17), therefore identified “developing and adopting complete street guidelines/handbook” as a key CTP implementation deliverable.
2. Complete Streets Policy aligns with CTP visions and policies for sustainable growth including a more compact city transportation network layout that promotes walking, cycling and transit, and preserving open space, parks and other environmental amenities. In addition, the Complete Streets Policy aligns with previous Council directions for Land Use and Mobility, Council priorities, and CTP Transportation Goals.
3. The Complete Streets Guide is one of the Transportation Department’s action items approved by Council for the 2012-2014 BPBC3 Business Cycle.

## **PURPOSE**

4. The purpose of this policy is:
  - a. To improve safety and accessibility for all road users. It provides comprehensive guidelines to The City of Calgary staff and the development industry on how to incorporate Complete Streets concepts into the planning (including engagement), design and construction of new streets, and reconstruction of existing streets. These guidelines better accommodate

- pedestrians, cyclists, street trees, and low-impact development while striving to maintain existing right-of-way requirements; and
- b. To create liveable neighborhoods by encouraging people to travel by walking, cycling, and taking transit. It will enhance the safety and security of streets for all users, promote attractive streetscapes, provide transportation options, reduce the total amount of paved lanes, promote the economic well-being of both businesses and residents, and increase civic space.

## **DEFINITIONS**

- 5. In this policy:
  - a. **“Calgary Transportation Plan”** (CTP) means the Calgary Transportation Plan approved by Council in 2009 September. The CTP provides policy direction on multiple aspects of the City’s Transportation system;
  - b. **“Complete Streets”** means a new selection of multi-modal streets that incorporate walking, cycling and transit, incorporate elements of green infrastructure and function in the context of surrounding land uses;
  - c. **“Design Guidelines for Subdivision Servicing” (DGSS)** means the City of Calgary developed collection of engineering design standards and guidelines for subdivision development, site development and redevelopment;
  - d. **“imagineCALGARY”** means the Plan for Long Range Sustainability, that includes a long-range visions and goals that reflect the diversity of aspirations and interests of the community now and into the future;
  - e. **“Municipal Development Plan” (MDP)** means the City of Calgary Municipal Development Plan adopted by Council in 2009 September; and
  - f. **“Plan It Calgary”** means the Plan It Calgary Implementation Program approved by Council in 2010 February. Plan It Calgary was the process for developing and integrated MDP and CTP.

## **POLICY**

- 6. The Complete Streets Policy is detailed in the Complete Streets Guide, Schedule “A”.

## **PROCEDURE**

- 7. The following procedures guide the Complete Streets Policy:

- 7.1 **Design Standards for New Streets (Greenfield):** Right-of-way requirements and design concepts for new streets are provided in the Complete Street Guide. Detailed designs, such as cross-sections and intersection designs, surface and underground infrastructure designs, to facilitate new street construction, are provided in the latest DGSS (Section II: ROADS). All designs submitted to the City must conform to or exceed the design standards contained in the latest DGSS (Section II: ROADS).
- 7.2 **Alternative Design Standards for New Streets (Greenfield):**
- 7.2.1 A design not conforming to the latest DGSS, shall only be approved, at the discretion of the Director, Transportation Planning, where it is determined that:
- a) topographic or other natural constraints require a narrower right-of-way and/or revised elements; or
  - b) specific conditions for pedestrians, cyclists, and/or transit require an alternate arrangement of the elements within the standard right-of-way; or
  - c) an alternative standard is proposed that:
    - i. meets or exceeds the new standard;
    - ii. creates an equivalent or, preferably, improved streetscape appearance over the standards that it replaces;
    - iii. results in a cost efficient design in terms of construction, long term maintenance and replacement; and
    - iv. allows for low impact development in its design
- 7.2.2 A written rationale for the alternative design must be submitted in conjunction with or in advance of development application submission.
- 7.2.3 An approved alternative design can only be applied to a specific geographic area for a specific application.
- 7.3 **Design Standards for Retrofit Streets:**
- 7.3.1 In established areas, all efforts shall be made to conform to the right-of-way requirements contained in the Complete Streets Guide and the standards of the latest DGSS;

- 7.3.2 Where existing constraints (such as existing buildings, or rights-of-way) prevent right-of-way compliance, an alternative design standard may be approved at the discretion of the Director, Transportation Planning;
  - 7.3.3 Alternative designs must meet or exceed the minimum requirements for street elements as indicated in the Complete Streets Guide;
  - 7.3.4 A written rationale for the alternative design must be submitted at the time of development application submission; and
  - 7.3.5 An approved alternative design can only be applied to a specific geographic area for a specific development application.
- 7.4 **Implementation of the Complete Streets Policy and Complete Streets Guide:** The implementation of this policy and the Complete Streets Guide for all public road projects includes the following key actions:
- 7.4.1 Revision of the Transportation, Planning, Water Resources, and Urban Forestry standards, specifications, and processes so that there is alignment with this policy and the Complete Streets Guide;
  - 7.4.2 Regular three (3) year review and update, in consultation with the development industry, of the Complete Streets Guide and Complete Streets Policy;
  - 7.4.3 Education and promotion of the Complete Streets Guide to City of Calgary Business Units, the development industry, engineering consultant firms, and Calgary communities; and
  - 7.4.4 Monitoring of city-wide Complete Streets progress through data collection and reporting.

## **AMENDMENTS**

New Policy



# 2014

## Complete Streets Guide

### DOCUMENT PURPOSE

---

The Complete Streets Guide has been created to foster a better understanding of the Calgary Transportation Plan (CTP) and Municipal Development Plan (MDP). It provides guidance for the implementation of policies and concepts contained in these plans.

The Guide provides direction to City Administration and to the development industry on how to incorporate Complete Streets concepts (including enhanced public realm) into the planning, design, and reconstruction of existing streets and construction of new streets. Reconstruction (or retrofit) guidance is the primary focus of the Guide.

In conjunction with the development of this Guide, major revisions have been made to The City's current new Street Design Standards to accommodate pedestrians, cyclists, street trees, and low-impact development (e.g., source control practices for storm water) while maintaining existing right-of-way requirements. These new standards replace the 20-year-old existing standards contained in The City of Calgary Design Guide for Subdivision Servicing.

The latest electronic versions of both the Complete Streets Guide and the Design Guide for Subdivision Servicing can be found at the Complete Streets webpage: [www.calgary.ca/completestreets](http://www.calgary.ca/completestreets).

## LETTER FROM THE GENERAL MANAGER OF TRANSPORTATION

---

Dear Calgarians,

Nearly five years after Plan It Calgary and the Calgary Transportation Plan were adopted by Council, I'm proud to announce that the Transportation Department has completed a new document that brings the City one step closer to turning plans into practice – The City of Calgary Complete Streets Guide.

The Calgary Transportation Plan and, now, the Complete Streets Guide place a greater emphasis on the pedestrian environment, bicycle infrastructure, accessible design and street trees. The Guide will ensure that the development industry, utility companies, and City Administration all work from a single document when planning, designing, and reconstructing existing streets or constructing new streets.

The Guide is the result of three years of hard work by a collaborative team that crosses several business units and departments across the Administration. Through the process, new relationships have been forged and trust has been built. How this Guide was developed serves as a template for how complete street projects should be conducted – through engagement and collaboration from the project start with a goal of mutual success and a great city.

With the Guide now finished, we will now focus our attention on updating detailed standards, agreements and processes. This will ensure that all street projects, regardless of scope, are constructed to be safe, accessible, and attractive – or, to put it another way, made “complete.”

Sincerely,

Malcolm Logan  
General Manager, Transportation



# TABLE OF CONTENTS

## INTRODUCTION

<b>I.1</b>	<b>Calgary Transportation Plan</b> . . . . .	<b>1</b>
	I.1.1 CTP and MDP . . . . .	1
	I.1.2 CTP Network Maps . . . . .	1
	I.1.3 CTP Guiding Policies . . . . .	2
<b>I.2</b>	<b>Complete Streets</b> . . . . .	<b>2</b>
	I.2.1 Objectives . . . . .	2
	I.2.2 Principles of Road Right-of-Way Variance . . . . .	3
	I.2.3 Street Design Elements. . . . .	3

## CHAPTER 1

<b>New Street Classifications</b> . . . . .	<b>5</b>	
<b>1.1</b>	<b>Conventional Hierarchical Classification System</b> . . . . .	<b>5</b>
<b>1.2</b>	<b>Multi-Modal Classification System</b> . . . . .	<b>5</b>
<b>1.3</b>	<b>Calgary Transportation Plan Street “Families”</b> . . . . .	<b>6</b>
<b>1.4</b>	<b>Calgary Transportation Plan Street Classifications</b> . . . . .	<b>7</b>
<b>1.5</b>	<b>Differences Between Existing and CTP Street Types</b> . . . . .	<b>11</b>

## CHAPTER 2

<b>Network Design Guidelines</b> . . . . .	<b>13</b>	
<b>2.1</b>	<b>Benefits of Complete Street Network Design</b> . . . . .	<b>13</b>
<b>2.2</b>	<b>Designing Street Networks to Support Complete Streets Principles.</b> . . . . .	<b>14</b>
<b>2.3</b>	<b>Network Design Guidelines</b> . . . . .	<b>15</b>
<b>2.4</b>	<b>Connectivity Indices</b> . . . . .	<b>16</b>

## CHAPTER 3

<b>Street Design Guidelines</b> . . . . .	<b>17</b>	
<b>3.1</b>	<b>General</b> . . . . .	<b>17</b>
	3.1.1 Introduction . . . . .	17
	3.1.2 Street Design Principles . . . . .	17
	3.1.3 Geometric Design Standards . . . . .	22
<b>3.2</b>	<b>Pedestrian Design</b> . . . . .	<b>25</b>
	3.2.1 Pedestrian Policy (TP-010). . . . .	25
	3.2.2 Access Design Standards . . . . .	26
	3.2.3 Safety and the Walking Environment. . . . .	26
	3.2.4 Pedestrian Design Principles. . . . .	27
	3.2.5 Pedestrian Design Guidelines . . . . .	32
<b>3.3</b>	<b>Bikeway Design</b> . . . . .	<b>33</b>
	3.3.1 Bicycle Policy (TP-011) . . . . .	33
	3.3.2 Bikeway Design Principles . . . . .	34
	3.3.3 Bikeway Design Guidelines . . . . .	36
<b>3.4</b>	<b>Transit Design</b> . . . . .	<b>37</b>
	3.4.1 Introduction . . . . .	37
	3.4.2 Network Design . . . . .	38
	3.4.3 Transit Priority . . . . .	40
	3.4.4 Transit Stop Design . . . . .	41
	3.4.5 Conclusion . . . . .	44
	3.4.6 Checklist . . . . .	44
<b>3.5</b>	<b>Traffic Calming Design</b> . . . . .	<b>45</b>

**TABLE OF CONTENTS**

3.5.1 Purpose . . . . .	45
3.5.2 Traffic Calming Policy (TP-002). . . . .	46
<b>3.6 Streetscape Design . . . . .</b>	<b>51</b>
3.6.1 Green Infrastructure and Low Impact Development . . . . .	51
3.6.2 Urban Forestry. . . . .	58
3.6.3 Shallow Utility Design . . . . .	62
3.6.4 Public Realm Design. . . . .	63
<b>3.7 Intersection Design . . . . .</b>	<b>75</b>
3.7.1 General . . . . .	75
3.7.2 Intersection Corners . . . . .	77
3.7.3 Roundabouts . . . . .	80
3.7.4 Elements of a Good Intersection. . . . .	81
3.7.5 New Intersection Detailed Plans . . . . .	81
<b>3.8 Access Management. . . . .</b>	<b>83</b>
 <b>CHAPTER 4</b>	
<b>Retrofit Street Design Guidelines and Process . . . . .</b>	<b>87</b>
4.1 Context Sensitive Design . . . . .	87
4.2 Constrained Corridors . . . . .	92
4.3 Primary Corridors . . . . .	92
4.4 Complete Case Studies . . . . .	93
4.5 Future Case Studies . . . . .	98
 <b>CHAPTER 5</b>	
<b>New Street Design Standards . . . . .</b>	<b>103</b>
5.1 Minimum Standards . . . . .	103
5.2 Design Guide for Subdivision Servicing . . . . .	104
5.3 Revised Street Design Standards . . . . .	105
 <b>CHAPTER 6</b>	
<b>Costs and Funding . . . . .</b>	<b>119</b>
6.1 New Street Costs. . . . .	119
6.2 Retrofit Street Costs . . . . .	120
6.3 Funding Strategies . . . . .	120
6.3.1 Increase Municipal Funding to Mobility Corridor Projects and Programs . . . . .	120
6.3.2 Revised Project Design Process . . . . .	121
6.3.3 Establish Business Revitalization Zones . . . . .	121
6.3.4 Supporting Partnerships for Urban Reinvestment (SPUR) . . . . .	121

# TABLE OF CONTENTS

---

## CHAPTER 7

<b>Implementation Strategy</b>	.123
7.1 Standards and Specifications	.123
7.2 Bylaws and Policy	.124
7.3 Processes	.124
7.3.1 Policy Document Development	.124
7.3.2 Development Application Review	.124
7.3.3 Transportation Projects	.125
7.3.4 Maintenance Program	.126
7.4 Monitoring	.126
7.4.1 Indicators and Targets	.126
7.4.2 Complete Streets Scoring Tool	.127
7.5 Education	.127
7.6 Implementation Actions	.127

## APPENDICES

<b>Appendix A</b>	.129
Other Future Case Studies	.129
<b>Appendix B</b>	.135
CTP Maps	.135
<b>Appendix C</b>	.145
Complete Streets Scoring Tool	.145
<b>Appendix D</b>	.147
Related City Guidelines and Policies	.147
<b>Appendix E</b>	.155
Glossary of Terms	.155
<b>Appendix F</b>	.157
Other Publications	.157
<b>Appendix G</b>	.161
Continuing Research	.161
<b>Appendix H</b>	.163
References	.163
<b>Appendix I</b>	.165
Acknowledgments	.165



# Introduction

## I.1 CALGARY TRANSPORTATION PLAN

---

### I.1.1 CTP and MDP

In 2007, City Council directed that an integrated Municipal Development Plan (MDP) and Calgary Transportation Plan (CTP) be created to align with the vision and goals of imagineCALGARY, an extensive community visioning process to shape the city's future over the next 100 years. The integrated process, known as Plan It Calgary, set out the long-term direction for sustainable growth to accommodate another 1.3 million people in Calgary over the next 60 to 70 years.

Council approved the MDP and CTP in September 2009. The plans set out the vision and policies for sustainable growth including a more compact city layout that promotes walking, cycling and transit, and preserves open space, parks and other environmental amenities. The plans provide a comprehensive and integrated land use and transportation policy framework, design guidelines and operational procedures that support planning, development and corporate growth decisions.

### I.1.2 CTP Network Maps

The CTP provides a long-range vision for the transportation network of the city as a whole. This vision is expressed in a series of maps, which lay out the major features of the future street network, and identify a series of functional requirements for specific streets within that network. With the exception of the Primary Transit Network and the Downtown Transit Network, all seven of the CTP maps represent the vision of the street network in 60 years (~2070). The Transit Network is a 30-year vision (~2040). These maps are found at the back of the CTP and in **Appendix B** of this Guide.

Map 1: Primary Cycling Network

Map 2: Primary Transit Network

Map 3: Downtown Transit Network

Map 4: Conceptual Calgary Regional Transit Plan

Map 5: Primary Goods Movement Network

Map 6: Primary High Occupancy Vehicle Network

Map 7: Road and Street Network

One of the first steps of any transportation project should be to reference these maps to establish the function and context of the corridor. To better understand local contextual issues and other details not identified on these maps, functional studies and local area policy plans should be consulted for specific locations. Any project involving development or redevelopment within the city of Calgary should respond to the intended long-term function for the affected streets so that near-term development conforms to the vision of the CTP.

### I.1.3 CTP Guiding Policies

Section 3.7 of the CTP includes 22 guiding policies for Complete Streets. These policies can be categorized into eight areas:

- a) planning, design and maintenance of Complete Streets
- b) adaptability
- c) access
- d) green Infrastructure
- e) public realm
- f) utilities and line assignment
- g) river and creek crossings
- h) collaboration and public engagement

The principles behind the guidelines in this document originated from these policy areas.

## I.2 COMPLETE STREETS

### I.2.1 Objectives

Objective #7 of the CTP states:

*“Complete Streets aim to increase the attractiveness, convenience and safety of all modes of transportation by creating a new selection of multi-modal streets that emphasize walking, cycling and transit, incorporate elements of green infrastructure and function in the context of surrounding land uses.”*

A Complete Street is a street for which the needs of all users (all ages, income levels, and levels of physical ability) have been considered in its planning and design (or redesign). All users are not necessarily accommodated to the highest standards possible, particularly when right-of-way is limited. There is often the need for trade-offs between the users sharing the space in order to achieve the end design. The goals of Complete Streets philosophy should be the primary consideration when implementing these trade-offs.

A Complete Streets approach seeks to design a transportation network that will:

- serve the land uses adjacent to the street, integrating mobility as a means, not an end;
- encourage people to travel by walking, cycling, and transit;
- provide transportation options for people of all ages, physical abilities, and income levels;
- enhance the safety and security of streets, from both a traffic and personal perspective;
- improve people’s health;
- create liveable neighbourhoods;
- reduce the total amount of paved area;
- reduce streetwater runoff into watersheds;
- maximize infiltration and reuse of stormwater;
- reduce greenhouse gas emissions and other air pollutants;
- reduce energy consumption;
- promote the economic well-being of both businesses and residents;
- increase civic space and encourage social interaction;
- promote alternative streetscapes.

The Complete Streets Guide helps to achieve these goals by providing guidelines around pedestrian realm, street, and network design.



## I.2.2 Principles of Road Right-of-Way Variance

In 2010, Council approved the following Principles of Road Right-of-Way Variance for the protection and allocation of road right-of-way:

1. Provide additional right-of-way for Regional and Primary Transit.
2. Protect existing right-of-way for upgrading of new Complete Street types.
3. The allocation of right-of-way must consider the safety of all users first.
4. The allocation of right-of-way must consider transportation function and adjacent land use.
5. The allocation of right-of-way must consider the priorities of all transportation modes.
6. Corridor redevelopment should be staged and tied to land use redevelopment.
7. Consider narrow travel lane widths on all streets (except Skeletal Roads) in Transit Oriented Development (TOD) areas and Activity Centres/Corridors identified on Map 1, MDP.
8. Street design should promote slower automobile speeds, not increased automobile capacity on all streets (except Skeletal Roads) in TOD areas and Activity Centres/Corridors identified on Map 1, MDP.
9. Consider varying right-of-way when required to protect heritage resources.
10. Consider the protection of space for underground or aerial utilities.

These principles align with CTP and Transportation goals and inform the guidelines contained within this Guide.

## I.2.3 Street Design Elements

Complete Streets consist of horizontal and vertical environments.

The horizontal environment of a Complete Street consists of three zones:

**Roadway Zone:** provides travel and parking lanes for motorized vehicles and bicycles in a mixed traffic environment.

**Public Realm Zone:** includes green infrastructure, street furnishings, and travel lanes for pedestrians and, often, cyclists.

**Interface Zone:** includes pedestrian-oriented land use and design. As private ownership falls within this area, more space can be created through the use of building setback, bylaw setbacks, and/or public access easements.

The vertical environment of a Complete Street consists of three zones:

**Aerial Zone:** includes street lights, signal heads, tree canopy, etc.

**Surface Zone:** includes sidewalks, pathways, street furniture, curbs, bike racks.

**Buried Zone:** includes parkades, plant and tree trenches, deep and shallow utilities.

These environments and zones are illustrated in Figure I-1.

Figure I-1: Complete Street zones

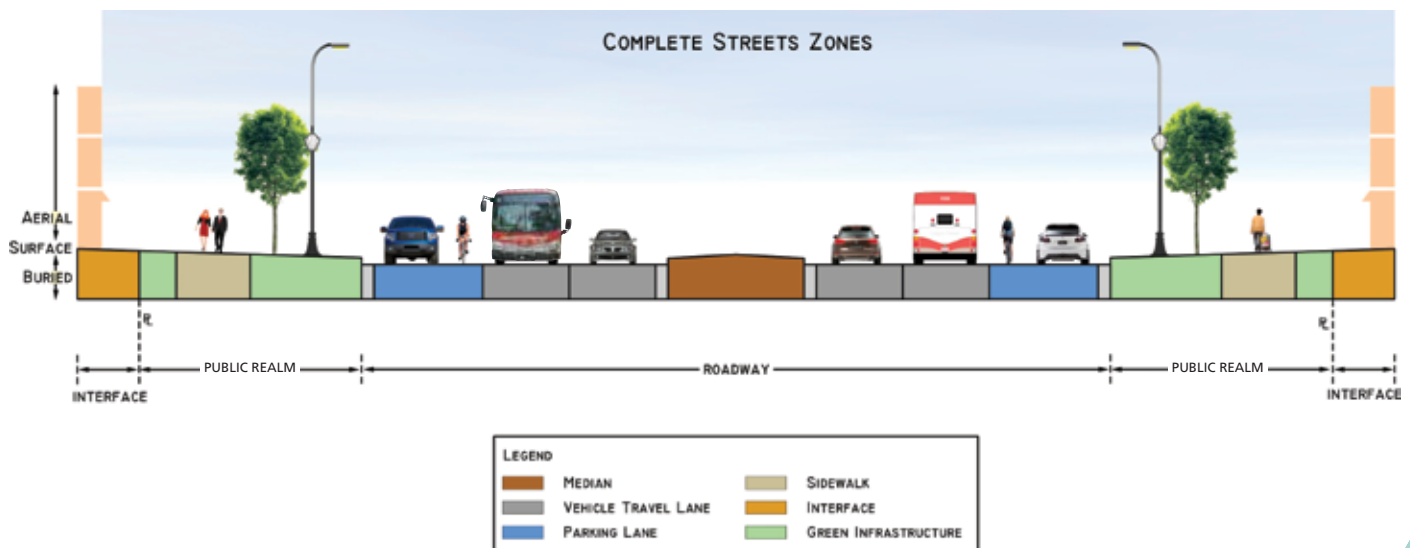

Green infrastructure and public realm elements are present in both horizontal and vertical zones. Tree plantings, for example, may be a component of all zones, but also contribute to the public realm. Complete Street elements for each zone should be selected based on the function of the street classification, adjacent land use context, and the priorities set out in the Revised Road and Street Palette (Table 1.4-14). The elements of each horizontal and vertical zone are summarized in Table I-2.

The zone elements in Table I-2 are interrelated. Some elements need exclusive space (e.g., travel lanes on the surface of the roadway), while other elements could share

space in designated zones (e.g., shallow utilities). Not all elements of the roadway or public realm zones will be used in the design of a Complete Street, especially in a retrofit situation. Sidewalks, for example, would not be used in the design of a Skeletal Road, whose primary function is moving vehicles, goods and services at high speeds however, pathways should be considered adjacent to skeletal Roads.

The cross-sections contained in this Guide illustrate the need to balance the competing requirements for space within a given right-of-way, while being sensitive to the context and priority of the different street types.

Table I-2: Complete Street zone elements

HORIZONTAL ZONE								
		INTERFACE	PUBLIC REALM			ROADWAY		
		Frontage	Throughway	Furnishing	Edge	Auxiliary lanes	Travel lanes	Median
VERTICAL ZONE	<b>Aerial</b>	Building overhang Tree canopy	Tree canopy	Tree canopy	Lighting Tree canopy	Lighting Tree canopy Signal heads Signs	Signs Signal heads	Lighting Signal heads Signs
	<b>Surface</b>	Patios Awnings Entries Plantings	Sidewalk Urban Braille Multi-use pathways	Lights Utility poles Transformers Pedestals Hydrants Transit shelters Receptacles Bike racks Benches Trees Plantings	Curbs Meters Signs Shoulders Bollards Snow storage Drainage Catch basins	Transit lane Shared lane Turn lanes Bike lane Parking Loading zones Curb extensions Pavement markings Drainage	Through lanes	Raised plantings Flush Depressed Turning lane Snow storage Drainage
	<b>Buried</b>	Shallow utilities Plant trenches Parkades	Shallow utilities	Tree trenches Shallow utilities Vaults	Shallow utilities	Shallow utilities	Deep utilities Manholes	Tree trenches Shallow utilities

# 1

## Chapter 1 New Street Classifications

### 1.1 CONVENTIONAL HIERARCHICAL CLASSIFICATION SYSTEM

Prior to the introduction of the Complete Streets Guide, the Calgary transportation network, as with cities throughout North America, was developed using a conventional hierarchical classification system based primarily on private vehicle function. This approach was reflected in the design standards of all classifications of streets found in the existing Design Guide for Subdivision Servicing – the latest version of street standards applied to new developments.

Figure 1.1-1: Relationship of functionally classified systems in serving traffic mobility and land access (FWHA, Figure II-4)

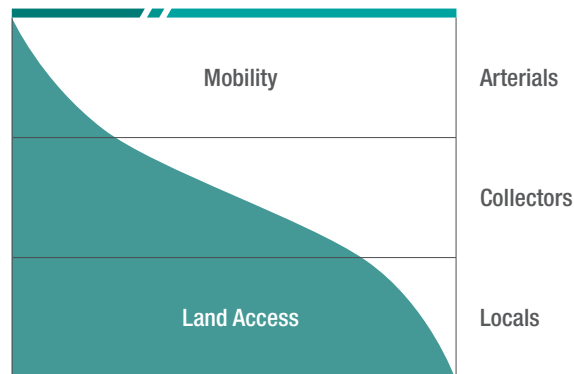

### 1.2 MULTI-MODAL CLASSIFICATION SYSTEM

The CTP and MDP call for an updated approach to street design that embraces Complete Streets philosophy and provides designers with guidance on how to design Complete Streets.

This updated approach, while still hierarchical, is informed by all modes of transportation, with a greater focus on the pedestrian, cyclist, and transit user.

Historically, streets were designed by following a conventional classification system to determine a specific geometric design. The Complete Streets approach is based more on designing for the local context of the street, and the need to balance a safe environment for pedestrians and cyclists with convenience for vehicle traffic.

### 1.3 CALGARY TRANSPORTATION PLAN STREET “FAMILIES”

---

Building upon the CTP, the entire palette of street types are contained within four “families” of streets.

#### **SKELETAL**

These roadways primarily provide movement between one area of the city and another. They are typically higher-speed roadways, used for private vehicles and goods movement with limited support allowances for active modes of travel.

#### **ARTERIAL**

These streets serve to connect the majority of city streets to the Skeletal Road network. In this Guide, these streets have been redesigned to better accommodate all users within the existing right-of-way standards. Their function is to provide a transition from the movement of Skeletal Roads to local streets.

#### **LIVEABLE**

These new streets, introduced by the CTP, serve to provide higher-capacity streets within communities and development areas where active modes and local commercial activity will take precedence over private vehicle and goods movement activity. A liveable street is a street with emphasis on modes of travel that enable social interaction (e.g., walking, cycling, transit). It is a destination as well as a route for travel. The vision of the CTP and MDP is that liveable streets will become significantly more common in future development and redevelopment (or revitalization) projects.

#### **LOCAL**

These streets are smaller scale streets that serve primarily residential areas, but also industrial subdivisions and activity centres. Designs are focused on serving local users only. These streets represent the highest proportion of streets city-wide, and emphasis on integrating green infrastructure (e.g., street trees) is a priority.

## 1.4 CALGARY TRANSPORTATION PLAN STREET CLASSIFICATIONS

As a result of Complete Streets philosophy, two streets of the same classification (Arterial, for example) may have differences in the number of lanes, boulevard width, and intersection treatments due to the contextual differences and location of the streets.

From these four “families” of streets come 13 specific street classifications summarized as follows:

### 1) SKELETAL ROAD (FAMILY: SKELETAL – FIGURE 1.4-1)

Formerly known as expressways and freeways, these roads promote the movement of vehicular traffic over long distances and typically carry a minimum of 30,000 vehicles per day (vpd). They operate at high speeds (80-100 km/h), have limited direct access, and therefore limited interaction with adjacent land uses. The interchange spacing on Skeletal Road is 2.0 – 2.4 km. Facilities within the Skeletal Road right-of-way for walking and cycling are not common, but sometimes vital to regional pathway connectivity.

### 2) ARTERIAL STREET (FAMILY: ARTERIAL – FIGURE 1.4-2)

Formerly known as Major Streets, Arterial Streets provide a reasonably direct connection between multiple communities and major destinations. They typically carry between 20,000 and 35,000 vpd (for four-lane, higher for six-lane) and are spaced 800 metres apart for interim conditions only (for intersection spacing on Skeletal Roads). Arterial Streets make up much of the Primary Transit Network. Green infrastructure strategies may include vegetated swales, rain gardens, filter strips, and native vegetation.

### 3) INDUSTRIAL ARTERIAL STREET (FAMILY: ARTERIAL – FIGURE 1.4-3)

These streets place highest priority on the efficient movement of heavy trucks, but still accommodate all modes of travel. They are typically lower-speed streets with a high percentage of truck volume, often as high as 30 per cent. Industrial Arterials typically carry between 10,000 and 30,000 vpd. The size of the adjacent industrial lots dictates the level of connectivity or access.

### 4) LOCAL ARTERIAL STREET (FAMILY: ARTERIAL – FIGURE 1.4-4)

Formerly known as Local Majors, Local Arterial Streets provide connections between communities and destinations where traffic volumes are at the low end of the range for Arterials (typically 15,000 to 20,000 vpd). Minimum intersection spacing of 150 m if no left turn bays are required. Wherever possible, a greater spacing should be used.

Figure 1.4-1: Crowchild Trail N.W.



Figure 1.4-2: 2012 Northland Drive N.W. adjacent to Northland Village Centre



Figure 1.4-3: 106th Avenue S.E. adjacent to Southbend Business Park



Figure 1.4-4: 85th Street S.W. in the community of West Springs





**5. URBAN BOULEVARD (FAMILY: LIVEABLE – FIGURE 1.4-5)**

Urban Boulevards form the backbone of higher density corridors and activity centres. While high volumes of vehicular activity are still expected, walking, cycling, and transit are given higher priority. These streets are local and regional destinations, fully integrated with adjacent mixed land uses, and provide high levels of connectivity to surrounding communities. They typically carry between 17,500 and 25,000 vpd. High-quality urban design and green infrastructure are critical components of Urban Boulevards. Urban Boulevards also make up some of the Primary Transit Network. A level of congestion appropriate for a dense urban area is acceptable for this street type.

**6. PARKWAY (FAMILY: LIVEABLE – FIGURE 1.4-6)**

Parkways focus on the integration with natural areas. Adjacent land uses include large natural parks, waterways, or special public institutions (e.g., campuses). Natural vegetation and new forms of stormwater management are integrated with the street. Parkways present opportunities to maximize water infiltration; slow and detain rainfall; enhance the urban forest; and preserve and enhance biodiversity. Walking and cycling modes are given higher priority. They typically carry between 20,000 and 35,000 vpd.

**7. NEIGHBOURHOOD BOULEVARD (FAMILY: LIVEABLE – FIGURE 1.4-7)**

Neighbourhood Boulevards are similar to Urban Boulevards, but on a smaller scale, with walking and cycling given a higher priority. These streets are destinations for the local communities surrounding them, and provide the highest level of connectivity within this family of streets. Though not a requirement, these streets support mixed-use retail and medium-density residential uses. As with Urban Boulevards, high-quality urban design and green infrastructure are important components. They typically carry between 12,500 and 22,500 vpd.

**8. PRIMARY COLLECTOR STREET (FAMILY: LOCAL – FIGURE 1.4-8)**

Primary Collector Streets connect lower-volume local streets to Arterial Streets, and generally serve transit. Typical daily traffic volume range from 8,000 to 15,000 vpd. Primary Collector Streets may be divided or undivided, include or restrict parking, and have two or four travel lanes.

**9. ACTIVITY CENTRE STREET (FAMILY: LOCAL – FIGURE 1.4-9)**

This is a new street classification designed to provide a locally scaled street appropriate for activity nodes. As with Neighbourhood Boulevards, walking and cycling have high priority. Typical daily traffic volumes range from 3,000 to 15,000 vpd. These are streets that support major activity centres (including Transit Oriented Development) in addition to commercial and residential land uses. These streets typically have parking on both sides with two travel lanes, and low travel speeds. Street furniture, trees and other forms of green infrastructure are important elements. Adjacent land uses are medium- to high-density mixed-use.

Figure 1.4-5: 49th Street N.W. adjacent to Market Mall



Figure 1.4-6: University Drive N.W. adjacent to Foothills Athletic Park



Figure 1.4-7: Garrison Gate S.W. in the community of Garrison Woods



Figure 1.4-8: Charleswood Drive N.W.



Figure 1.4-9: Kensington Road N.W.



**10. COLLECTOR STREET (FAMILY: LOCAL – FIGURE 1.4-10)**

Collector Streets collect traffic from Arterial Streets and Primary Collectors and distribute it to other local streets. Typical daily traffic volume range from 2,000 to 8,000 vpd. Transit and direct access to adjacent properties is permitted.

**11. INDUSTRIAL STREET (FAMILY: LOCAL – FIGURE 1.4-11)**

Industrial Streets provide direct access to adjacent industrial and commercial properties. They are lower-speed two-lane streets designed with enough width to accommodate frequent heavy vehicles. Though all modes are accommodated, movement of goods has the highest priority. Typical daily traffic volume range from 3,000 to 12,000. As industrial areas are served by transit to support employees, sidewalks are required on both sides of the street.

**12. RESIDENTIAL STREET (FAMILY: LOCAL – FIGURE 1.4-12)**

Residential Streets provide direct access to adjoining low- and medium-density residential properties. Direct access is not permitted to commercial properties because high amounts of traffic are not suitable for residential areas. Residential Streets are low-speed, low-volume typically < 2,000 vpd two-lane streets, typically designed to provide on-street parking on both sides. Green infrastructure should be incorporated, though may be limited due to the narrow right-of-way on these streets.

**13. LANE (ALLEY) (FAMILY: LOCAL – FIGURE 1.4-13)**

The primary function of Lanes is to provide direct rear access to adjoining low- to high-density residential properties. They also serve as access for recycling/waste collection, deliveries, loading/unloading, and may serve as an alternate alignment for shallow, deep or overhead utilities.

Figure 1.4-10: Collector Street



Figure 1.4-11: 48th Street in the Eastlake industrial area



Figure 1.4-12: Residential Street



Figure 1.4-13: Lane (Alley)



Although individual street designs are dependent on the particular context in which they are designed, all streets in any one classification share a common purpose within the transportation network. That common purpose is best articulated in Table 1.4-14: Road and Street Palette, where different priorities, or levels of accommodation, are assigned to that particular street classification.

Table 1.4-14: Road and street palette

		TRANSPORTATION MODES						
CTP CLASSIFICATION		Walking	Cycling	Transit	Goods	Autos*	EXAMPLES	
Skeletal	Skeletal Road	[Red]		[Yellow]		[Green]	Glenmore Tr. S.W.	
Arterial	Arterial Street	[Yellow]		[Green]				Northland Dr. N.W.
	Industrial Arterial	[Yellow]			[Green]	[Yellow]	114th Ave. S.E.	
	Local Arterial	[Green]	[Yellow]	[Green]	[Yellow]	[Green]	[Yellow]	85th St. S.W.
Liveable	Urban Boulevard	[Green]			[Green]	[Yellow]	49th St. N.W.	
	Parkway	[Green]		[Yellow]	[Red]	[Yellow]	University Dr. N.W.	
	Neighborhood Boulevard	[Green]		[Yellow]	[Red]		Garrison Gt. S.W.	
Local	Primary Collector	[Green]			[Yellow]	[Red]	Fifth Ave. N.W.	
	Activity Center Street	[Green]			[Red]	[Yellow]	33rd Ave. S.W.	
	Collector	[Green]		[Yellow]	[Red]	[Yellow]	24th Ave. N.W.	
	Industrial Street	[Green]	[Yellow]	[Green]	[Yellow]	[Green]	[Yellow]	53rd Ave. S.E.
	Residential Street	[Green]		[Red]		[Yellow]	Kensington Cl. N.W.	
	Lanes (Alleys)	[Yellow]		[Red]		[Green]		

\* Includes light commercial vehicles, recycling/waste vehicles, etc.  
 \* Emergency services, fire trucks to be accommodated on all street classifications.

- [Green] Accommodated with high standards
- [Yellow] Accommodated with variable standards
- [Red] Not required, or poor performance is acceptable



## 1.5 DIFFERENCES BETWEEN EXISTING AND CTP STREET TYPES

The current Design Guide for Subdivision Servicing has 14 street classifications. The Complete Streets Guide has 13, with some existing street types eliminated, and new street types introduced. Table 1.5-1 provides a translation between the existing and CTP street classification systems.

Table 1.5-1: Existing and CTP street classifications

STREET CLASSIFICATIONS		
CURRENT CLASSIFICATION		CTP CLASSIFICATION
Expressway	Road	Skeletal Road
Major Street (divided)	Arterial	Arterial Street
Major Industrial Street (undivided)		Industrial Arterial
Local Major Street		Local Arterial
N/A	Liveable	Urban Boulevard
N/A		Parkway
N/A		Neighborhood Boulevard
Primary Collector Street (also grand boulevard)	Local	Primary Collector
High Street		Activity Center Street
Collector Street (also connector street, avenue)		Collector
Industrial Street		Industrial Street
Residential Street (also residential entrance street)		Residential Street
Lanes (Alleys)		Lanes (Alleys)



# 2

## Chapter 2 Network Design Guidelines

### 2.1 BENEFITS OF COMPLETE STREETS NETWORK DESIGN

Complete Streets philosophy begins at the highest level of planning detail: the overall arrangement of streets throughout a city, community, or region. At this level, the goal is to create a highly connected network of streets that allow all users to connect within and between neighbourhoods, rather than allowing large vehicle throughways to be barriers between destinations. For the following reasons, a highly connected street network is a powerful tool for improving safety while creating beautiful places and efficient systems:

#### 1. Complete street networks improve traffic safety

Hierarchical street patterns (Arterial-Collector-Local) with cul-de-sac subdivisions depending on Arterials do not perform as well as Complete Streets networks and cause more traffic collisions. Hierarchical street networks divert traffic to high-speed arterials that have large intersections. Most collisions occur at intersections.

Figure 2.1-1: Cul-de-sac developments break up connectivity and create longer trips with small blocks. (Credit: Michele Weisbart)



The speed at which motor vehicles move on these Arterial streets increases the likelihood and severity of collisions. Conversely, grid networks reduce Arterial size, volume, speed, and collisions. A 2011 study of 24 California cities found a 30 per cent higher rate of severe injury and a 50 per cent higher rate of fatalities in cities dominated by sparsely connected cul-de-sacs when compared to cities with dense, connected street networks.

*Reference: (Marshall, W. and Garrick, N., "Does the Street Network Design Affect Traffic Safety?" Accident Analysis and Prevention 43[3]: 769-781).*

A 2009 study from Texas found that each mile of Arterial is associated with a 10 per cent increase in multiple vehicle collisions, a 9.2 per cent increase in pedestrian collisions, and a 6.6 per cent increase in cyclist collisions.

*Reference: (Dumbaugh, E.R. Rae, "Safe Urban Form: Revisiting the Relationship between Community Design and Traffic Safety," Journal of the American Planning Association 75[3]:309-329).*

**Figure 2.1-2: Interconnected street network**  
(Credit: Marty Bruinsma)

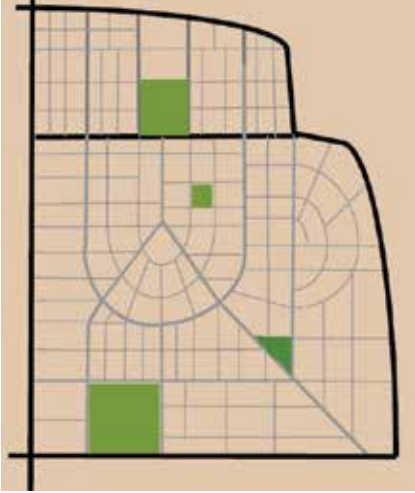

## 2. Complete streets networks reduce vehicle miles travelled and increase the number of people walking and cycling

Connectivity enables people to take shorter routes. It also enables them to travel on quieter streets. These shorter routes on quiet streets are more conducive to cycling and walking. The California study cited above found that places with a dense street network had three to four times more people walking, cycling, or using transit to get to work. This in turn led to a 50 per cent reduction in vehicle miles travelled per capita in these cities.

*Reference: (Marshall, W. and Garrick, N., "The Spatial Distribution of VMT Based upon Street Network Characteristics," 90th Meeting of the Transportation Research Board, Washington, D.C., January 2011).*

Such networks also tend to reduce the walking distance to transit stops, which can improve adoption of transit over private vehicle use.

## 3. Complete streets networks allow more effective emergency response and more efficient delivery of services

Studies in Charlotte, North Carolina, found that when one connection was added between cul-de-sac subdivisions, the local fire station increased the number of addresses served by over 17 per cent and increased the number of households served by 12 per cent. Moreover, the connection helped avoid future costs by slowing the growth of operating and capital costs (salaries comprised the majority of the costs associated with running a fire station). Furthermore, Congress for the New Urbanism's Report on Emergency Response and Street Design found that emergency responders favour well-connected networks with a redundancy of routes to maximize access to emergencies.

*Reference: ("Effect on Connectivity on Fire Station Service Area and Capital Facilities," 2009 presentation by the Charlotte, North Carolina Department of Transportation, [charmeck.org/city/charlotte/citymanager/CommunicationstoCouncil/2009Communications/Documents/CNUPresentation](http://charmeck.org/city/charlotte/citymanager/CommunicationstoCouncil/2009Communications/Documents/CNUPresentation)).*

Research completed by Plan It Calgary noted that improved connectivity facilitated the routing of Calgary Transit, Waste & Recycling Services, and emergency responders, improving efficiency and thereby reducing costs to provide these services.

It has been noted that new community plan applications are showing a trend toward fewer cul-de-sacs and more "fused-grid" (a hybrid network that is neither purely "curvilinear" nor purely "grid") networks.

## 2.2 DESIGNING STREET NETWORKS TO SUPPORT COMPLETE STREETS PRINCIPLES

A street network designed to support Complete Streets principles has the following key features:

1. The public street network gives preference to travel by foot, bike, and transit.
2. The public street network protects, respects, and enhances the city's natural features and ecological systems.
3. The public street network maximizes social and economic activity, and is designed to support the adjacent land uses over mobility for private vehicles passing through the area.

4. The public street network works in harmony with other transportation networks, such as the regional pathway system, separate right-of-way transit systems (e.g., Light Rail Transit), and privately owned networks (e.g., University of Calgary).

The street network works best when it provides a variety of street types. The variety is enforced by the pattern of the street network itself, and also by the design of individual street segments. Natural and built features, including topography and important community destinations, should be taken into account to create unique designs.

In new subdivisions, integrating a network of shared-use paths into the street network should be considered. This type of network allows people to circulate in their communities to schools, parks, stores, and offices while staying primarily on dedicated paths and trails, rather than travelling long distances. These networks can also link paths and trails along

waterways, utility corridors, rail right-of-way, and other more common active transportation corridors, which can provide additional active mode links between communities. High amenity connections allow pedestrians and cyclists to not only travel to their destinations efficiently and comfortably, but to use the network of open spaces, parks, trails and Complete Streets as recreational destinations.

For the City of Calgary, new street networks will use the revised family of streets as described in Chapter 1. Each street type has different characteristics:

- network continuity
- cross-section design
- adjoining land use

It is these different characteristics that give each street type a unique function and context within the overall network of a community.

## 2.3 NETWORK DESIGN GUIDELINES

Good network design can be achieved if the following general guidelines are followed:

1. Establish a block size between 150 – 175 meters in length. Where the block size is exceeded, retrofit large blocks with new streets, alleys, pedestrian and/or bicycle connections. For existing street networks, do not allow street closures that would result in larger blocks.
2. Improve accessibility within a block by providing alleys, service courts, and other access ways.
3. Require multiple street connections between adjacent neighbourhoods. This is achieved by having lower order streets that extend beyond the local area (e.g., Primary Collector).
4. Provide separate connections over or under Skeletal Roads and geographic barriers (rivers, bluffs, rail lines, etc.) so pedestrians and cyclists have links between neighbourhoods without having to travel along intersection ramps and roadways that are not suited to those users.
5. Maintain network quality by accepting growth and expansion of the street network (including development, revitalization, intensifications, or redevelopment) while avoiding increasing the street width or number of travel lanes.
6. Provide on-street curbside parking on most streets. Exceptions to this include very narrow streets, streets with bus lanes, high-speed roads or where there is a better use of the space.
7. Design all streets below an Arterial classification to 50 km/h or less. These speeds promote safety for vulnerable users. For long straight streets, consider traffic controls, narrower lane widths, and boulevard features to reduce driver comfort at speeds over the posted limit.
8. Maintain network function by discouraging:
  - one-way streets;
  - turn prohibitions;
  - full or partial closures (except on bike boulevards, or areas taken over for other public space use);
  - removal of on-street parking (except when replaced by wider sidewalks, an enhanced streetscape, bus lanes, bike lanes, etc. rather than additional vehicle lanes);
  - gated streets/communities;
  - widening of individual streets; and
  - conversion of city streets to limited access facilities.

## 2.4 CONNECTIVITY INDICES

There are two tools available to evaluate the effectiveness of the network to achieve the general guidelines of Section 2.3:

- 1) The Street Connectivity Index
- 2) The Active Modes Connectivity Index

The Street Connectivity Index, shown in Figure 2.4-1, is calculated as the ratio of the street links (streets between intersections with three or more legs, or cul-de-sacs) to the street nodes (intersections with three or more legs, or cul-de-sacs).

The Active Modes Connectivity Index is calculated in a similar manner. For the purposes of this index, Active Modes refers specifically to walking and cycling. All development applications should demonstrate that the connectivity requirements have been achieved for both modes of transportation. A sample Active Modes Connectivity Index calculation is shown in Figure 2.4-2. All types of roads, streets, walkways, and pathways can be used in the calculation. Streets and cul-de-sacs must have a sidewalk on at least one side to be included in the

calculation. For Active Modes Connectivity, cul-de-sacs are not counted as nodes if a walkway or pathway connection is available at the end of the cul-de-sac.

By applying these calculations, a street network can be assessed at the planning level to ensure that the arrangement of streets and pathways in a broad area provides suitable transportation opportunities for all network users.

In general terms, grid pattern networks achieved index scores of 2.0. Conversely, curvilinear networks achieve indices of 1.3-1.4. New community plans should strive for the following targets:

**Activity Centres:**

- 1.7 for streets
- 1.9 for active modes

**Greenfield Residential:**

- 1.4 for streets
- 1.6 for active modes

For more information, consult or download the *City of Calgary Draft Connectivity Handbook* from [www.calgary.ca/ctp](http://www.calgary.ca/ctp)

Figure 2.4-1: Street connectivity index sample calculation

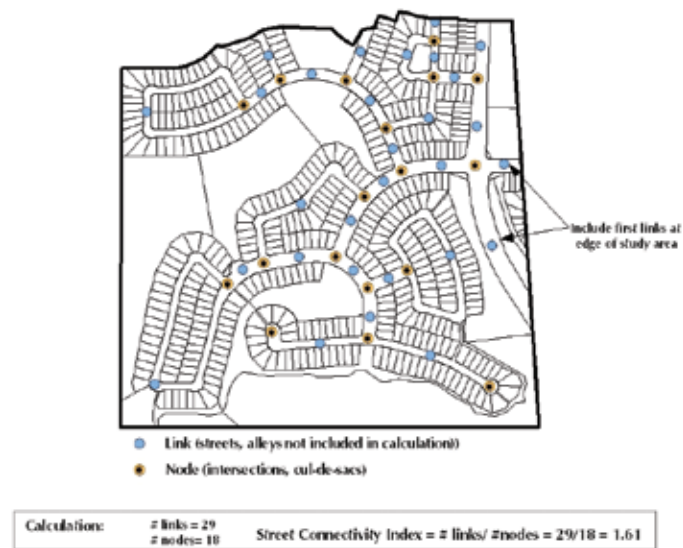

Figure 2.4-2: Active modes connectivity index sample calculation





# 3

## Chapter 3

### 3.1 General

#### 3.1 GENERAL

---

##### 3.1.1 Introduction

Streets and their geometric design have traditionally focused on the movement of motor vehicles, resulting in street environments that overlook other users. This can be seen in streets with wide travel lanes, large corner radii and auxiliary turn lanes, which detract from the convenience and safety of pedestrians and overall connectivity for non-automobile users. This Chapter outlines a shift in approach to street design that is consistent with the Calgary Transportation Plan (CTP). This new approach reorders the priorities within the public right-of-way (ROW) to more directly and effectively serve pedestrians, cyclists and transit riders.

For the purposes of this Guide, roadway design is defined as the part of the street ROW between the curbs, and can include parking lanes, bicycle lanes, transit lanes, general-use travel lanes, and medians. The design of the roadway is critical to the design of the entire street ROW because it affects not only the users in the roadway, but those using areas adjacent to the street.

##### 3.1.2 Street Design Principles

This section covers nine key Complete Streets design principles. Many of the principles revolve around the central theme of lowering vehicular speeds. By lowering the operating speeds, the street environment for pedestrians and cyclists can be improved.

###### 1. Design to Accommodate All Users

Street design should consider all users, including pedestrians, cyclists, transit users, automobiles, and commercial vehicles. A well-designed street provides appropriate space for principle street users to coexist.

Figure 3.1-1: Designed to accommodate all users



**2. Design for Safety – Lower the Design Speed**

The design speed should respect and complement the desired role and function of the street. This includes the type and intensity of land use, urban form, the desired activities on the sidewalk (such as outdoor dining), and the overall safety and comfort of pedestrians and cyclists. The speed of vehicles impacts all users of the street and the liveability of the surrounding area.

Increased safety is the greatest benefit of Complete Streets. Compared with conventionally designed streets, Complete Streets have fewer collisions and high reductions in injuries and fatalities. These dramatic safety benefits are the result of slower speeds for motorists, which provide greater driver awareness, wider fields of vision, shorter stopping distances, and less kinetic energy during a collision. At 30 km/hr or less, chances are very high that a pedestrian will survive and/or not be severely injured in a collision with an automobile. A more organized street environment and designs that cater to pedestrians (e.g., curb extensions for increased pedestrian visibility) contribute to superior safety.

Figure 3.1-2 Peripheral vision decreases at higher speeds. (Credit: Michele Weisbart)

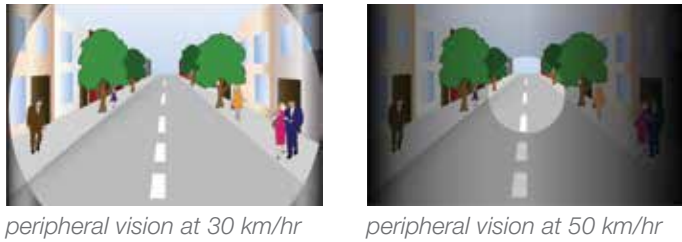

The accommodation and comfort of pedestrians increases greatly at lower speeds. For example, acceptable gaps (i.e., the space between moving vehicles) are better judged at slower speeds. Also, at 40 km/hr or less, drivers are much more likely to yield to pedestrians and let them cross the street than at over 40 km/hr. The chart below (Figure 3.1-3) illustrates how crashes become more severe with speed.

Figure 3.1-3 Pedestrian injury percentage. (Source: Killing Speed and Saving Lives, UK Department of Transportation)

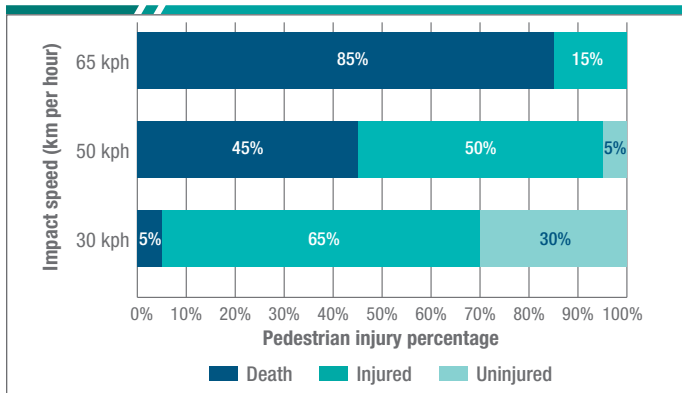

**3. Design for Desired Vehicular Operating Speeds**

The application of design speed for Complete Streets is philosophically different than conventional transportation practices. Traditionally, design speed is set according to speed-flow density curves and aligns with street function for vehicles. This approach has many negative effects. Speed puts all road users at risk, and prioritizes efficiency over access. Local economies thrive on attracting people. Because high design speeds reduce pedestrian and bicycle access, they degrade the social and retail life of a street and devalue the adjacent land.

In contrast, the goal for Complete Streets is to establish a design speed equivalent to desired operating speed that creates a safer and more comfortable environment for motorists, pedestrians, and cyclists. This approach also increases access to adjacent land, thereby increasing its value. For the streets belonging to the Liveable Street family, design/operating speeds of 30 to 50 km/hr are desirable. Alleys and narrow streets intended to function as shared spaces may have design speeds as low as 15 km/hr. A key principle is that street and travel lane width must be set to complement the desired speed for the street environment.

Figure 3.1-4: Don't just sign for desired vehicular speeds, design for it.



Design speed neither determines nor predicts exactly the speed at which motorists will travel on a street segment. Rather, design speed determines the elements and dimensions for the various elements permitted. Features associated with high-speed designs, such as large curve radii, straight and wide travel lanes, ample clear zones (no on-street parking or street trees), guardrails, etc., degrade the walking and cycling experience and make it difficult to design Complete Streets. A slower design speed allows the use of features that enhance the walking environment, such as small curb radii, narrower sections, trees, on-street parking, curb extensions, and street furniture. This is the approach to use for Complete Streets.



#### 4. Design to Accommodate the Largest Vehicles

The design vehicle influences several geometric design features including lane width, corner radii, median nose design, and other intersection design details. In Complete Streets, designing for a larger vehicle than necessary is undesirable, due to the potential negative impacts larger dimensions have on pedestrian crossing distances and the speed of turning vehicles. Alternatively, designing for a vehicle that is too small can result in operational problems if larger vehicles frequently use the roadway.

Figures 3.1-5 a/b: Accommodating largest vehicles



A range of design vehicles to facilitate frequent users is applied given the context of the adjacent development:

- **SU-9** (single-unit truck, front- to rear-axle spacing is 9 m) for Centre City and Activity Centres;
- **WB-19** (semi-trailer truck, front- to rear-axle spacing is 19 m) for local commercial operations;
- **WB-21** (semi-trailer truck, front- to rear-axle spacing is 21 m) for big box (regional commercial) facilities, and
- **Turnpike doubles** (large double semi-truck trailers) for heavy industrial areas.

The design vehicle should be accommodated without encroachment into opposing traffic lanes; however, it is generally acceptable to have encroachment onto multiple same-direction traffic lanes on the receiving street.

For larger, infrequent vehicles, there also needs to be accommodation for basic maneuvering. See Section 3.7.2 for more information on corner radii.

#### 5. Design With Appropriate Travel Lane Widths

Travel lane widths should be determined based on the context and desired speed for the area in which the street is located. Lane width selection should be based on:

- design/desired speed;
- context/location (e.g., 3.7 m lanes should be provided on Primary Goods Movement network, 3.5 m lanes on Primary Transit network, 3.3 m lanes on Liveable Streets), and
- bicycle facility requirements.

For drivers to regulate driving speed, lane widths have to create some level of discomfort when driving too fast. Narrow lanes and the presence of on-street parking can aid in speed reduction (see Figures 3.1-6 and 3.1-7). Rear lane (alley) ROW width should be a minimum of 7 m with no permanent structures located within the ROW that would interfere with vehicle access to garages or parking spaces, access for recycling and waste collection, and other operational needs. The vehicular lane widths used for Complete Streets are based on a survey of municipal practices in North American 'winter cities' and were approved by the Complete Streets Steering Committee in May 2011.

Figure 3.1-6: Wide two-lane streets encourage speeding



Figure 3.1-7: Narrower two-lane streets discourage speeding (Adapted from: Michael Ronkin)



## 6. Design to Accommodate On-Street Parking

On-street parking is important for the success of retail businesses that line the street, to provide a buffer for pedestrians and to help calm traffic speeds. On-street parking occupies about half the surface area per car compared to off-street spaces, which require driveways and aisles for access and maneuvering.

Figure 3.1-8: On-street parking adjacent to retail uses



In occasional cases where angle parking is proposed for on-street parking, designers should consider the use of reverse-in angle (or front out) parking in lieu of front-in angled parking. Motorists pulling out of reverse-in angled parking can better see the street they are entering, which is especially important to cyclists. Note that this practice will not be widely accepted within The City of Calgary unless revisions to the Traffic Bylaw and Calgary Parking Authority enforcement practices are made.

Appropriate proportion of accessible stalls needs to be provided in areas with street parking. Details for the design of accessible stalls and their relationship/access to sidewalks have yet to be developed. Refer to Alberta Building Codes for accessible parking stalls. Refer to section 122 of The City of Calgary Land Use Bylaw (1P2007) for the rules on all other parking stall dimensions.

## 7. Design With Turn Lanes Only if Appropriate

Turn lanes tend to allow higher speeds to occur through intersections, since turning vehicles can move over to the turn lane, allowing the through vehicles to maintain their speed. Therefore, the need for vehicle turn lanes should be balanced with the need to manage vehicle speeds, both of which impact other elements within the ROW such as sidewalk and green infrastructure width. Pedestrian and cyclist comfort and safety when interacting with turn lanes is also a major consideration.

Left turn lanes are acceptable in certain circumstances in Calgary's urban environment, since there are negative impacts to roadway capacity when left turns block the through movement of vehicles. Sometimes just a left turn pocket (just long enough for one or two cars) is sufficient. The installation of a left turn lane can also be beneficial when used to perform a "road diet" such as reducing a four-lane section to three lanes, with the centre lane providing for turning movements in both directions.

Figure 3.1-9: Street where turn lanes would not be appropriate



The applicability of right turn lanes is different than left turn lanes. While right turns from through lanes may delay through movements, they also create a reduction in speed due to the slowing of turning vehicles. The installation of right turn lanes increases the crossing distance for pedestrians. Therefore, exclusive right turn lanes should rarely be used except at "T" intersections. When used, they should be mitigated with raised channelization islands. See Section 3.7.2 for more information.

## 8. Design With Medians

Medians on urban streets provide access management, by limiting left turns into and out of abutting development, to locations where a separate left turn lane or pocket can be provided. The resulting reduced frequency of conflicts and number of conflict points decrease the likelihood of collisions. Medians also provide pedestrians with a refuge as they cross the street, and create space for landscaping, lighting, and utilities. Landscaped medians can enhance the street or help to create a gateway entrance into a community. Medians are usually raised and curbed.

Median width varies and should be based on:

- design/posted speed;
- pedestrian accessibility and waiting requirements;
- requirements for turning lanes;
- green infrastructure requirements;
- available right of way and
- the street classification/function.

Figure 3.1-10: Well-designed street medians bring multiple benefits  
(Credit: Dan Burden)



Because medians require a wider ROW, the designer must weigh the benefits of a median with the issues of pedestrian crossings (namely crossing distance and speed), land-use context, and available boulevard width. It is a desirable design practice, in conjunction with reduced travel lane width, to incorporate raised medians (preferably with low-maintenance landscaping) into the design of streets, as they visually narrow the roadway. This is not applicable to Skeletal Roads.

## 9. Design With Appropriate and Well-Utilized ROW Width

The selection of ROW width is a critical decision because the competing requirements of the cross-section elements must be considered, and ROW in new development areas takes up a major portion of the developer's raw land. The economic requirements for the development are therefore a key part of the right-of-way equation. When considering ROW in Calgary, "Greenfield" and redevelopment areas, the following are key considerations:

- ROW width should be set to complement multi-modal (vehicular, bicycles, pedestrians) facility function.
- Horizontal and vertical zones should be designated for placement and development of all elements (buried, overhead, and on the surface) required within the corridor.
- When minimum ROW is utilized, additional building setback (e.g., 1.5-4.5 m) and easements should be provided if possible, based on the Land Use Bylaw.
- Where sufficient spacing within a ROW does not exist for sidewalks, bicycles and parking, priority should be given first to sidewalks, then to bicycles to meet the minimum widths set out in The City's Design Guide for Subdivision Servicing (DGSS) for each street classification.
- Where sufficient space within a ROW does not exist for sidewalks and green infrastructure, priority should be given to sidewalks to meet the minimum widths set out in the DGSS for each street classification.

Figure 3.1-11: Good boulevard design incorporating pedestrian space, parking and green infrastructure



### 3.1.3 Geometric Design Standards

Traditional geometric design standards for roads cater to moving vehicular traffic at high speeds. To create Complete Streets, these are elements of geometric design to consider that support sustainable or multi-modal design:

#### 1. Vertical Alignment

The Transportation Association of Canada (TAC) Geometric Design Guide provides acceptable values for designing vertical curves for Complete Streets. The values used in vertical curve design should be selected based on the design speed appropriate for the street. Using higher values can contribute to increased vehicle speeds and may require increased modification to the natural terrain, thereby increasing negative impacts to the natural environment.

Figure 3.1-12: Vertical alignment



#### 2. Horizontal Alignment

The TAC Geometric Design Guide provides appropriate values for designing horizontal curves for Complete Streets. The values used in horizontal curve design should be selected based on the design speed appropriate for the street. Using higher values can contribute to increased vehicle speeds and also impacts the character of the street. Larger horizontal curves also create a more “suburban” or “rural” highway feel.

Figure 3.1-13: Horizontal alignment



### 3. Stopping Sight Distance

The TAC Geometric Design Guide provides appropriate values for designing stopping sight distance for Complete Streets. In addition, the 2004 AASHTO Guide for Achieving Flexibility in Highway Design is based on the latest research concerning the establishment of stopping sight distance. The document states that the established values for stopping sight distance are very conservative and provide adequate flexibility without creating increased crash risk. Consequently, appropriate design speed selection is critical to avoid overly negative impacts, such as unnecessarily limiting on-street parking and tree planting.

Figure 3.1-14: Stopping sight distance



### 4. Intersection Sight Distance

Intersection sight distance should be calculated in accordance with the TAC Geometric Design Guide using the design speed appropriate for the street being evaluated. When crossing or turning onto a street after stopping at a stop sign, stop bar, or crosswalk, drivers will move slowly forward to obtain sight distance (without intruding into the crossing travel lane), stopping a second time as necessary. Therefore, when curb extensions are used or on-street parking is in place, the vehicle can move forward on the second-step movement, stopping just shy of the travel lane, increasing the driver's potential to see further than when stopped at the stop bar. As a result, the increased sight distance provided by the two-step movement allows parking to be located closer to the intersection.

Figure 3.1-15: Intersection sight distance

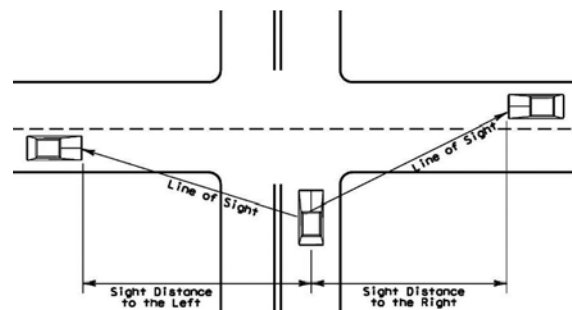



## 5. Horizontal Clearance/Clear Zone

Horizontal clearance is the lateral distance from a specified point on the roadway, such as the edge of the travel lane or face of the curb, to a public realm feature or object. In rural suburban areas, the clear zone is the relatively flat, unobstructed area that is provided for safe operations and use by errant vehicles. In urban areas, clear zone requirements are unnecessary.

Urban areas are characterized by more cyclists and pedestrians, lower operating speeds, more dense abutting development, closer-spaced intersections and accesses to property, higher traffic volumes, and restricted ROW. Therefore, streets with curbs and gutters in urban areas do not have sufficiently wide public realm zones to provide broad clear zones. Consequently, while there are specific horizontal clearance requirements for these streets, they are based on clearances for normal operation. The minimum horizontal clearance to a fixed object is 0.5 m measured from the face of the curb. This is primarily intended for signposts and poles, to ensure they are not hit by large vehicles with over hangs close to the curb.

Figure 3.1-16: Horizontal clearance



## 6. Travelled Way Lighting

Lighting has a large impact on safety, with pedestrians and cyclists being disproportionately struck at poorly lit crossings when visibility is poor: at dusk, night, and dawn. Providing illumination or improving existing lighting increases night-time safety at intersections and mid-block crossings, while pedestrian-scale lighting along sidewalks provides greater security, especially for people walking and cycling alone at night.

Transit stops require both kinds of lighting: strong illumination of the travelled way for safer street crossing, and pedestrian scale illumination at the stop or shelter for security. If there are bus stops between roadway sections, it is necessary to illuminate the roadway and the bus stop.

Figure 3.1-17: Travel way lighting





# Chapter 3

## 3.2 Pedestrian Design

### 3.2 PEDESTRIAN DESIGN

---

Walking is the most basic mode of transportation, and cities must provide amenities to make it easy for people to walk. Certain areas generate high pedestrian activity, such as the downtown, transit hubs, commercial and entertainment districts, multi-family residential areas and schools. Yet even in areas of low pedestrian activity, pedestrian needs and safety must remain a priority.

#### 3.2.1 Pedestrian Policy (TP-010)

The City of Calgary has a Council-approved Pedestrian Policy and Needs Report (TP-010) that provides pedestrian design guidance. The intent of this policy is to:

- Reaffirm the importance of walking as an efficient, non-motorized choice of transportation;
- Establish broad, city-wide policies that provide direction and guidance on how to plan, design, build, operate and maintain a city where walking is a meaningful form of transportation for social and economic activities.

#### **POLICY STATEMENT:**

The City of Calgary will use the following policies to support walking as a year-round, convenient and obstruction-free mode of transportation that is accessible regardless of age, gender, income, culture or ability:

1. Plan and build compact, mixed-use communities.
2. Give priority to the planning, design, implementation and operation of pedestrian routes and facilities with the planning and design of all land use and transportation planning objectives.
3. Improve existing pedestrian routes and facilities, and build missing links along those routes.
4. Design facilities, educate the public, and enforce laws to increase acceptance and understanding, and decrease conflicts amongst the users of pedestrian facilities.
5. Ensure pedestrian routes receive priority during everyday maintenance and yearly facility improvement programs.
6. Provide pedestrian routes that are engaging and safe, and that feel secure.

The Pedestrian Policy and Needs Report identifies the basic transportation needs of pedestrians and is based on best practices from North America and Europe. The policies and needs will be used in several areas, including the development process, capital projects, pedestrian projects, maintenance and replacement activities, planning and prioritization. The 2008 Council-approved Policy and Needs Report can be found by entering “Pedestrian Policy” on the main page of [www.calgary.ca](http://www.calgary.ca).

### 3.2.2 Access Design Standards

The Calgary Corporate Accessibility Policy (CSPS003), approved by Council in 2005, directs Administration to follow the latest edition of the City of Calgary Access Design Standards in all City projects. The purpose of the standards are to create a more liveable and accessible city for people with mobility issues. This is accomplished by increasing the awareness of the needs of those citizens, and providing design solutions that increase and enhance access to the outdoors throughout the year. These standards were created by an Advisory Committee on Accessibility (ACA), consisting of members with disabilities, representatives from the community and representatives from several City of Calgary business units.

These standards apply within the property boundaries of City-owned and operated buildings and facilities. Construction within road rights-of-way will require consultation with appropriate City departments in addition to these standards. The City of Calgary Access Design Standards can be downloaded at: [http://www.calgary.ca/PDA/DBA/Documents/development/access\\_design\\_standards.pdf](http://www.calgary.ca/PDA/DBA/Documents/development/access_design_standards.pdf).

The ACA strongly supports the Pedestrian Design Guidelines found later in this section, specifically those related to wider sidewalks, sidewalks on both sides of the street, and two wheelchair ramps at each intersection corner.

Figure 3.2-1: Accessible design



### 3.2.3 Safety and the Walking Environment

An effective method of improving safety for all travellers, including the most vulnerable (children, people with disabilities and older pedestrians), is to decrease vehicle speed. At reduced speeds, drivers are more attentive to activity on the side of the street, reaction time is increased, improving pedestrian safety. Most pedestrian collisions occur when a person crosses the street, and the most common collision type is a conflict between a crossing pedestrian and a turning vehicle at an intersection. Design interventions can reduce the incidence of conflict between pedestrians and vehicles.

While safety is the key goal, the main objective of street and intersection design for pedestrians should be to create an environment that is conducive to walking and crossing the street with ease, and to create a public space where people want to be. The two most effective methods to achieve these goals are:

1. Minimize the footprint dedicated to motor vehicle traffic.
2. Slow down the speed of moving traffic.

This approach allows the design to use many features that enhance the walking environment, including trees, curb extensions, and street furniture, all of which slow traffic. All streets should have sidewalks, except for rural roads and shared-space (between vehicles and pedestrians) streets.

Figure 3.2-2: Safe for children





### 3.2.4 Pedestrian Design Principles

The key principles of pedestrian design (from the Pedestrian Policy and Needs Report) include:

1. Connectivity and convenience.
2. Space to travel.
3. Routes free of obstructions.
4. Character and a feeling of security and safety.

#### DESIGN PRINCIPLES ALONG THE STREET

##### 1. Zone Widths

Sidewalk (or public realm) space can be broken down into four zones:

**Edge:** closest to the curb; may contain parking meters, car door swing paths, trees, vegetation and snow storage. Bike lanes and parked cars serve as physical and psychological buffers.

**Furniture:** may include streetlights, fire hydrants, signs, trees, newspaper boxes, recycling and waste receptacles, bike racks, benches, and transit shelters.

**Sidewalk:** the space available for pedestrian travel.

**Frontage:** farthest from the curb; includes the space from a drop-off or horizontal obstruction; provides space for stopping/window shopping.

The width required for each zone depends on the land use and pedestrian activity levels. For example, in areas with high pedestrian volumes such as an employment center, greater throughway widths are required. A smooth surface and an absence of obstructions are required for pedestrian travel in the clear zone. Signage, traffic control equipment, utility elements, landscaping, street furniture and fences must be located outside of the clear zone. Tree grates, parkade grates and interlocking pavers are best placed in the furniture or frontage zone.

Figure 3.2-3: Public realm zones – Marda Loop area, 33rd Avenue S.W.

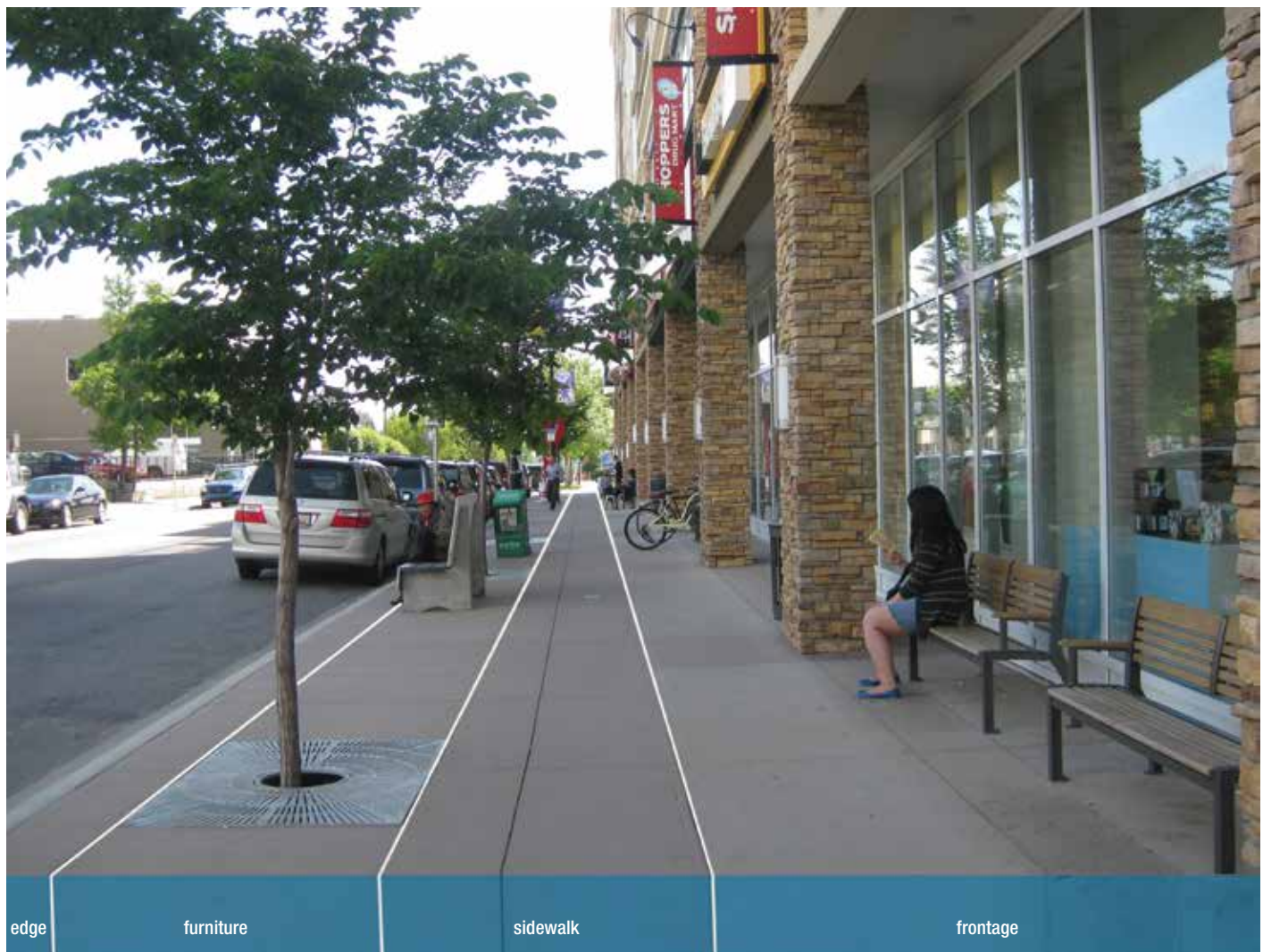

## 2. Driveway Crossings

At driveway crossings, driveway aprons that extend into the pedestrian zone can render a sidewalk impassable to users of wheelchairs, walkers and crutches. They need a flat plane on which to rest all four supports (two in the case of crutches). To provide a continuous pedestrian route across driveways, aprons should be confined to the furniture and curb zones (*Ref: Living Streets Manual Pg. 6-9*).

Figure 3.2-4: Driveway aprons require a flat plane.



## DESIGN PRINCIPLES FOR CROSSING THE STREET

### 1. Crosswalks

Crosswalks and ramps at intersections should be placed so they provide convenience and safety for pedestrians. The following recommended practices help to achieve these goals:

- Allow crossings on all intersection legs, unless there are no pedestrian-accessible destinations on one or more of the corners;
- Provide marked crosswalks at signalized intersections;
- Place crosswalks as close as possible to the desired line of pedestrians. Generally, this is in alignment with the approaching sidewalks;
- Provide as short as possible crossing distances (at right angles across the roadway wherever possible) to reduce pedestrian exposure time to motor vehicles.

Crossings are required where pedestrian routes intersect roads. A 'safe' crossing that no one uses serves no purpose. If people are routinely crossing streets at non-preferred locations, consideration should be given to installing a new crossing. There must be a safe, convenient crossing at every transit stop (*Ref: Living Streets Manual, Chapter 7*).

## Markings

The majority of crosswalks in Calgary are painted as horizontal lines. A small percentage (approximately 700 locations) of crosswalks are painted "ladder" style. Ladder crosswalks are used in very specific locations such as elementary school crossings. This type of crosswalk is becoming more popular because it is more visible than horizontal style crosswalks.

A third, and most visible, treatment (not currently used in Calgary) are diagonal markings within horizontal lines.

Figure 3.2-5: Crosswalk pavement markings  
(FWHA, *Sidewalk Design Guidelines*)

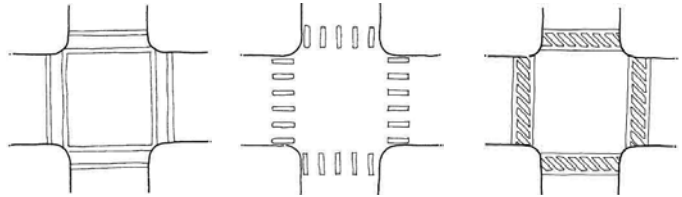

## Crosswalk Control Devices

Most crosswalks in Calgary are either uncontrolled with signage and pavement markings, or located at signalized intersections. When warranted, The City also installs "pedestrian corridors" – pedestrian activated overhead yellow flashing lights as shown in Figure 3.2-6. Pedestrians have the right of way when lights are activated.

Figure 3.2-6: Pedestrian corridor – Canyon Meadows Drive S.E.



Recently, The City has installed solar-powered Rectangular Rapid Flash Beacons (RRFB) at pedestrian crossings. The beacons have LED lights and display intermittent rapid

flashes when activated by a pedestrian. These devices are significantly less costly to install and operate compared to the conventional overhead flashing beacons currently in use at most pedestrian corridors in Calgary.

Figure 3.2-7: Rectangular rapid flash beacon



## 2. Curb Extensions

Curb extensions extend the sidewalk or curb line out into the parking lane, which reduces the effective street width. Curb extensions significantly improve pedestrian crossings by reducing the pedestrian crossing distances, visually and physically narrowing the roadway, improving the ability of pedestrians and motorists to see each other, and reducing the time that pedestrians are in the street. Curb extensions can be located at intersections or mid-block.

Where on-street parking is allowed, curb extensions should be considered to replace the parking lane at crosswalks on Liveable Streets (and some Local Streets). Curb extensions should be the same width as the parking lane where possible (see Figure 3.2-8). On collector streets with traffic volume less than 3,000 vpd and residential streets, a minimum pavement width of 7m between curb extensions should be maintained. The appropriate corner radius should be applied based on information in Section 3.7.2. Due to reduced street width, the corner radius on a curb extension may need to be larger than if curb extensions were not installed.

Figure 3.2-8: Integrating curb extensions and on-street parking into the sidewalk corridor enhances pedestrian safety and the walking experience (Credit: Michele Weisbart).



## 3. Curb Ramps

Curb ramps provide access for people in wheelchairs or scooters at crossings where there is an elevation change between a sidewalk and a street level crossing. Each crosswalk should have a curb ramp at each end and not be shared (e.g., two per corner for standard intersections as shown in Figure 3.2-7). Ramps must be entirely contained within a crosswalk (the crosswalk can be flared to capture a ramp that cannot be easily relocated). Where possible, align the ramp run with the crosswalk, as ramps angled away from the crosswalk may lead some users into the intersection. At intersections where streets are skewed or where larger radii are necessary for trucks, it can be difficult to determine the best location for crosswalks and sidewalk ramps. In these situations, it is important to balance the recommended practices above. Tighter curb radii make implementing these recommendations easier.

Figure 3.2-9: Appropriate ramp placement



## 4. Raised Crossing Islands/Medians

Raised islands and medians are the most important, safest and most adaptable engineering tool for improving street crossings. They allow pedestrians to cross in two stages.

Figure 3.2-10: Raised median allows for pedestrian refuge (Banff Avenue, Banff, AB).





Angled pedestrian crossings through pedestrian refuges force pedestrians to look for oncoming vehicles. The minimum width of a crossing island is 1.8 m. On higher-speed roads, a 45-degree bend to the right through the median will help orient pedestrians to the risk they encounter from motorists during the second half of their crossing.

Figure 3.2-11: Angled median crossing (Credit: ite.org)

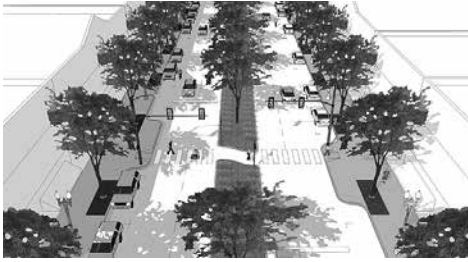

### 5. Raised Crosswalks

The level crosswalk area must be paved with smooth materials. Any texture or special pavements used for aesthetics should be placed on the bevelled slopes, where they (Ref. 7-12) will be seen by approaching motorists (Ref. 7-13). They are especially effective near elementary schools, where they raise small children by a few inches and make them more visible (Ref. Pg. 7-13).

Figure 3.2-12: Raised crosswalk



### 6. Mid-block Crosswalks

Crosswalks situated at controlled intersections often don't provide enough cross-street pedestrian connectivity. In the appropriate location, mid-block crosswalks can be used when the spacing between intersections is large, there is a need to connect uses on either side of a street, or there is an existing pedestrian route perpendicular to the street. As figures 3.2-13 and 3.2-14 illustrate, curb extensions should always be used in conjunction with mid-block crosswalks.

Figure 3.2-13: Typical mid-block crosswalk design

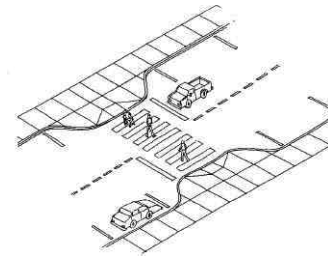

Figure 3.2-14: Mid-block crosswalk with median refuge



### 7. Pedestrian Overpasses

Pedestrian overpass structures are not preferred because of their high capital cost (>\$2 million) but are sometimes necessary to cross pedestrians (and cyclists) over wide, high-volume, high-speed Arterial Streets and Skeletal Roads.

Figure 3.2-15: Pedestrian overpass on Crowchild Trail



## 8. Crosswalk Materials

Decorative crosswalk pavement materials should be chosen with care to ensure that smooth surface conditions and high contrast with surrounding pavement are provided. Textured materials within the crosswalk are not recommended. Without reflective materials, these treatments are not visible to drivers at night. Decorative pavement materials often deteriorate over time and become a maintenance problem while creating uneven pavement (*Living Streets Manual, Ref. Pg. 7-9*). Uneven pavement can also occur where cuts for utility work are commonly repaired with asphalt patches.

Figure 3.2-16: Appropriate crosswalk material



## 9. Advanced Stop Lines

Advanced stop lines reduce vehicle encroachment into the crosswalk and improve the driver's view of pedestrians (*Ref. Pg. 7-16*).

Figure 3.2-17: Advanced stop lines



## 10. Lighting

Lighting should be present at all marked crossing locations. Lighting provides early cues to drivers to expect pedestrians. Illumination just in front of the crosswalk creates optimal visibility of pedestrians (*Ref. Pg. 7-17*).

Figure 3.2-18: Crosswalk illumination



## 11. Crosswalk Closures

Closed crosswalks create discontinuous pedestrian routes and make walking inconvenient. Crosswalk closures are used to safeguard pedestrians in the face of very high traffic volumes or speeds and auto-oriented design. Many pedestrians, however, ignore crosswalk closures to reach a destination faster despite the high safety risk.

Figure 3.2-19: Closed crosswalk – 3rd Ave NW, Parkdale Community



New crosswalk closures should be avoided. Mitigative measures such as pedestrian actuation and signal timing changes should be explored first. Existing closed crosswalks should be evaluated for opening through site-specific analysis (e.g., transportation impact studies (*Source: Better Streets Plan, San Francisco*)).



### 3.2.5 Pedestrian Design Guidelines

The following guidelines should be used for the planning, design, and construction of sidewalks in the City of Calgary:

1. Separated sidewalks should be a minimum 1.5 m wide (all classifications).
2. Monolithic sidewalks should be a minimum 2 m wide for improved pedestrian safety and to provide adequate width for snow storage (1.5 m permitted on residential and industrial streets).
3. Sidewalks should be provided on both sides of all street classifications (including most residential and industrial areas) with the exception of Skeletal Roads.
4. Sidewalks wider than 2 m should be provided along transit routes and connections to transit hubs.
5. Sidewalks wider than 2 m should be provided for connections to schools, within activity centres and near major pedestrian generators (e.g., stadiums).
6. If monolithic, sidewalks should be wider than 2 m to provide separation from traffic when:
  - a) truck volumes are greater than 10 per cent of total volume.
  - b) design speed is greater than 60 kilometres per hour.
  - c) traffic volume is greater than 20,000 vehicles per day (note: does not apply to industrial streets).
7. Sidewalk widths should be determined based on surrounding land uses (higher density requires wider sidewalks).
8. Ideally, two directional wheelchair ramps should be installed at ALL street intersection corners (if corner radii and catch basin locations permit). As a minimum, all Arterial, Liveable, Primary Collector, Collector, and Activity Centre Streets should have two wheelchair ramps at each corner.

# Chapter 3

## 3.3 Bikeway Design

### 3.3 BIKEWAY DESIGN

---

A Bikeway Design Guide is being developed in 2014-2015 by the Transportation, Planning and Roads business units. Development of this Guide is an action (C4) of the Council-approved City of Calgary Cycling Strategy. In the meantime, The City of Calgary has some bicycle design guidance from the Council-approved Bicycle Policy and Needs Report (TP-011).

#### 3.3.1 Bicycle Policy (TP-011)

The City of Calgary has a Council-approved Bicycle Policy and Needs Report (TP-011). The intent of this policy is to:

- Reaffirm the importance of cycling as an efficient, non-motorized choice of transportation.
- Establish broad, city-wide policies that provide direction and guidance on how to plan, design, build, operate and maintain a city where cycling is a meaningful form of transportation for social and economic activities.

#### **POLICY STATEMENT:**

The City of Calgary will use the following policies to support cycling as a year-round, convenient and obstruction-free mode of transportation that is accessible regardless of age, gender, income, culture or ability:

1. Plan and build compact, mixed-use communities.
2. Give priority to the planning, design, implementation and operation of bicycle routes and facilities with the planning and design of all land use and transportation objectives.
3. Improve existing bicycle routes and facilities, and build missing route links.
4. Design facilities, educate the public, and enforce laws to increase acceptance and understanding, and decrease conflicts among road and pathway users.
5. Give priority to the maintenance of bicycle routes and facilities.
6. Provide bicycle routes that are safe, feel secure, and are of engaging character.
7. Provide bicycle parking and other amenities at destinations.
8. Ensure that bicycle facilities are included in the design and operation of City facilities (e.g., Calgary Transit and City-owned buildings).

The Bicycle Policy and Needs Report identifies the basic transportation needs of cyclists and is based on best practices from North America and Europe. The policies and needs will be used in several areas including the development process, capital projects, bicycle projects, maintenance and replacement activities. These policies and needs will inform the creation of a Bikeway Design Guide for Calgary. The 2008 Council-approved Policy and Needs Report can be downloaded by entering “Bicycle Policy” on the home page of [www.calgary.ca](http://www.calgary.ca). The 2011 Council-approved Cycling Strategy can be downloaded by entering “Cycling Strategy” on the same home page.

### 3.3.2 Bikeway Design Principles

All streets, whether new or retrofit, should be designed with the expectation that cyclists will use them. This does not mean that every street needs a dedicated bicycle facility, nor will every street accommodate all types of cyclists. However, in order to support the goals laid out in the Cycling Strategy (e.g., more people cycling, more bicycle infrastructure, safer cycling and increased satisfaction with cycling) and the Calgary Transportation Plan, a bikeway network must be designed that accommodates those Calgarians who want to cycle, but currently do not feel safe cycling on-street (i.e., “Interested cyclists”).

Figure 3.3-1: Categories of Calgary Cyclists (Source: The City of Calgary Cycling Strategy Research Public Telephone Survey 2011)

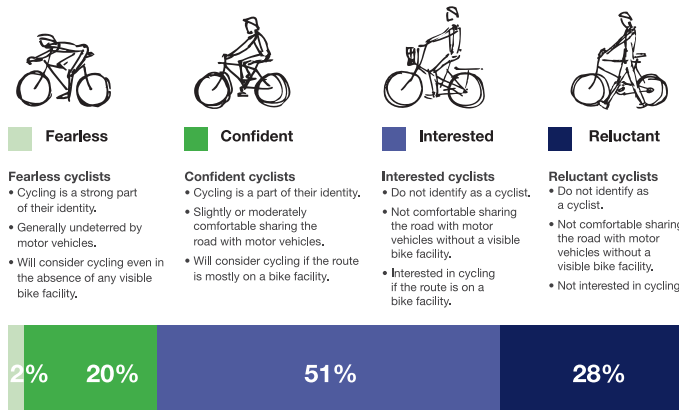

Minimizing the footprint dedicated to motor vehicle traffic and slowing down the speed of moving traffic benefits cyclists. Ideally, all multi-lane streets should have cyclist-specific accommodation that is appropriate to the context of that street (e.g. bike lanes, separated bike lanes, multi-use pathways).

### 1. Shared Bicycle/Vehicle Lanes (Sharrow)

Sharrows, representations of a bicycle with two chevrons above it, are a symbol to indicate that motor vehicles and bicycles are to share the lane. The purpose is to steer cyclists to the safer section of the road (in the centre of the sharrow and away from the door zone of parked cars), and discourage cyclists from riding on the sidewalk or against traffic.

Figure 3.3-2: Shared travel/bike lane (Source: Beaconarts.org)



## 2. Conventional Bike Lanes

A bike lane is defined as a portion of the roadway that has been designated by striping, signage, and pavement markings for the preferential or exclusive use of cyclists. Bike lanes facilitate predictable behaviour and movements between bicyclists and motorists and enable cyclists to ride at their preferred speed without interference from prevailing traffic conditions. A bike lane is distinguished from a cycle track in that it has no physical barrier (bollards, medians, raised curbs, etc.) that restricts the encroachment of motorized traffic. Conventional bike lanes run curbside when no parking is present, adjacent to parked cars on the right-hand side of the street, or on the left-hand side of the street in specific situations. Bike lanes typically run in the same direction of traffic, though they may be configured in the contra-flow direction on low-traffic corridors necessary for the connectivity of a particular bicycle route.

Figure 3.3-3: Bike lane (Source: NACTO)



## 3. Buffered Bike Lanes

Buffered bike lanes are conventional bicycle lanes paired with a designated buffer space separating the bicycle lane from the adjacent motor vehicle travel lane and/or parking lane.

Figure 3.3-4: Bike lane buffered from parking lane and travel lane (Source: NACTO)



bike travel lane



buffered bike lane

## 4. Cycle Tracks

One-way protected cycle tracks are bikeways that are at street level and use a variety of methods for physical protection from passing traffic. A one-way protected cycle track may be combined with a parking lane or other barrier between the cycle track and the motor vehicle travel lane.

Two-way cycle tracks (also known as protected bike lanes, separated bikeways, and on-street bike paths) are physically separated cycle tracks that allow bicycle movement in both directions on one side of the road. Two-way cycle tracks share some of the same design characteristics as one-way tracks, but may require additional considerations at driveway and side-street crossings. A two-way cycle track may be configured as a protected cycle track at street level with a parking lane or other barrier between the cycle track and the motor vehicle travel lane to provide vertical separation from the adjacent motor vehicle lane.

Figure 3.3-5: One-way and two-way cycle tracks. (Source: NACTO)



one-way cycle track



two-way cycle track

## 5. Multi-Use Pathways

The City of Calgary has over 700 km of regional (or multi-use) pathway in the City. Approximately 500 km is found along the river valleys and linear parks throughout the city. The remainder is within road ROW. As a new bicycle facility, roadside multi-use pathways are discouraged, particularly in areas with frequent intersections or driveways. Drivers can better anticipate cyclists if they are on the road. If pathways are built, the minimum permitted width is 3 m.

Figure 3.3-6: 3 m regional pathway in a park, Calgary, AB



### 3.3.3 Bikeway Design Guidelines

The following guidelines should be used for the planning, design, and construction of bicycle facilities in the city of Calgary:

1. The type of bicycle facility should be determined based on:
  - bicycle network connectivity (as specified in the City of Calgary Pathway and Bikeway Implementation Plan);
  - current and future demand for a route;
  - cycling policies (e.g., Bicycle Policy TP-011);
  - design/posted motor vehicle speed;
  - surrounding land uses;
  - driveway frequency;
  - level of transit service (e.g., frequent BRT vs. infrequent bus); and
  - daily traffic volume and composition.
2. Collector streets carrying more than 3,000 vehicles per day shall include dedicated bike lanes.
3. Minimum bike lane width is 1.5 m free of obstructions and obstacles (1.2 m may be permitted in retrofit projects where there are constraints).
4. Wider on-street facilities (e.g., 1.5 m min. bike lane + 0.8 m min. buffer) shall be provided adjacent to a parking lane (door zone buffer), next to vertical barriers and on a grade (as cyclists may not travel in a straight line while travelling uphill).
5. A buffered (e.g., min 1.0 m painted or textured buffer) or physically separated (e.g., by a curb or parked vehicles) exclusive facility should be provided when any of the following criteria are met:
  - a) truck volumes are >10 per cent of total volume
  - b) design speed is >60 km/hr
  - c) two-way traffic volumes exceed 20,000 vehicles per day
  - d) the speed differential between cyclists and motor vehicles is too great (e.g., when traveling uphill)
6. Minimum width for regional pathways is 3.0 m (uplands) and 4.0 m (river and creek valleys).

These guidelines have been used to ensure that all street cross-sections and intersection plans in this Guide and the latest Design Guide for Subdivision Servicing provide for bicycle facilities.

The Bikeway Design Guide (to be developed) will provide additional detailed design guidance.



# Chapter 3

## 3.4 Transit Design

### 3.4 TRANSIT DESIGN

#### 3.4.1 Introduction

Complete Streets make transit an attractive travel choice by offering safety, comfort, accessibility, and the convenience of faster and more direct service to passengers' destinations.

These benefits attract riders, decrease operating costs, and increase system efficiency. To achieve transit friendliness on Complete Streets, the following design considerations should be reflected:

- **Road network design** – Design efficient road networks with good connectivity that enable transit to operate efficiently and offer accessible and attractive transit service for Calgarians.
- **Pedestrian network** – Provide pleasant and efficient pedestrian connections within and between communities, and provide convenient access to transit stops.
- **Transit priority** – Build infrastructure that provides priority for transit operations and allows transit service to perform effectively and efficiently.
- **Stop design** – Create pleasant and safe waiting environments for transit customers, which are well-integrated into complete neighbourhoods.

Figure 3.4-1: The critical elements for designing a transit system





### 3.4.2 Network Design

The underlying objective for Calgary Transit, as outlined in the Calgary Transportation Plan (CTP), is to: “provide a safe, accessible, customer-focused public transit service that is the preferred mobility choice of Calgarians.” Design of roadway networks, communities and routes plays a critical role in achieving this objective.

Good network design can be achieved by applying the following planning principles:

#### 1. Provide a Street Network that Enables Simple Transit Routes

Transit service that is indirect or is circuitous negatively affects service and customer experience. Turning corners or making unnecessary diversions away from main corridors means service is not direct (creating longer travel time), is less reliable, and more expensive to operate. Direct routes are easier for customers to understand, which is important for attracting new riders.

Figure 3.4-2: Simple routes offer a fast and attractive service.

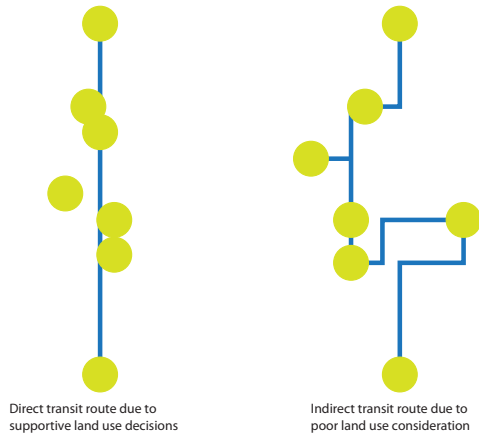

The following examples from Calgary illustrate how street networks influence transit route ridership and coverage. These different locations show how transit connectivity is affected by network design. The maps show identical land area, but the greater number of inter-community connections on the left allows for a greater number of transit connections. Communities with fewer connections have isolated transit routes, making transferring between routes difficult.

#### 2. Ensure Walkability

Transit customers are also pedestrians. They represent a complete street cross-section of the population and reflect a full range of mobility levels. Transit stops must allow for all customers to arrive and depart transit stops safely, securely, and comfortably.

In Calgary, the goal is to locate transit stops within approximately 400 m or five minutes’ walking distance

Figure 3.4-3: Transit network design is correlated with and dependent on road network design.

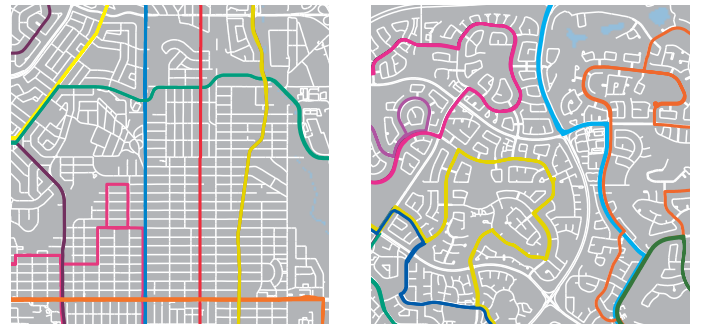

NORTH CENTRAL CALGARY	NORTHWEST CALGARY
Direct, simple routes	Long, circuitous routes
Shorter transit travel times	Longer transit travel times
East/west, north/south connections linking many communities	Few inter-community links
Short pedestrian walk times to transit	Longer pedestrian walk times to transit
Easy to understand	Difficult to understand

of residences or businesses. When walking distance increases or becomes more cumbersome, transit becomes a less attractive option. Complete Streets, with appropriate intersection spacing and pathway connections, minimize walking distance to transit and increase transit attractiveness.

Intersection spacing also affects how vehicular traffic is distributed. Well-distributed traffic means fewer lanes and an easier experience for pedestrians crossing roadways.

The following diagrams compare how road networks influence walkability in two different communities. Where the street layout is curvilinear or disconnected, people can only access about 30 per cent of the area within a five minute walk, compared to five-minute accessibility with a grid street pattern. If curvilinear design is required, then good pedestrian and transit-only links can overcome some of the shortcomings of this type of design.

Figure 3.4-4: Walkshed – grid street pattern

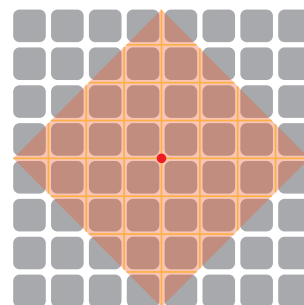
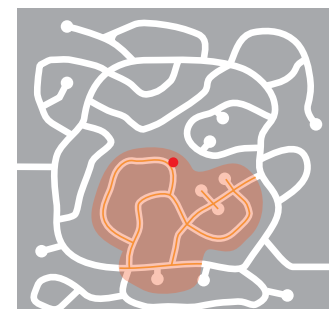

Figure 3.4-5: Walkshed – curvilinear street pattern



### 3. Consider Density and Load Balancing

Ideally, transit ridership is balanced along the length of a route. For this to occur, destinations and development must be evenly distributed along a route and generate trips in both directions. Complete Streets help attract destinations along a corridor and help contribute to attractive and efficient transit routes.

In many exclusively residential, suburban communities, bus routes will typically attract passengers travelling to and from their destinations during peak periods, with few passengers travelling in the opposite direction. This means transit vehicles are often full travelling in one direction and empty travelling in the other. This is not an effective use of transit resources.

Corridors that offer well-spaced mixed-land uses attract transit passengers and auto trips in all time periods and in both directions, thus reducing congestion along the network.

### 4. Plan for Future Development

Population growth forecasts indicate that 2.3 million people will live in Calgary in 60 years, which will dramatically impact transit service requirements.

In order to successfully manage transit service growth:

- Plan, develop and sequence growth areas so they are adjacent to, and act as extensions of, existing developed areas. This allows the expansion of transit services to be provided in small increments to serve new areas, as they develop and mature. Isolated developments are difficult to serve without a significant investment in transit service (i.e., a new route) that is often disproportionate to the number of people being served.
- Streets and pathways should be connected to existing streets and pathways in adjacent developments. Connecting residents and workers to adjacent areas is integral to building effective transit routes and using transit resources efficiently. Many communities in Calgary are only connected by one or two Skeletal Roads with no connection to adjacent communities. Each of these requires its own bus route, making effective and efficient transit connections impossible.

Figure 3.4-6: Density and land use patterns influence passenger loads and affect transit efficiency. Auto-oriented density patterns encourage one-way travel while transit-oriented density allows for bi-directional travel.

#### Auto-oriented Density

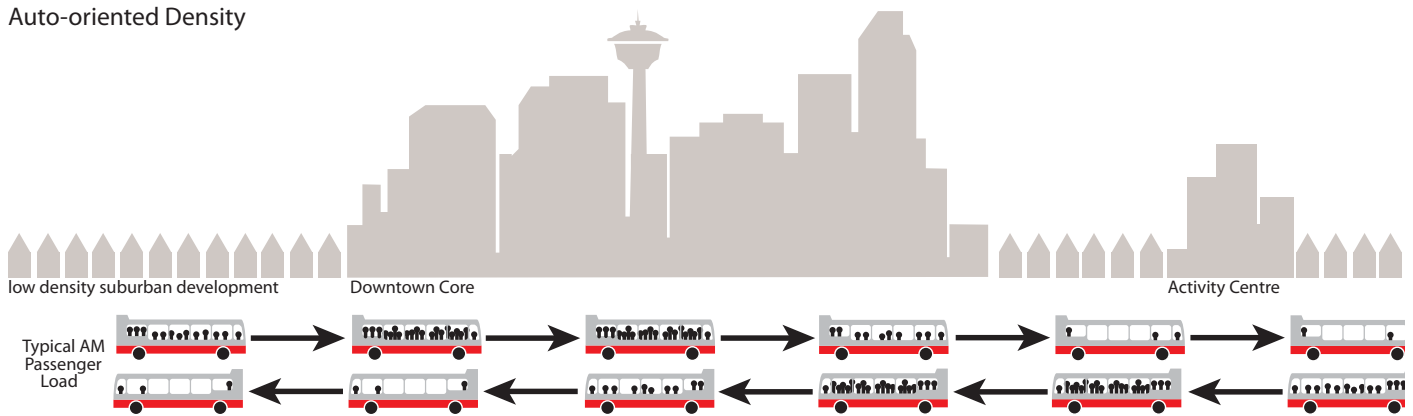

#### Transit-oriented Density

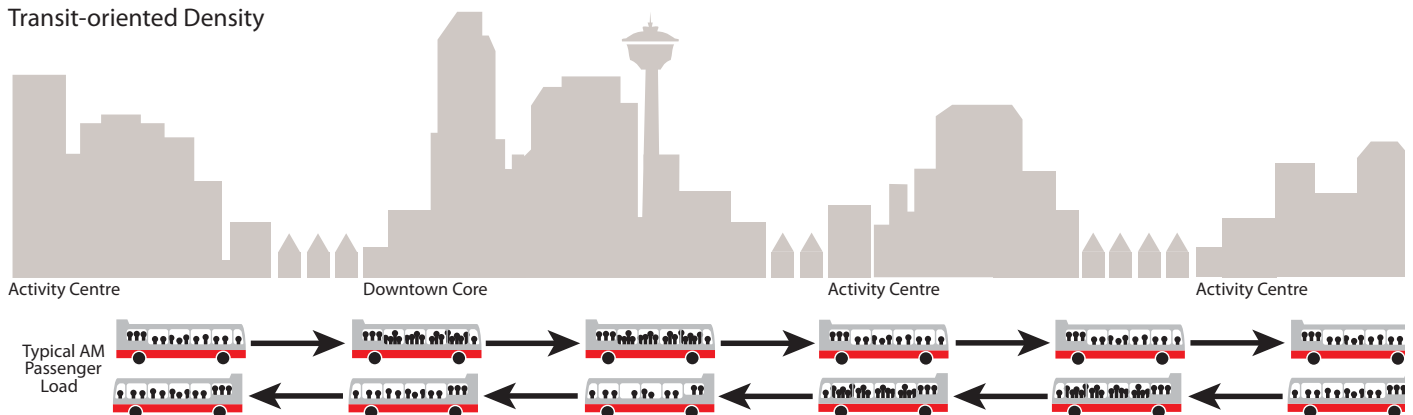

### 3.4.3 Transit Priority

Historically, street design has catered to autos and neglected active modes of transportation. Building Complete Streets that support active modes of travel should include consideration for transit priority where it is appropriate. In some locations it is preferable to advance the efficiency of transit while supporting the calming of other modes. This can be accomplished through transit priority measures.

Transit travel times and reliability improve when transit service is given priority over other vehicular traffic when required. Transit priority acknowledges the people-moving ability of transit services and is an important strategy for providing attractive transit service that is cost-effective to operate.

Transit priority should be implemented when:

- it will improve transit travel time and thus the attractiveness of transit service,
- there is a roadway or intersection along a transit route that is, or is projected to be congested.

There are a number of methods to provide transit priority, including:

#### 1. Bus-Only Lanes

Bus-only lanes can be implemented:

- on paved, widened shoulders along an expressway;
- full-time, or restricted to peak traffic periods;
- as reversible median lanes;
- as reserved lanes for high occupancy vehicles;
- through special signage and markings on existing curb lanes.

Figure 3.4-7: Bus-only lane: Crowchild Trail southbound at 26th Avenue S.W.



#### 2. Transit Priority at Intersections

Can be implemented as follows:

- Where it is desirable to let buses travel first through an intersection (queue jump).
- Signal priority, where approaching buses activate an extended green light or shortened red light.
- Bus-only lanes for turning or other through movements that other vehicles are not permitted to make.

Figure 3.4-8: Intersection priority: queue jump on 52nd Street at Marlborough Drive N.E.



#### 3. Other Forms of Priority

- Transit exemption signs: These signs allow through-moving or left-turning buses to do so from a right turning lane, allowing the bus to bypass the traffic queue.
- Bus only crossings: A bus only crossing is a transit-only connection between communities where the regular road network does not permit travel from one area to another, but allows buses and emergency vehicles. These connections provide additional connectivity for all active modes and supports a more attractive and efficient transit service.

Figure 3.4-9: Transit exemption sign: Whitehorn "Park and Ride", 36th Street N.E.



### 3.4.4 Transit Stop Design

Complete Streets allow space for attractive, safe transit stops. Transit stops are placed to maximize customer access, to allow transit vehicles to stop safely and to minimize interference with other vehicles.

Well-designed stops that are accessible to all users, comfortable in all seasons, and with designated waiting areas and passenger amenities (such as street furniture, shelters, and bike racks) can be instrumental in encouraging individuals to choose transit. These stops can also serve as focal points for place-making and community-building.

Transit stops that make a positive contribution to the streetscape should be functional, durable, graffiti-proof, and integrate seamlessly into the surrounding urban environment. Site and stop considerations are shown in Figures 3.4-10 and 3.4-11.

Figure 3.4-10: Transit stop design considerations

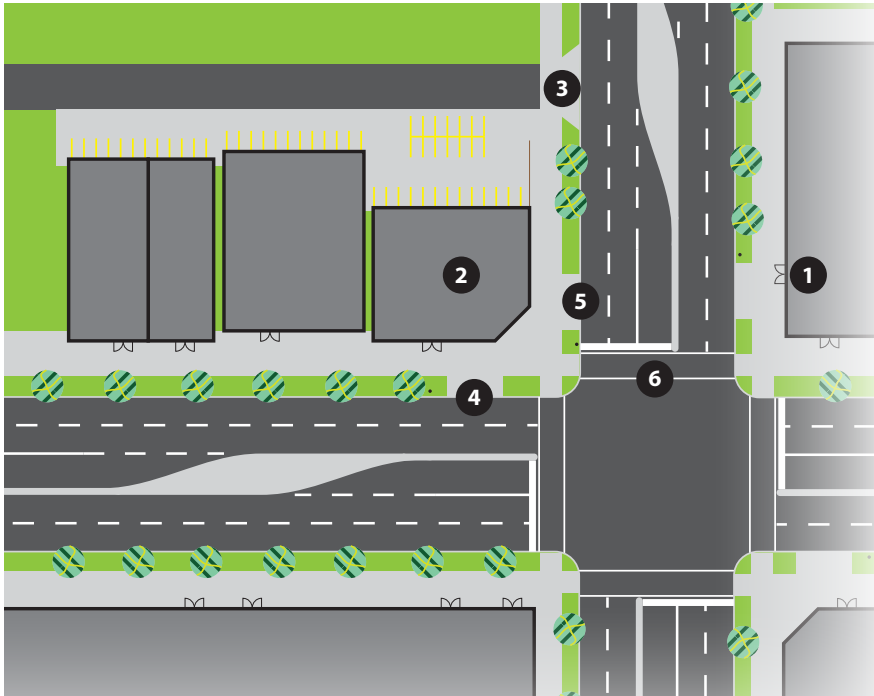

- 1 Orient building entrances towards the public realm.
- 2 Locate high density and mixed-use developments near transit corridors.
- 3 Ensure that vehicle access points are clear of bus zones to minimize conflicts.
- 4 Locate bus zones at safe and easy-to-understand locations near pedestrian crossings. Most commonly this is the far side of an intersection.
- 5 Consider alternate bus zones locations (such as nearside zones) where appropriate.
- 6 Ensure pedestrian connectivity.

Figure 3.4-11: Transit stop design considerations (continued)

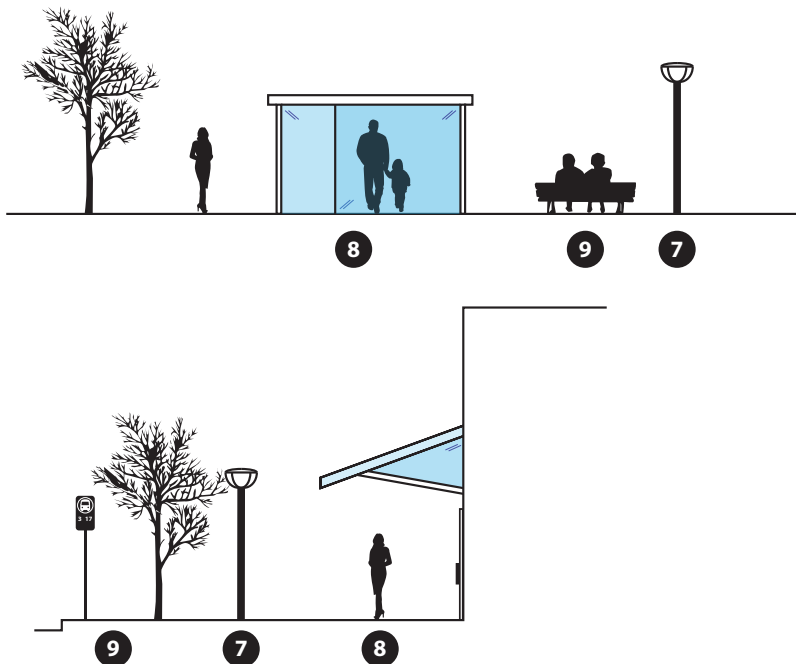

- 7 Ensure that there is adequate lighting for streets and pedestrians.
- 8 Provide protection from weather by incorporation overhangs into adjacent buildings or by providing stand alone bus shelters.
- 9 Ensure bus zones and amenities are built with consideration to the principles of Crime Prevention Through Environmental Design (CPTED).

### 1. Transit Stop Spacing

Transit stop spacing is guided by the type of transit service being offered and the land use along a corridor.

Stop spacing guidelines balance customer access needs with sufficient spacing to allow buses to travel at desirable operating speeds. Stops that are far apart are less attractive for customer access, while stops that are close together benefit customer access, but cause delays for passengers already travelling.

Stops spaced close together are appropriate for local service in communities where coverage is a priority. Stops spaced further apart are ideal for bus rapid transit service where speed is a priority.

### 2. Stop Spacing for New Developments

Bus stops are located at intersections where pedestrian facilities and connectivity are maximized. Keeping regular spacing between stops helps to make a transit service that is understandable and easy to navigate.

Figure 3.4-12: Where there are regularly spaced streets or pedestrian access to streets with bus routes, bus zones can be located at uniform intervals. This increases the customer access to the service and contributes to a high level of walkability.

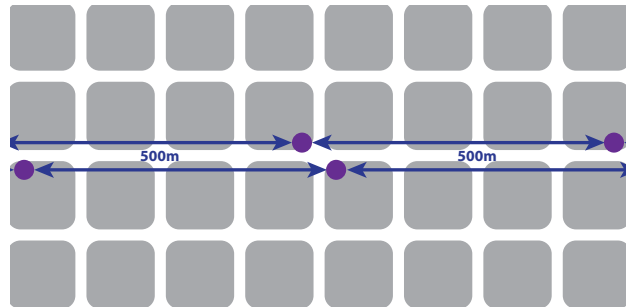
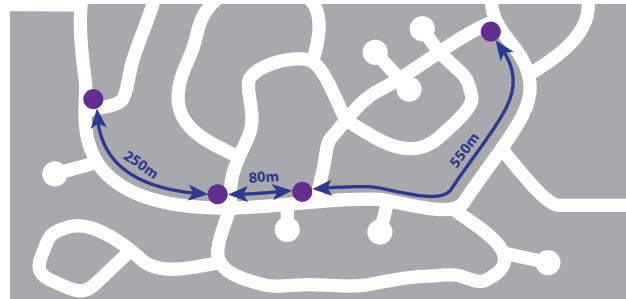

Figure 3.4-13: Irregularly spaced intersections and restricted pedestrian access leads to irregularly spaced bus zones. This can be difficult for customers to access the service and negatively impacts the walkability to and from transit service.



### 3. Stop Locations

There are three basic stop locations possible along roadways, in relation to intersections: nearside (before an intersection), farside (after an intersection) and mid-block (between intersections.)

Table 3.4-14: Typical bus zone locations

NEARSIDE		FARSIDE		MID-BLOCK	
Advantages	Disadvantages	Advantages	Disadvantages	Advantages	Disadvantages
<ul style="list-style-type: none"> <li>• For use where major destinations are near-sided.</li> <li>• To facilitate a queue jump.</li> </ul>	<ul style="list-style-type: none"> <li>• Creates conflicts with vehicles making right turns.</li> <li>• Buses may obscure traffic control devices and signals.</li> <li>• Encourages passengers to cross in front of the bus, so passengers are not easily seen by motorists in adjacent lanes.</li> </ul>	<ul style="list-style-type: none"> <li>• Minimizes turning conflicts with other vehicles.</li> <li>• Pedestrians cross behind buses, providing visibility for approaching traffic.</li> <li>• Traffic signals directly behind buses ensures opportunities for bus to merge back into traffic when signal changes.</li> <li>• Ideal where traffic signal priority (TSP) is implemented.</li> </ul>	<ul style="list-style-type: none"> <li>• Buses may have to stop twice: once for a traffic control device or signal, and again to access the bus zone.</li> </ul>	<ul style="list-style-type: none"> <li>• Minimizes turning conflicts with other vehicles.</li> <li>• Required if there are long distances between intersections.</li> <li>• Located at key pedestrian facilities.</li> </ul>	<ul style="list-style-type: none"> <li>• Zones require more curbside space for bus approach and merge (decreased space for parking).</li> <li>• Increases transfer distances for customers.</li> <li>• May encourage jaywalking.</li> </ul>

Because they are the safest option, farside stops are preferred in all areas.

Mid-block bus stops are avoided due to the lack of pedestrian facilities between intersections. They can encourage jaywalking and should be used only where there is excessively long intersection spacing.

Other factors must also be considered:

- Requirement for transit priority – farside bus stops are required for transit signal priority while nearside stops are required for queue jumps.

- Proximity and access to destinations (linking decisions to land use).
- Traffic volume, including high turning movements, may influence where a transit stop is located.
- Site constraints (e.g., driveway placement) can influence the length of curbside space available for a stop.



**4. Curbside Stops, Lay-Bys and Curb Bulbs**

Curb design at transit stops can be varied depending on the street design context. Curb extensions and bus bays (lay-bys) are appropriate alternatives to the standard curbside stop. For example, a bus bay is suitable to minimize traffic delay on an arterial road when a bus is

stopped for extended periods, while a curb bulb would be appropriate to prioritize transit use and pedestrian environment for Liveable or Local Streets. Figure 3.4-15 illustrates three types of curbside design at transit stops. All three typologies are used in Calgary.

Table 3.4-15: Typical bus zone types

CURBSIDE		LAY-BY		CURB BULB	
Advantages	Disadvantages	Advantages	Disadvantages	Advantages	Disadvantages
<ul style="list-style-type: none"> <li>• Easy access for buses.</li> <li>• Avoids delays associated with merging back into traffic.</li> <li>• Low infrastructure costs.</li> </ul>	<ul style="list-style-type: none"> <li>• Can disrupt traffic if buses stop for too long.</li> </ul>	<ul style="list-style-type: none"> <li>• Used where posted speed limit is greater than 60 km/h or at major scheduled time points.</li> <li>• Protects pedestrians and passengers from traffic.</li> <li>• Removes stationary buses from traffic lanes.</li> <li>• Can be integrated into queue jumps.</li> </ul>	<ul style="list-style-type: none"> <li>• Difficult for buses to merge into traffic.</li> <li>• Decreases operating efficiency.</li> <li>• Higher infrastructure and land costs.</li> <li>• May reduce passenger waiting area.</li> </ul>	<ul style="list-style-type: none"> <li>• Minimizes delays (buses do not have to merge back into traffic).</li> <li>• Creates a larger passenger waiting area.</li> <li>• Shortens pedestrian crossing distance of intersection.</li> </ul>	<ul style="list-style-type: none"> <li>• Can disrupt traffic if buses stop for too long.</li> <li>• Higher infrastructure costs if retrofitted.</li> </ul>

**3.4.5 Conclusion**

The design of the roadway network and specific street design principles can have a significant impact on the ability of transit service to be provided in an attractive and efficient manner. Pedestrian connectivity to transit stops and the ability for transit to provide efficient and effective connections and access to destinations are important criteria for achieving Complete Street environments.

**3.4.6 Checklist**

When constructing, retrofitting or planning Complete Streets/communities, the following transit-related questions should be asked:

- Is the road network direct and easy to understand?
- Can buses travel easily and directly between communities?
- Are the streets and connecting neighbourhoods walkable?
- Are additional pedestrian connections located where there is reduced pedestrian access?
- Is density planned for a location supported by the transportation network?
- Are connecting streets spaced in a regular and easy-to-understand pattern?
- Will the public realm space of the Complete Street support quality bus zones?

# Chapter 3

## 3.5 Traffic Calming Design

### 3.5 TRAFFIC CALMING DESIGN

---

#### 3.5.1 Purpose

The Institute of Transportation Engineers (ITE) defines traffic calming as:

***“...the combination of mainly physical measures that reduce the negative effects of motor vehicle use, alter driver behaviour and improve conditions for non-motorized street users.”***

The phrase, ***“the combination of mainly physical measures,”*** means physical measures plus a supportive policy environment such that traffic calming is permitted and encouraged.

***“Reduce the negative effects of motor vehicle use”*** means changing the role and design of streets to accommodate motorists in ways that reduce the negative social and environmental effects on individuals, neighbourhoods, districts, retail areas, corridors, downtowns, and society in general (e.g., reduced speeds, reduced sense of intrusion/dominance, reduced energy consumption and pollution, reduced sprawl, and reduced automobile dependence).

***“Alter driver behaviour”*** means that the street design helps drivers self-enforce lower speeds, resulting in less aggressive driving and increased respect for non-motorized users of the streets.

***“Improve conditions for non-motorized street users”*** means promoting walking and cycling, changing expectations of all street users to support equitable use of the street, increasing safety and comfort (i.e., the feeling of safety), improving the aesthetics of the street, and supporting the context of the street.

The definition of traffic calming is broad enough to apply to myriad contexts and situations but specific enough to have independent meaning so that it is not confused with other street design elements and design approaches.

Through design, traffic calming aims to slow the speeds of motorists to the “desired speed” (usually 30 km/h or less for residential streets and 40 to 50 km/h for collector streets) in a context-sensitive manner by working with the stakeholders (i.e., residents, business owners, and agencies). Traffic calming is acceptable on all street types where pedestrians are allowed. Traffic calming is applicable to all sizes of towns and cities as well as rural villages and hamlets.

Traffic calming typically connotes a street or group of streets that employ traffic calming measures with a “self-enforcing” quality that physically encourages motorists to drive at the desired speed. When a group of streets are involved, it is normally referred to as “area-wide calming.” Traffic calming measures can also be designed to treat and manage streetwater.

Figure 3.5-1 : Curb extension with rain garden



Typically, traffic calming measures are often conceived, designed and implemented retroactively to mitigate the negative impacts of traffic in neighbourhoods after the build-out stage. Traffic calming strategies should continue consider emergency and transit routes when considering the appropriate measures that can be used. Complete Streets guidelines dictate that traffic calming measures should be incorporated into the initial design of community road networks.

A neighbourhood street or group of streets that has had traffic calming measures incorporated provides a safer and more comfortable environment for all road users. Traffic calming measures should never negatively impact pedestrians or cyclists in concept, design or installation. While streetscape and landscape are not necessarily an integral part of traffic calming, these improvements are congruent with the principles of traffic calming, and frequently enhance their impact.

### 3.5.2 Traffic Calming Policy (TP-002)

Traffic calming is an effective approach to address existing traffic issues on Local Streets (Residential and Collector Streets). The City of Calgary’s Traffic Calming Policy provides direction on the types of traffic calming measures to consider in Calgary, and appropriate circumstances for their use.

The main objectives of the Policy are to:

- reduce vehicle speed;
- discourage through traffic on Local Streets; and
- minimize conflicts between street users.

The main principles of the Policy are to:

- involve the community;
- identify the problem (not the symptom);
- quantify the problem;
- consider improvements to the major street network first;
- use self-enforcing measures;
- minimize access restrictions; and
- target automobiles and non-local trucks only.

There are four categories of traffic calming measures:

- Vertical deflection (e.g., speed humps)
- Horizontal deflection (e.g., traffic circles)
- Obstructions (e.g., closures)
- Signage (e.g., turn prohibitions)

Table 3.5-2 from the Canadian Guide to Neighbourhood Traffic Calming (TAC ITE 1998) provides a listing of the more common traffic calming measures for Canada and their relative benefits when applied to neighbourhood streets.

Table 3.5-2: Traffic calming measures – potential benefits

CALGARY TRAFFIC CALMING MEASURES – POTENTIAL BENEFITS					
MEASURE		Speed reduction	Volume reduction	Conflict reduction	Environment
Vertical deflection	Raised crosswalk	●	○	●	●
	Raised intersection	●	○	●	●
	Rumble strip	○	○	○	○
	Sidewalk extension	●	○	●	○
	Speed hump	●	●	●	●
	Textured crosswalk	○	○	●	●
Horizontal deflection	Chicane, one-lane	●	●	●	●
	Chicane, two-lane	●	○	●	●
	Curb extension	●	○	○	●
	Corner radius reduction	●	○	○	●
	On-street parking	●	○	○	●
	Raised median island	●	○	●	○
	Traffic circle	●	●	●	●
Obstruction	Direction closure	○	●	●	●
	Diverter	○	●	●	●
	Full closure	○	●	●	●
	Intersection channelization	○	●	●	●
	Raised median through intersection	○	●	●	●
	Right-in/right-out island	○	●	●	●
Signing*	Maximum speed	●	○	○	○
	Right/left turn prohibited	○	●	●	●
	One-way	○	●	●	●
	Stop	○	●	●	○
	Through traffic prohibited	○	●	●	●
	Traffic-calmed neighbourhood	○	○	○	●
	Yield	○	○	●	○

\*The primary purpose of signing is to regulate traffic movements, not to calm traffic.

- Substantial benefits
- Minor benefits
- No benefit

The City of Calgary Traffic Calming Policy supplements the “Canadian Guide to Neighbourhood Traffic Calming.” Table 3.5-3 describes the approved traffic calming policy measures and the appropriate street classifications for their application.

Table 3.5-3: Calgary traffic calming policy measures

CALGARY TRAFFIC CALMING POLICY MEASURES						
MEASURE	FIGURE	Residential	Collector	Primary Collector	Arterial	
		< 2,000 vpd	2,000-8,000 vpd	8,000-15,000 vpd	> 15,000 vpd	
Vertical deflection	Raised crosswalk	3.5-4	●	●	○	○
	Raised intersection		○	○	○	○
	Rumble strip		○	○	○	○
	Sidewalk extension		●	○	○	○
	Speed hump	3.5-5	●	●	○	○
	Textured crosswalk		○	○	○	○
	Speed table	3.5-6	●	●	○	○
	Speed cushion	3.5-7	●	●	○	○
Horizontal deflection	Chicane, one-lane	3.5-8	●	○	○	○
	Chicane, two-lane		○	○	○	○
	Curb extension	3.5-9	●	●	●	●
	Corner radius reduction		●	●	●	●
	On-street parking		●	●	●	○
	Raised median island	3.5-10	●	●	●	●
	Traffic circle	3.5-11	●	●	○	○
Obstruction	Direction closure	3.5-12	●	●	○	○
	Diverter	3.5-13	●	●	○	○
	Full closure		○	○	○	○
	Intersection channelization		●	●	●	●
	Raised median through intersection	3.5-14	●	●	○	○
	Right-in/right-out island	3.5-15	●	●	○	○
Signing*	Maximum speed		○	○	○	○
	Right/left turn prohibited		○	○	○	○
	One way		○	○	○	○
	Stop		○	○	○	○
	Through traffic prohibited		○	○	○	○
	Traffic-calmed neighbourhood		●	●	○	○
	Yield		○	○	○	○

\*The primary purpose of signing is to regulate traffic movements, not to calm traffic.

- Appropriate measures
- Use with caution
- Not recommended

Commonly used traffic calming measures in Calgary (referenced in Table 3.5-3) are demonstrated in the following figures:

Figure 3.5-4: Raised crosswalk



Figure 3.5-5: Speed hump



Figure 3.5-6: Speed table



Figure 3.5-7: Speed cushion



Figure 3.5-8: Chicane one-lane



Figure 3.5-9: Curb extension



Figure 3.5-10: Raised median island



Figure 3.5-11: Traffic circle





Figure 3.5-12: Direction closure



Figure 3.5-14: Raised median through Intersection



Figure 3.5-13: Diverter



Figure 3.5-15: Right-in/right-out island



# Chapter 3

## 3.6 Streetscape Design

### 3.6 STREETScape DESIGN

---

#### 3.6.1 Green Infrastructure and Low Impact Development

##### INTRODUCTION

The goal of the Calgary Transportation Plan (CTP) and Municipal Development Plan (MDP) is to develop a sustainable city by protecting the natural environment, ensuring the economy remains strong, with communities that are vibrant and accommodating. The CTP includes transportation policies that work in conjunction with the land use policies of the MDP. Complete Streets is one of the CTP policy areas identified, which includes the specific inclusion of Green Infrastructure (GI) policies. GI is defined in the MDP/CTP as:

*An interconnected network of natural green and engineered green elements applicable at multiple scales in the land use and mobility framework. Natural green elements include the conservation and integration of traditional green elements such as trees, wetlands, riparian areas and parks. Engineered green elements include systems and technologies designed to mimic ecological functions or to reduce impacts on ecological systems. Examples include green alleys, green buildings and green roadways and bridges.*

Another policy area identified in the CTP is Environment and Transportation. The objective of this policy is to protect air, land, water and biodiversity in the planning, design, operation and maintenance of all transportation infrastructures. GI supports this objective.

GI can be integrated with another city initiative related to Low Impact Development (LID). LID is defined in the MDP/CTP as:

*An approach to land development that uses various land planning and design practices and technologies to simultaneously conserve and protect natural resource systems and reduce infrastructure costs.*

LID is being advanced by The City of Calgary Water Resources Business Unit, and includes sustainable stormwater source control practices (SCPs).

The City of Calgary is currently developing the Low Impact Development Technical Guidance Manual for the development industry and City Administration to aid in the design and approval of LID facilities. The manual will include design, construction specification, plus maintenance and operation guidance.

## STRATEGIC GOALS

Progress in meeting the goals and objectives in the MDP/CTP will be monitored by measuring core indicators for land use and mobility. These high level indicators include:

- watershed health as measured by per cent of impervious surface, and
- urban forest as measured by per cent of tree canopy.

To assist in moving these goals and objectives forward, GI Policies included in Section 3.7 of the CTP stipulate:

- All new and retrofit road and street designs should incorporate GI strategies to contribute to the environmental health and visual aesthetics of the urban fabric.
- In all designs, natural processes should be maintained and re-established by conserving, protecting, and restoring habitat quantity and quality. Watersheds should be protected by filtering roadway runoff.
- Native vegetation and a layered tree canopy should be incorporated within corridors to reduce the urban heat island effect and improve air quality.

The GI and LID applications summarized in the next section fully support these policies.

When evaluating GI or LID solutions to introduce in mobility corridors, all functional elements that are either required or desired within the limits of the ROW must be considered.

Figure 1-3, Section 1.4 identifies three specific corridor zones:

- roadway (space between the curb lines),
- public realm, and (space between the curb line and the property line)
- interface zone (space between the property line and developed areas and buildings on private lands).

Applications to introduce sustainability strategies and solutions will vary by zone.

## GREEN INFRASTRUCTURE STRATEGIES

The following strategies provide a framework and guidance for development and implementation of more detailed, sustainable solutions. Specific solutions will be supported by guidelines and standards from various functional departments within The City.

### 1. Water – Mimic Natural Hydrology (Figure 3.6-1)

- Maximize on-site infiltration and moisture retention (through vegetated swales, absorbent landscape, infiltration planters and galleries, rain gardens and soil cells);
- Reduce effective impervious area (with narrow paved areas, permeable pavements);

- Slow and detain runoff (with flow-through planters, rain gardens, trees the urban forest and soil cells).
- Filter street runoff (with filter strips, vegetated swales, rain gardens, permeable pavements, stormwater wetlands and soil cells);
- Minimize potable water demand (through efficient water use (WaterWise landscape)).

### 2. Habitat – Enhance Urban Forestry (Figure 3.6-2)

- Preserve and enhance biodiversity (through diverse native vegetation, recreating wetland areas, and creating a layered canopy);
- Increase habitat connectivity (through wildlife corridors, crossings and passages), and
- Increase urban tree health and canopy (with mature trees).

### 3. Air – Mitigate Climate Change (Figure 3.6-2)

- Design networks and streets to prioritize walking and cycling;
- Enhance the Urban Forest (through maximum tree planting and optimum growth conditions for trees), and
- Reduce energy demand (with energy conservation and alternative energy systems).

## GREEN INFRASTRUCTURE IMPLEMENTATION STRATEGIES

- Designate space to introduce GI as feasible;
- Use sustainable techniques and technologies to reduce environmental impacts;
- Maintain and re-establish natural processes by conserving, protecting and restoring habitat quantity and quality;
- Ensure that subgrade soil moisture content is not increased in the implementation of GI adjacent to high-volume streets;
- Consider the following elements when building GI into mobility corridors: site assessment, streetscape, pavement, utilities, stormwater management, landscape and construction practices;
- Integrate strategies and solutions that provide the greatest environmental benefits into the corridor, and
- Apply GI whenever transportation corridors are planned, constructed, repaired or maintained. (Not every strategy will be applicable in these corridors, but as many elements as possible should be included).

Figure 3.6-1: Mimic natural hydrology

# GREEN INFRASTRUCTURE STRATEGIES

Mimic Natural Hydrology

## Maximize Infiltration

Infiltration Galleries



University Infiltration Gallery

Curb Cuts



Water Centre

Rain Gardens: Marlowe Place NE



Marlowe Place NE

## Detain Stormwater

Structured Swales



Pennoyer Street, Portland

Flow-through Planters



12 Street, Portland

Permeable



UBC Finance Parking Lot

Curb Extensions



4 Street SW

## Minimize Impermeable Surfaces

Permeable Pavement



Permeable Pavers



Currie Barracks Test Site

Grass Paving



## Filter Runoff

Vegetated Swales



Currie Barracks Test Site

Filter Strips



Mission Road

Stormwater Wetlands



UniverCity Ponds



Figure 3.6-2: Habitat – enhance urban forestry

Enhance Urban Forestry

### Create Habitable Patches

**Native Vegetation**



Roxboro Park

**Layered Canopy**



Lansdowne Avenue SW

**Diverse Vegetation**



Lansdowne Avenue SW

**Vegetated Medians and Islands**



1 Avenue NE, Bridgeland

### Create Connectivity

**Green Corridors**



Bow Pathway, Westhillhurst

**Wildlife Crossings**



Elbow Pathway, Mission

**Wildlife Crossings**



Banff National Park

### Expand Areas of Urban Forest

**Planted Islands**



Mission Road

**Planter Boxes**



Memorial Drive

### Create Optimum Growth Conditions

**Tree Trenches**



4 Street SW

**Soil Cells**



2 Avenue NW

Mitigate Climate Change

### Intercept Precipitation

**Water Absorbing Vegetation**



Currie Barracks Test Site

**Trees in Paved Areas**



Macleod Trail SE

### Preserve Mature Trees



Garden Crescent SW

### Reduce Urban Heat Island Effect

**Increase Tree Canopy**



8 Street NW

**High Albedo Pavement**

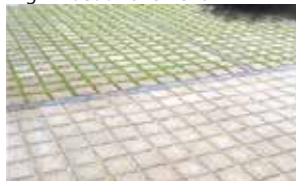

### Reduce Irrigation

**WaterWise Landscape**



Willow Park Drive

### Reduce Energy Use

**Solar Powered Irrigation**



75R Crowfoot Cir NW

**Energy Efficient Lighting**



Mission Road



## **LOW IMPACT DEVELOPMENT TECHNICAL GUIDANCE**

In support of The City of Calgary's Stormwater Strategy to Ensure Resources Conservation, and to meet pollution prevention mandates, The City has adopted several methods to manage stormwater runoff. Reducing the amount of impervious cover, increasing the amount of natural lands set aside for conservation, and using pervious areas for more effective stormwater treatment should be considered during planning at the watershed scale.

The City of Calgary is currently developing the Low Impact Development Technical Guidance Manual for the development industry and City administrators. The manual will include design guidelines, design specifications and checklists for six LID practices. The manual will include design, construction specifications, plus maintenance and operation guidance for the following topics:

1. Geotechnical and hydro geological consideration
2. Vegetative and absorptive practices:
  - a. vegetated swales
  - b. rain garden
  - c. absorbent landscaping
  - d. soil cells
3. Green roof systems
4. Stormwater capture and re-use
5. Rainwater harvesting
6. Permeable pavement structures

SCPs that can be installed within the street or utility ROW are Module 2 and Module 6. Module 1 provides guidance on geotechnical and hydrogeological investigation required for the installation of SCPs. For more information on LID practices and design specifications, visit [www.calgary.ca](http://www.calgary.ca) or call 311."

## **LOW IMPACT DEVELOPMENT STRATEGIES**

The following provides a brief description of suitable stormwater source control practices (SCPs) contained in the Modules that apply within road ROWs:

### **Module 1 – Geotechnical Requirements**

Several types of SCPs rely on infiltration to effectively manage water from storm (and/or snowmelt) events. This module will provide details of the geotechnical and hydrogeological investigations and computations required for site assessment, where infiltration SCPs will be used. It will also identify the procedures required to ensure that established soil conductivities are maintained during construction, and for the design life of the chosen SCP.

## Module 2 – Vegetative and Absorptive Practices

This module will describe in detail key design and construction principles and criteria for properly designing these vegetative SCPs. A brief description of the purpose of each practice is listed below.

### Vegetated Swales

Treat and reduce the runoff volume from minor storm events, and carry excess runoff from major storm events downstream.

Figure 3.6-3: Vegetated Swales



### Rain Gardens

Facilitate reduction of runoff flow and treatment of stormwater through settling, filtration, extended detention, infiltration and biological uptake.

Figure 3.6-4: Rain Garden



### Absorbent Landscaping

Reduce stormwater runoff and preserve/restore the moisture storage and infiltration capacities of soils by increasing the depth of topsoil in landscaped areas.

Figure 3.6-5: Absorbent landscaping

### ABSORBENT LANDSCAPE



1. CROWN INTERCEPTION

2. THROUGHFALL AND STEMFLOW

3. EVAPOTRANSPIRATION

4. SOIL WATER STORAGE

5. SOIL INFILTRATION

6. SURFACE VEGETATION

7. ORGANICS AND COMPOST

8. SOIL LIFE

9. INTERFLOW

10. DEEP GROUNDWATER

11. WATER QUALITY IMPROVEMENT

12. IMPERMEABLE SURFACES AND  
SURFACE RUNOFF

### Soil Cell Technologies

Facilitate reduction of runoff flow and treatment of stormwater through fine filtration, extended detention, infiltration and biological uptake. These systems provide structural support for overlying hard surfaces, thereby providing support for larger volumes of uncompacted soils, which promotes tree and vegetation health and larger canopies.

Figure 3.6-6: Soil Cell



### Module 6 – Permeable Pavement

This module will describe, in detail, key design features for a variety of pavement types. It will also provide design and construction criteria that will enable designers to properly design permeable pavement structures. Figure 3.6-7 shows a typical permeable pavement cross-section. Permeable pavement facilitates infiltration of precipitation falling directly on the porous surface or flowing from adjacent areas, and can be installed in low-speed and low-volume traffic areas accommodating pedestrian or vehicle traffic.

Figure 3.6-7: Typical permeable pavement details (Smith 2009)

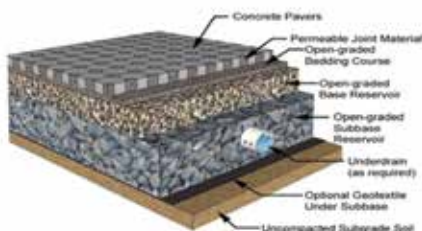

### 3.6.2 Urban Forestry

Trees are a valuable part of our communities. Trees clean the air, conserve energy, provide wildlife habitat, and reduce the “heat island” effect. Not only are they beautiful, but also they provide privacy and security, and add a sense of serenity and character to our surroundings. Trees are the first line of defence in reducing flooding and erosion during storm events. Their canopies slow down and clean storm water runoff. Well maintained and healthy street trees can increase sales in commercial areas. Properly spaced trees can also have traffic calming effects in residential neighbourhoods. Shaded streets are not only more walkable but the life of the asphalt is extended decreasing maintenance and lifecycle costs.

#### PARKS URBAN FOREST STRATEGIC PLAN

In 2007, The City of Calgary Council approved the Parks Urban Forest Strategic Plan. The Plan provides a vision and the framework for City staff and community partners to make key decisions about the management of the urban forest. This will ensure sustainability today that will have a positive impact for future generations.

The Plan includes 15 guiding principles that provide the context for the outcome-based policies, strategies, and key action steps. Addressing these principles and achieving our outcomes is organized into three (3) focus areas:

1. Achieve and maintain healthy trees.
2. Collaborate with the community.
3. Resources to manage and measure the asset.

The Plan has specific strategies that support the Complete Streets Guide such as 6.4: Promote Trees as Tools to Retain Customers in Commercial Districts and 14.1: Invest in Green Infrastructure.

The complete Plan can be downloaded at [www.calgary.ca](http://www.calgary.ca) (search “Urban Forestry Strategic Plan”).

#### GROWING SUSTAINABLE TREES & A HEALTHY URBAN FOREST

To achieve and maintain a healthy urban forest, it is critical that trees are planted in appropriate locations using sustainable planting techniques. They then must be cared for and maintained. Trees require our help to reach a size where they can provide valuable environmental, economic, social, and benefits to our community. The following are a few key factors to consider:

##### Preserve Existing Trees

The first step to ensure that the urban forest is growing is to preserve the existing trees we have. It takes many years for trees to grow and become established but only minutes for them to be removed. Early during the planning phase consideration should be given to preserve mature and healthy trees. Adjusting alignments, sidewalks and

Figure 3.6-8: Ratio of tree size to volume. (Source James Urban)

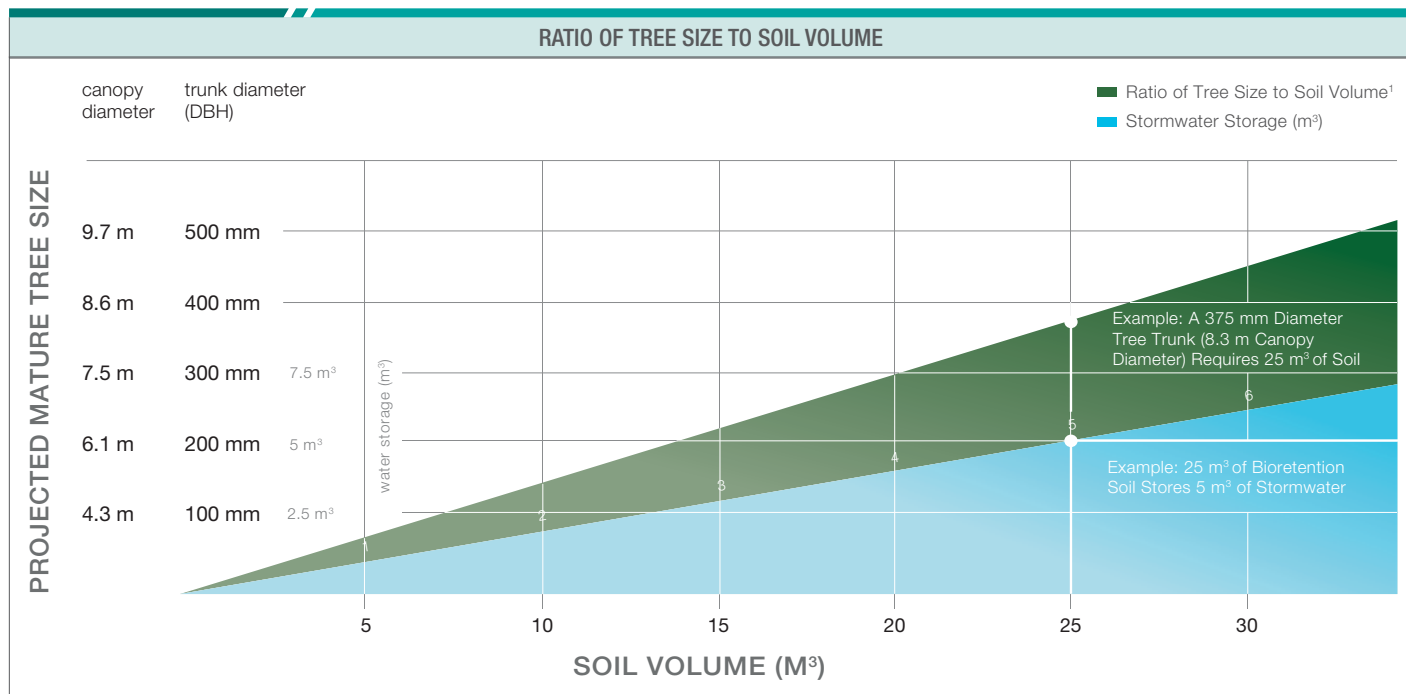

utilities could have a significant impact on mature trees in established communities. Tree preservation techniques such as boring utilities or “bridging” sidewalks over tree roots should also be considered. The City has two bylaws that pertain to protecting and preserving public trees. A tree protection plan is required if construction activities are within six (6) meters of a public tree.

**Provide Adequate Soil Volume**

A tree’s ability to grow and be healthy is directly related to the amount soil that is available to its roots. Trees with limited soil rarely grow to their mature size, and provide the many benefits they are intended to when planted. During the development of the Residential Street Design Policy, research indicated that in order to ensure a large size tree species reaches a 50-year life span, it requires a minimum soil volume of 30 cubic metres. The growing area must be permeable, open to the air, and free of utilities to a 1.0 m depth. This standard applies to all street classifications. Medium-size tree species require a minimum of 20 cubic metres of soil volume, and small-size tree species require a minimum of 10 cubic metres of soil volume. With Parks approval, soil volume can be shared between trees, and soil volume requirements reduced if techniques are applied that improve growing conditions.

**Provide Adequate Soil Quality**

Not only is the amount of soil important the soil should be of good quality and uncompacted so that the tree roots can grow and absorb water and nutrients. Trees in urban areas are often planted into poor soil that is compacted

so that water and air cannot exchange and lacks nutrients. Using best management planting techniques such as digging a planting area a minimum 2-3 times the width of the root ball helps the tree roots to get established along with a mix of new and existing soils.

**Provide Appropriate Space Above and Below Ground**

Trees must have room both above and below ground to reach their mature tree size. If trees are planted too close to buildings or other features their canopies must be pruned as to not to conflict reducing potential for canopy cover. Also, below ground utilities such as power, cable or water must be located far enough away from the root system of the tree that they do not conflict. Tree roots may be damaged or destroyed when repairs are needed to be made. Alternatively, the installation of a root barrier or geo membrane could be considered to protect roots from utilities.

**Provide Watering and Care**

Calgary’s climate in particular is trying for vegetation due to drying winds and drought cycles. Trees require supplemental watering during their first 1-5 years after planting until they are established. Newly planted trees should be on a scheduled cycle that waters deeply and infrequently to mimic nature. Also, trees require ongoing care in their early life. They should be “structured” pruned which will provide the tree strong form, reducing storm damage and associated maintenance costs. Tree should also be monitored for pests and diseases.



**SUGGESTIONS ON HOW TO ACHIEVE SOIL VOLUMES**

**Street Tree Trench Suspended Sidewalk**

Is an engineered suspended sidewalk designed so that street trees are connected, continuous and have access to soil located under the concrete.

Tree trench during construction



The City of Calgary specifications for a tree trench is shown in Figure 3.6-9.

Figure 3.6-9: Tree trench specifications

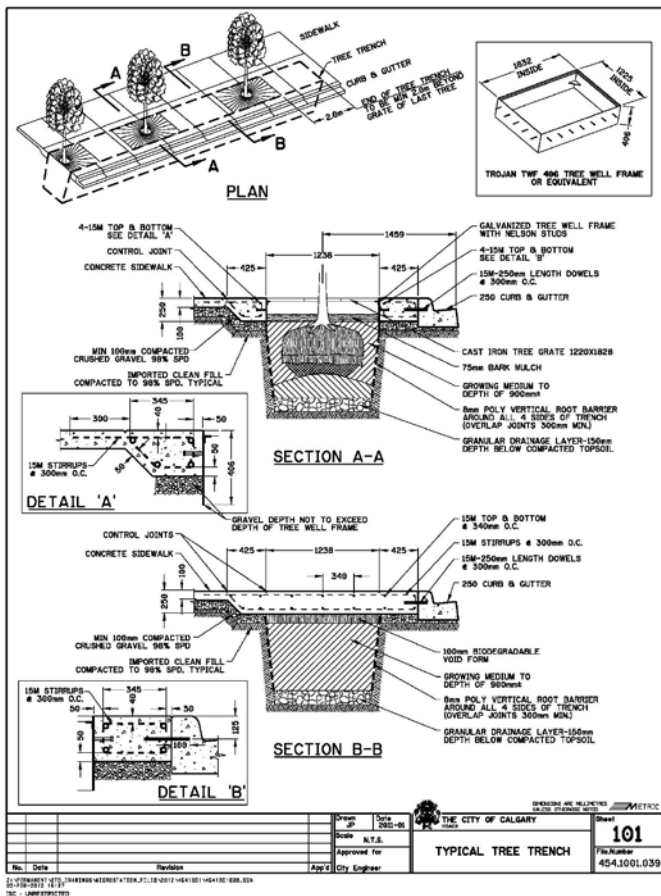

**TREE PLANTING GUIDELINES**

General guidelines for planting public trees in Calgary are:

1. Locate away from curbs to protect from salt spray (2.0 m minimum).
2. Locate trees a minimum 1.0 m from sidewalks and shallow utility easements.
3. Use raised planter beds (particularly in narrow medians). Ensure that safety standards (e.g., clearances) are met.
4. Where wider boulevard median space is available, consider offset double-row planting.
5. For higher traffic volume locations, consider application of wood mulch to better protect trees from salt spray (e.g., Canyon Meadows Drive S.E.).
6. For redevelopment projects where new roads are being relocated in established areas, alignments should consider the protection of mature public trees.
7. Particularly in constrained boulevard spaces, use Silva-cell installation, which allows structural support and uncompacted soil to coexist.
8. Minimum soil volumes for trees: 30 m<sup>3</sup> for large species, 20 m<sup>3</sup> for medium species, and 10 m<sup>3</sup> for small species.
9. Tree species variety is strongly encouraged.

## SOIL CELLS

Soil cells are plastic stacking structure systems that can be filled with soil and suspended pavement above. This increase in soil volume not only supports large tree growth but some systems can be designed to provide a stormwater management component.

Silva cells (Courtesy of Deep Root Partners, LP)



11 Avenue SW ENMAX Utility Line



2 Avenue Streetscape Improvements



### 3.6.3 Shallow Utility Design

The aerial and buried utility elements are intricate components of the roadway cross-section. In many cases, the required location and clearances associated with these elements drives the design of the other cross-section elements. Reserved space within the public realm (or boulevard) is required for installation, access for maintenance, and clearance from other buried elements.

These are the guidelines (and policies) for shallow utility placement:

1. All utilities should be located so that manholes and other protruding fixtures are away from wheel paths, curbs, gutters and the travel surfaces of pedestrians and cyclists.
2. CTP Policy 3.7s: The priority and placement of shallow utility infrastructure (trenches and above-ground equipment) is as follows:
  - i. in rear alleys and lanes;
  - ii. in shallow utility easements on private property;
  - iii. within ROW, placed in the public realm zone; and
  - iv. within ROW under the roadway (e.g., parking, bike lanes, or paved shoulders).
3. CTP Policy 3.7t: Deep utilities should be located so that manholes and appurtenances do not interfere with the movement of pedestrians, cyclists, and vehicles.
4. Cross-sections showing placement of shallow utilities and easements must be provided at the Outline Plan and Land Use stages for all street classifications.
5. In higher density areas and Liveable Street corridors, shallow utilities should be placed underground in joint trenches wherever possible. Easement may not be required if sufficient boulevard width is available to accommodate shallow utilities.
6. Common trenching and utility ducts for shallow utility lines should continue to be utilized to minimize line assignments as much as possible. In the event that common trenching is not possible, separate alignments for electric, communications, and streetlight cable, and gas lines should be identified. The required separation from the sidewalks, trees, streetlight poles, hydrants and service valves must be respected. Refer to the latest City of Calgary Design Guide for Subdivision Servicing.

7. The placement of shallow utility above-ground equipment, transformers and pedestals, and their required separation from the sidewalks, trees, streetlight poles, hydrants and service valves must be respected. Refer to the latest City of Calgary Design Guide for Subdivision Servicing. Above-ground equipment cannot be placed in sidewalks or multi-use pathways. Where above-ground equipment cannot be accommodated within the public realm zone, pocket easements or other space outside the ROW is required.
8. Where shallow utility lines remain within the roadway zone without adequate unpaved space, site specific planning and design must be completed to accommodate the installed shallow utility infrastructure.
9. Where utilities are installed overhead, separate alignments should be shown for the electric power poles. Utility poles should not be utilized for street lighting.
10. Where public street trees, low impact development features, and/or other public realm features are desired but space is not available, consider Silva-cell installation, which will allow these elements to coexist with shallow utilities.
11. Front yard shallow utility easements for joint services along residential fronting residential and collector streets shall be no greater than 2.4 m.

Figure 3.6-10: Shallow utility locations

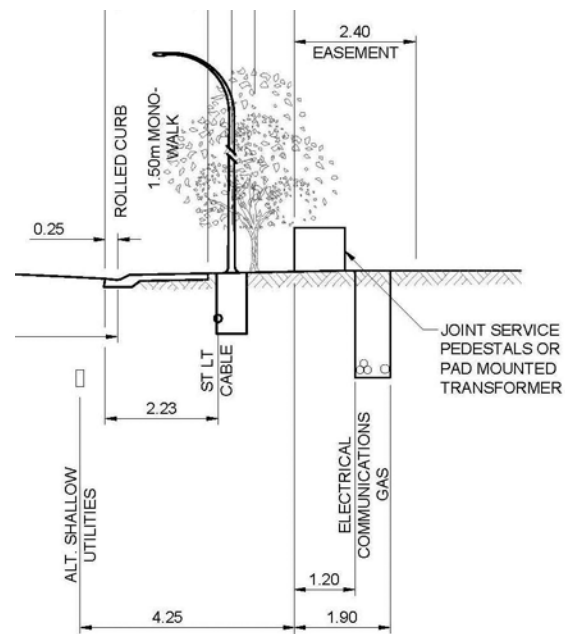

### 3.6.4 Public Realm Design

#### PUBLIC REALM CONCEPT

##### Definition

The Municipal Development Plan defined public realm as the space around, between and within buildings that are publicly accessible, including streets, squares, parks and open spaces. These areas and settings support or facilitate public life and social interaction.

##### Components

Public Realm of a street is the area between the face of the curb and the face of the building. It is the space dedicated for people of all ages. It allows for a variety of activities such as: walking, sitting, gathering, eating, listening, contemplating, playing, etc. The public realm is comprised of the following zones:

- Edge zone
- Furniture zone
- Pedestrian zone
- Frontage zone

##### Public Realm Highlights

Each year the City spends millions of dollars maintaining and improving city streets, yet too often the streets serve only a single purpose – the movement of automobiles. With improved planning and co-ordination, The City of Calgary could use this money to transform its streets to meet The City's many objectives for streets, including enhancement of all types of travel, improved ecological performance, encouragement of physical activity for public health, and restoring the streets' rightful role as the heart of the City's public life.

The Complete Streets program provides a blueprint for achieving this multi-use vision of streets – streets that continue to function as corridors of movement while at the same time reach their potential for enhanced community life, recreational opportunities, and ecological benefits. As the city of Calgary continues to grow, The Complete Streets program will help to ensure that it can fulfill its vision of a world-class city – one that is renowned not just for views from its streets, but for the quality of the streets themselves and the vibrant public life that they foster.

The public realm highlights are design criteria represented through detailed imagery to describe the environment to be created by applying these criteria, and they are:

##### Distinctive overall unified design

- Integrated site furnishings
- Pedestrian-oriented lighting
- Minimize site cluttering

##### Space for public life

- Reclaim existing street space for public use
- Safe public seating for neighbourhood gathering
- Merchant participating

##### Pedestrian safety

- Visible crossings
- Slower turning speed
- Shorter crossing distances

##### Universal design

- Generous unobstructed sidewalks
- Curb ramps for all users
- Accessible pedestrian signals

##### Creative use of parking lane

- Flexible use for cafe seating
- Permanent mini-plazas
- Landscaping in parking lane

##### Ecology

- Storm Water Management
- Permeable materials
- Streets as habitats

##### Extensive greening

- Healthy urban forest
- Expanded sidewalk plantings
- Utility consolidation

##### Integrating pedestrians and transit

- Transit rider amenities
- Bus bulbouts and boarding islands
- Safe, convenient routes to Transit

##### Reclaiming excess street space

- Street parks and new plazas
- Traffic circles
- Landscaped medians



PUBLIC REALM HIGHLIGHTS

Figure 3.6-13: Public realm highlights



*integrated site furnishing*



*universal design*



*extensive greening*



*reclaiming excess street space*



*pedestrian safety*



*creative use of parking lane*



*space for public life*



*integrating peds and transit*



*distinctive unified overall design*



*Ecology*

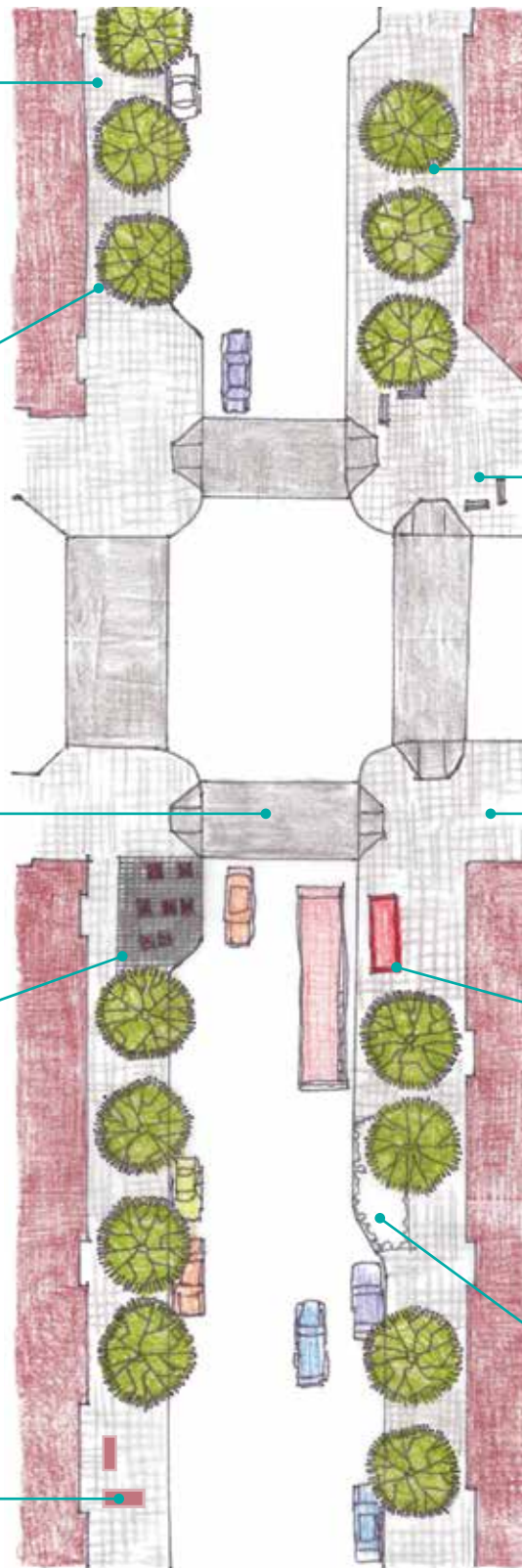



**PUBLIC REALM HIGHLIGHTS** (CONTINUED)

Figure 3.6-14: Public realm highlights

**Distinctive unified overall design**



*integrated site furniture*



*pedestrian oriented lighting*



*minimize street cluttering*

**Space for public life**



*reclaim excess street space for public use*



*safe seating for neighbourhood gatherings*



*merchant participation*

**Pedestrian safety**



*visible crossings*



*slower turning speed*



*shorter crossing distances*

**Universal design**



*generous unobstructed sidewalks*



*curb ramps for all users*



*accessible pedestrian signals*

**PUBLIC REALM HIGHLIGHTS** (CONTINUED)

Figure 3.6-15: Public realm highlights

**Creative use of parking lanes**



*flexible use for cafe seating*



*permanent mini plazas*



*landscaping in the parking lane*

**Ecology**



*stormwater management*



*permeable materials*



*streets and habitats*

**Extensive greening**



*healthy urban forest*



*expanded sidewalk plantings*



*underground utility consolidation*

**Integrated pedestrian and transit**



*transit rider amenities*



*bus pullouts*



*safe, convenient routes for transit*

**Reclaiming excess street space**



*street parks and new plazas*



*traffic circles*



*landscaped medians*



## PUBLIC REALM COMPONENTS

**Edge zone:** is the interface zone between the roadway and the public realm area

**Furniture zone:** is the area for all the street furniture, street lights, recycling and waste receptacles, bike racks, including trees, and acts like a buffer between the roadway and the pedestrian sidewalk

**Sidewalk zone:** is the area for pedestrian movement and should be clear from all obstacles

**Frontage zone:** is the area for outdoor seating and display, as well as signage: it could be within private or public land

**Sustainable SWMS:** this zone is for Storm Water Management Systems in conjunction with shallow utility alignments

**Roadway zone:** is the zone for parking and vehicular movement

**Parking area:** is the flexible zone for parking, pop-up patios and curb extensions

Figure 3.6-11: Public realm components

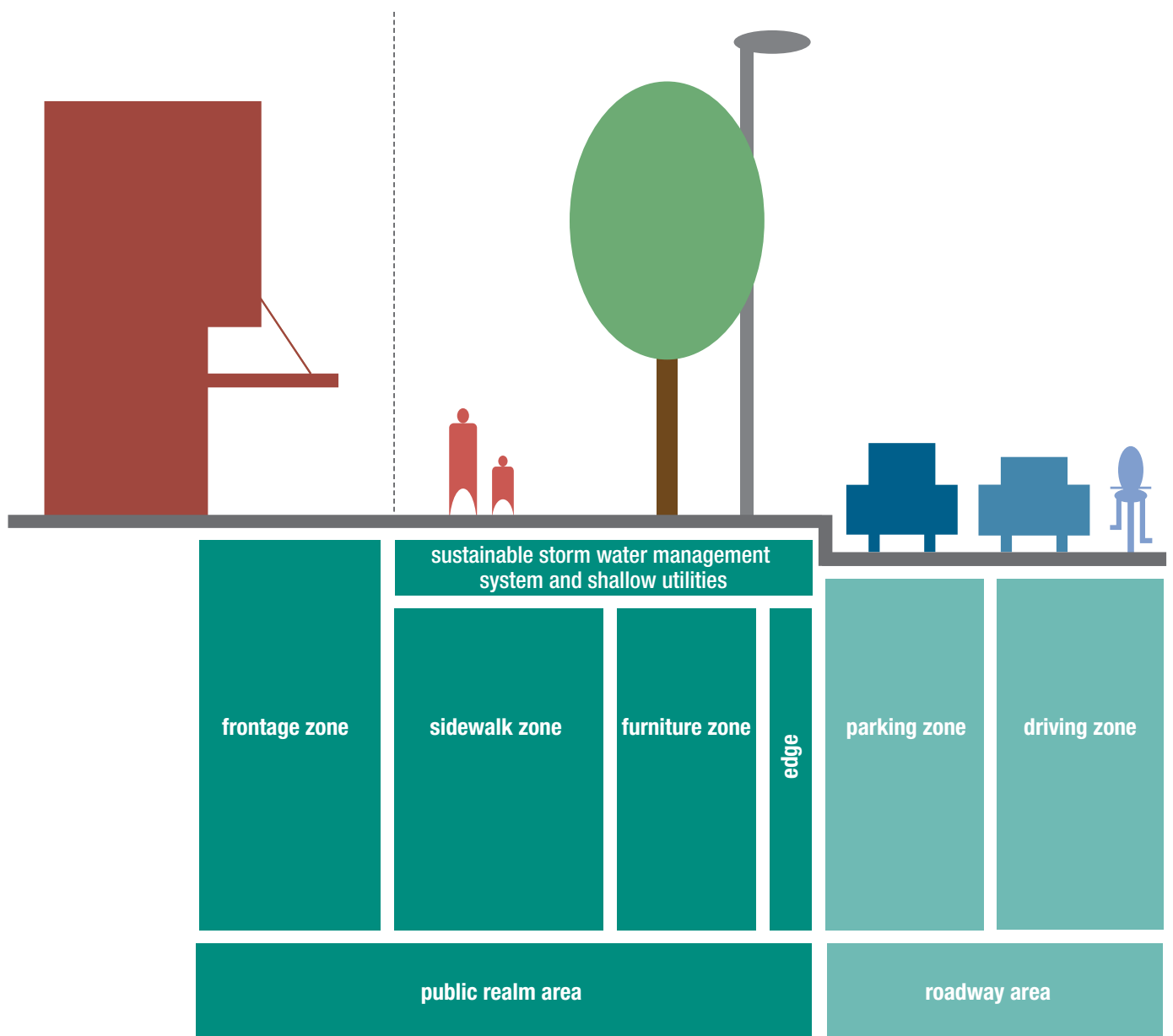

PUBLIC REALM ZONES

Figure 3.6-12: Public realm zones

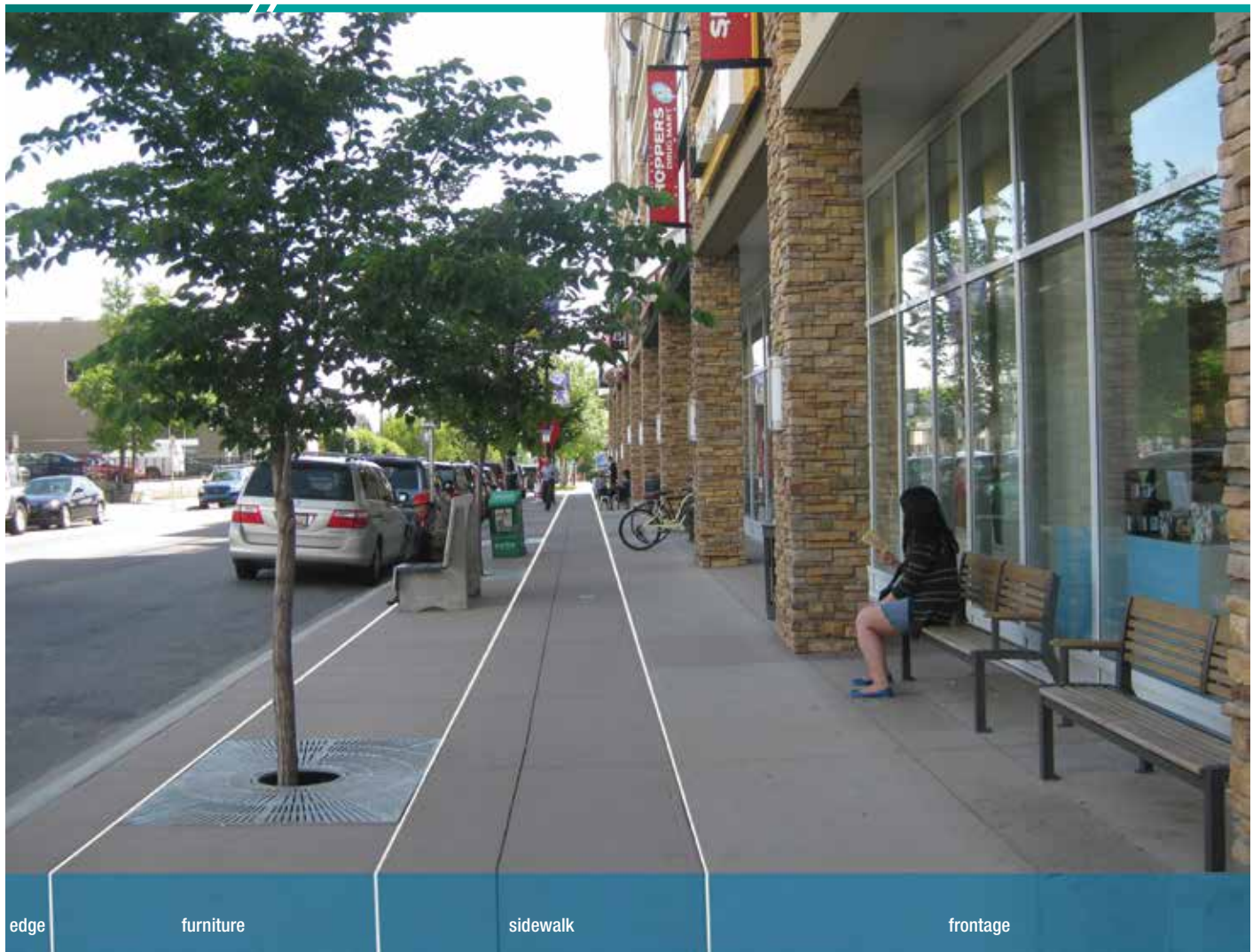

edge

furniture

sidewalk

frontage

## PUBLIC REALM ZONES

### bus zone amenities

Zones	Elements
Edge	Street lights, parking meters, signage poles, bollards, shallow utility boxes
Furniture	Trees and plantings, seating, bus zone amenities, bike racks, kiosks, public art, utility boxes, recycling and waste receptacles, other furnishings
Sidewalk	Paving material, underground shallow utilities
Frontage	Merchandise displays, café seating, furnishings, plantings along buildings

## FACTORS AFFECTING PUBLIC REALM WIDTHS

Zones	Elements
<b>Adjacent land use</b>	High intensity uses attract more pedestrians, generally necessitating greater sidewalk width
<b>Adjacent building form</b>	Taller buildings create greater shadow and scale; wider sidewalks can create great separation from the buildings, and allow more sun to reach sidewalks opposite tall buildings
<b>Adjacent ground floor</b>	Office and residential uses are often slightly set back to allow a transition from public to private spaces. In contrast, buildings with active ground floor uses typically front more directly onto the street and often spill into the sidewalk with seating or displays
<b>Roadway characteristics</b>	Pedestrians are typically more comfortable on sidewalks that are buffered from moving vehicles. Faster, higher volumes of cars and trucks require a wider buffer to create a comfortable walking environment. On-street parking and bicycle lanes can serve as buffers; where they are not present, additional sidewalk width and landscaping may be necessary



## STORMWATER FACILITIES

“Choice of stormwater facilities should be based on the context of the surrounding streetscape. These measures assume that a primary goal of the improvement is to mitigate stormwater effects. In addition to its impact on stormwater quality and quantity, multi-purpose design of stormwater facilities can add aesthetic value to the city by providing varied landscaping, visually appealing pavement design and enhanced community spaces. They can also be combined with traffic calming features. Stormwater tools can add health and value to the urban ecology by enhancing the linkage of existing parkways and parks for improved aesthetics and neighbourhood community spaces. In addition, these localized vegetated areas can create new habitat for wildlife, particularly birds and butterflies. Finally, by reducing total stormwater flows, the use of stormwater management tools may decrease the cost to the City of pumping and treating stormwater.”

*San Francisco Better Streets Plan*



*Chicago*



*San Diego, La Mesa*

## ANATOMY OF THE STREETS

The basic framework of a street is made up of the public street right-of-way (ROW); the setback area, which is private territory and acts as the transition between public and private; and the building walls, which provide the vertical dimension of the street space.

Figure 3.6-16: Anatomy of the street

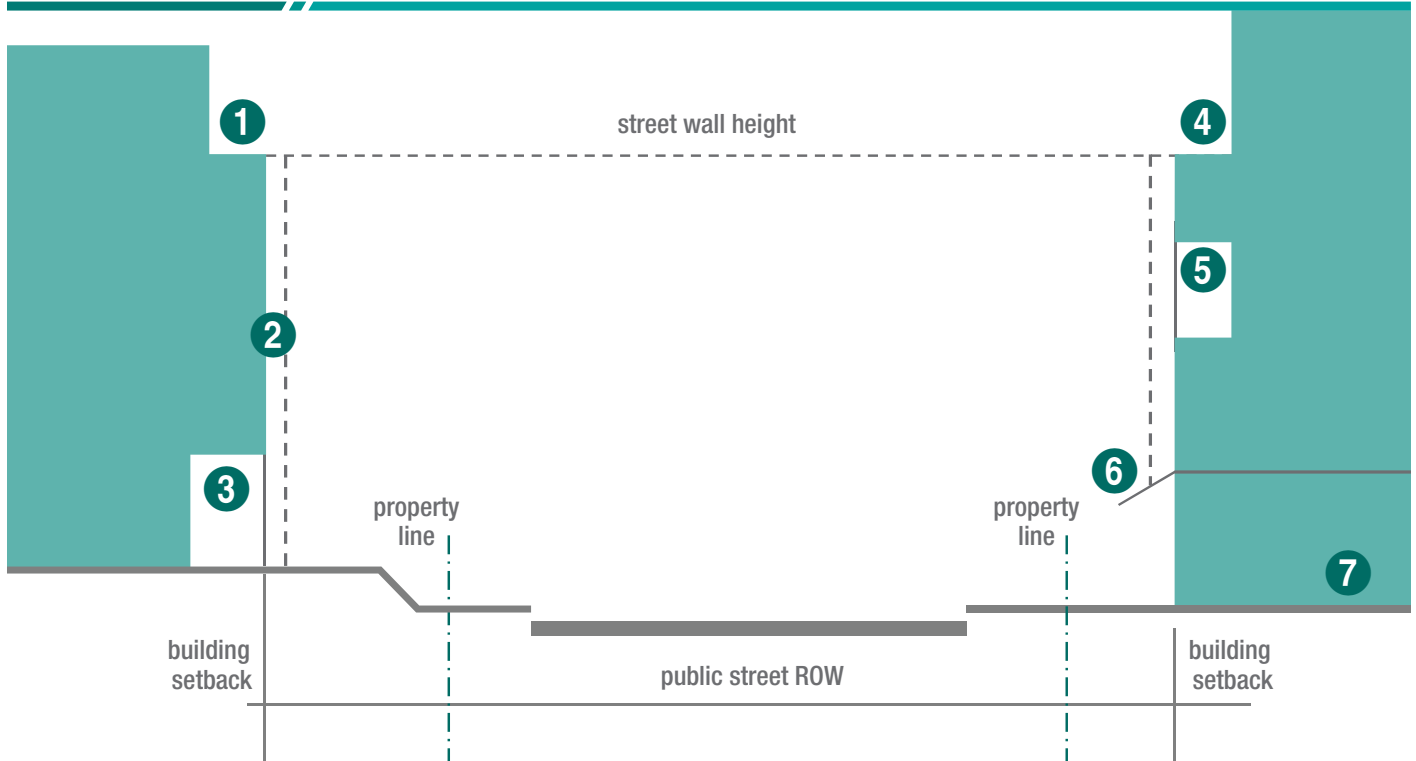

- 1 Step-back from street wall (defined as a condition where buildings consistently line or front onto the edge of a street). Best achieved when buildings have consistent setbacks built out to the sidewalk.
- 2 Balcony, bay window, canopy projection
- 3 Recessed entrances, stoops, terraces and raised ground floors for private residential entrances
- 4 Increased step-back for point towers on local streets preferred
- 5 Balcony partly recessed projection from street wall
- 6 Canopies for sidewalk projection on retail frontages
- 7 Ground floor level with sidewalk grade for live/work or retail

**“The component parts of the street should be thought of and designed comprehensively.”**

*Fort York Neighbourhood Public Realm Plan*

### STREET PROPORTIONS

The various types of streets should have different spatial proportions, as well as varied streetscape patterns, to reflect their roles in the neighbourhood.

The street proportion is the width of the street in relation to the height of street wall (defined as a condition where buildings consistently line or front onto the edge of a street). This is best achieved where buildings have consistent setbacks built out to the sidewalk.

The proportions vary according to the following:

- Context and land use of the street
- Function and spatial requirements
- Desirable relationship between the buildings and the street

The component parts of the street should be thought of and designed comprehensively. The basic framework of a street is made up of the public street ROW; the setback area, which is private territory and acts as the transition between public and private; and the building walls, which provide the vertical dimension of the street space.

This framework can be modelled, articulated and furnished to create a complete public space that is practical and spacious for its residents, and attractive to its visitors.

Figure 3.6-17: Street proportions

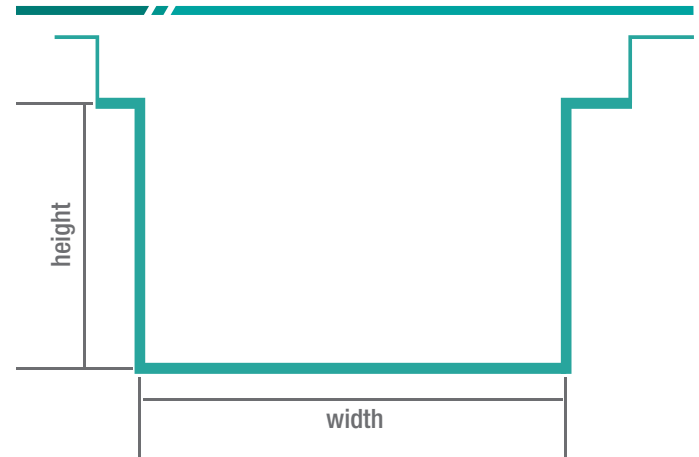

The proportion is the width of the street in relation to the height of street wall. The proportions vary according to the role of each street. The ratio creates a scale on-street that is comfortable to people and encourages walking. Human scale ratios fall between 1:3 and 1:2 as measured from the building fronts.

### STREETS AS PUBLIC SPACES

Streets should be seen as “urban rooms” with floors, walls, ceilings or canopies, and furnishings. The quality of this space relies heavily on the attention given to the design, materials and finishes applied to the area that is closest to the pedestrian.

Figure 3.6-18: Streets as public spaces



*New Orleans*



*La Jolla*



*La Jolla*



*New York City*

**STREET ACTIVITIES**

The best streets are supportive settings for a wide range of social and recreational activities:

- places for sidewalk games
- cycling
- strolling
- walking the dog
- porch sitting
- people watching
- window shopping
- unplanned social encounters that make for good gossip
- news gathering and conversation

Residents will often use their place on the street as a means of personal expression and a display of their horticultural expertise. Merchants use displays to inform and entice potential customers; restaurateurs expand their seating capacity in the summer months with outdoor café seating.

Figure 3.6-19: Streets – spaces and activities



*San Diego*



*New Orleans*



*New Orleans*

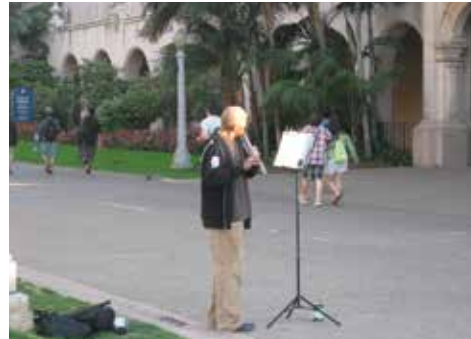

*San Diego*



# Chapter 3

## 3.7 Intersection Design

### 3.7 INTERSECTION DESIGN

#### 3.7.1 General

Most conflicts between street users occur at intersections where travellers cross each other's path. Conflicts for pedestrians and bicyclists are exacerbated due to their greater vulnerability, lesser size, and reduced visibility to other users. Good intersection design clearly communicates to those approaching the intersection what they must do, and who must yield.

This section describes features to improve safety, accessibility, and mobility for all users that are to be considered in the geometric design of intersections, including roundabouts. The benefits and constraints of features are examined, with a description of their appropriate land use and design.

#### ESSENTIAL PRINCIPLES OF INTERSECTION DESIGN

Intersection geometry is a critical element of intersection design, regardless of the type of traffic control used. The following principles apply to the design of all intersections:

- Intersections must be designed to safely accommodate all applicable modes of transportation;
- Good intersection designs are compact;
- Intersection design that creates unexpected conflicts between users should be avoided;
- Unusual conflicts should be avoided;
- Right-angle intersections are best for all users, since many intersection problems are worsened at skewed and multi-legged intersections;
- Free-flowing movements should be avoided at intersections; and
- Additional vehicular conflict points near the intersection should be removed through access management practices.

Geometry provides the basis to all users for traversing intersections and interacting with each other. The principles of intersection geometry apply to both street intersections and interchange on- and off-ramps.

#### INTERSECTION SPACING

Intersection (or access) spacing is dictated by the function of a street and land use it serves. In general terms, the higher the speed and the higher the intended vehicle capacity of a street, the larger the required intersection spacing. Figure 3.7-1 illustrates the approximate intersection spacing (in metres) for each classification within the CTP road and street palette.

Intersection spacing on Arterial Streets is most dependent on adjacent land use intensity and posted traffic speed. Larger intersection spacing is appropriate on streets in areas of lower densities (40 or less persons per hectare and 40 or less jobs per hectare) and with higher posted speeds (70 km/h). Shorter intersection spacing is appropriate in areas of greater density (greater than 40 persons per hectare and greater than 40 jobs per hectare) and with lower posted speeds (50 km/h).

Figure 3.7-1: Minimum Intersection Spacing

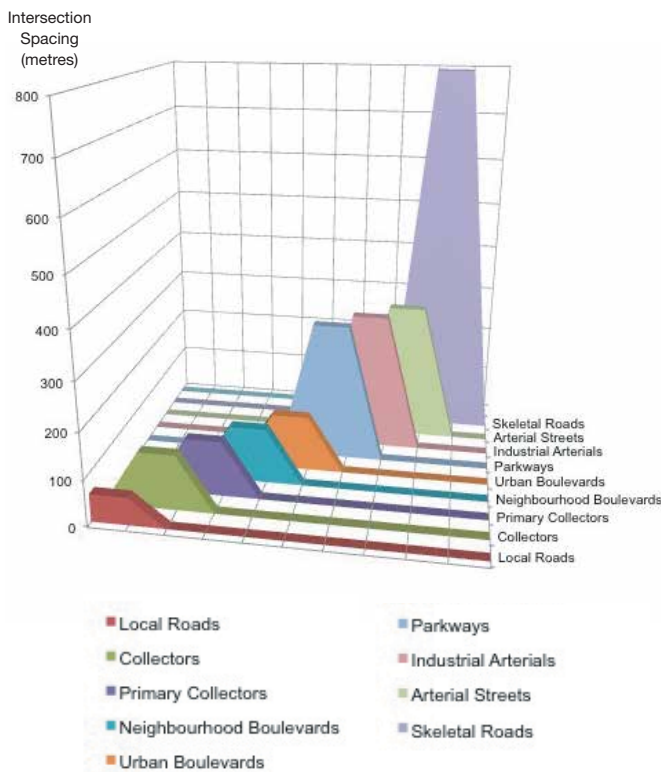

**INTERSECTION SKEW**

Skewed intersections are generally undesirable, because they introduce the following complications for all users:

- The travel distances across the intersection are greater, which increases exposure to potential conflicts and lengthens signal phases for pedestrians and vehicles;
- Skewed intersections often provide poor sight lines (this can be improved by reducing the skew angle); and
- Obtuse angles encourage speeding.

The maximum allowable intersection angle in Calgary is 75 degrees.

There are several solutions to help alleviate the problems associated with skewed intersections:

- Where possible, design or redesign the intersection closer to a right angle;
- Pedestrian refuges should be provided if the crossing distance exceeds 12 m;
- General-use travel lanes and bike lanes should be striped with dashes to guide cyclists and motorists through a long undefined area; and
- Where possible, convert intersection to Roundabout.

Figure 3.7-2, 3.7-3: NYC – Gansevoort Plaza – large skewed intersection treatment (before/after)



**MULTI-LEG INTERSECTIONS**

Multi-leg intersections (more than two approaching streets) are generally undesirable and introduce the following complications for all users:

- Multiple potential conflict points are added as users arrive from several directions;
- Users may have difficulty assessing all the approaches to identify all possible potential conflicts;
- At least one leg will be skewed; and
- Users must cross more lanes of traffic and the total travel distance across the intersections is increased.

There are several solutions to help alleviate the problems with multi-leg intersections:

- Wherever possible, design the intersection so there are no more than four legs. This is accomplished by removing one or more legs from the major intersection, and creating a minor intersection further upstream or downstream;
- As an alternative, one or more of the approach streets can be closed to motor vehicle traffic, while still allowing access for pedestrians and cyclists;
- A roundabout should be considered if the other options are not practical or if the setting is appropriate within a corridor;
- Pedestrian refuges should be created if the crossing distance exceeds 12 m; and
- General-use travel lanes and bike lanes may be striped with dashes to guide bicyclists and motorists through a long undefined area.

### 3.7.2 Intersection Corners

#### CORNER RADII

Intersection corners have a significant impact on the comfort and safety of motorized and non-motorized users. Smaller corner radii should be used whenever feasible, as they provide the following benefits:

- Smaller, more pedestrian-scale intersections;
- Reduced pedestrian crossing distance and crossing time;
- Slower vehicular turning speeds;
- Better geometry for installing perpendicular ramps for both crosswalks at each corner;
- Simpler, more appropriate crosswalk placement, in line with the approaching sidewalks, and
- Closer transit zones to street corner.

Figure 3.7-4: Tighter corner radii reduce crossing distance and slow turning traffic (Credit Michele Weisbart)

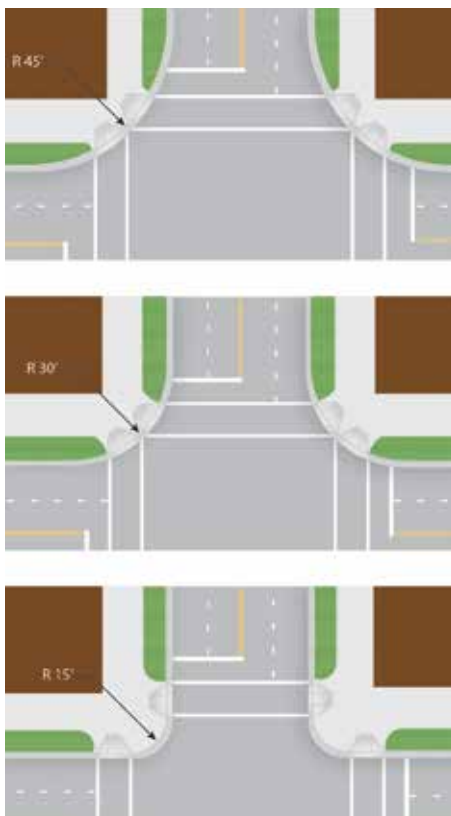

The implementation of corner radii must consider both the street classification and the land-use/vehicle setting. Smaller curb radii are not applicable on Skeletal Road or Industrial/Arterial Street intersections where larger vehicles travel more frequently.

The design vehicle for corner radii should facilitate movement of the most frequent users and consider that the most frequent vehicle is a passenger vehicle. The movement of larger vehicles (e.g., semi-tractor trailer) should be considered as a secondary requirement, and corner radii should be designed based on accommodating a larger design vehicle travelling at slow speed. In other words, the selected radii should facilitate the frequent user, yet still accommodate the infrequent user.

In addition, designers should consider the effect that bicycle lanes and on-street parking have on the effective corner radius, potentially increasing the ease with which large vehicles can turn.

Figure 3.7-5: Corner radius

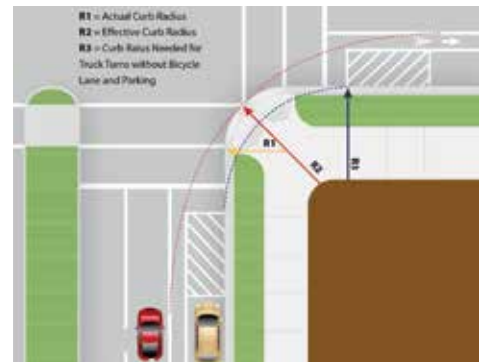

The following design vehicle principles should be applied when selecting corner radii for all street types other than Skeletal Roads, Industrial or Arterial Streets:

- Passenger vehicles must be able to turn from inside lane to inside lane without violating lane boundaries;
- HSU/ transit buses must not cross the centre line of the intersection approach, but may encroach into multiple receiving lanes (with the same travel direction);
- On Collector and Residential Streets, an HSU/transit bus may encroach partway into opposing traffic lanes;
- A WB-21 and emergency vehicles must be able to physically maneuver between fixed objects on all corners but are allowed to use the entire pavement width.

**CURB EXTENSION CORNER RADII**

Curb extensions, previously mentioned in Section 3.2.4 in Pedestrian Design, offer many community benefits:

- Reduced pedestrian crossing distance, resulting in less exposure to vehicles and shorter pedestrian clearance intervals at signals;
- Improved intersection safety (e.g., preventing “passing on the right” where pedestrian visibility is severely limited);
- Improved visibility between pedestrians and motorists;
- Control of parking near intersections;
- A narrowed roadway, which has a potential traffic calming effect;
- Additional room for street furniture, landscaping, and curb ramps;
- Slower turning vehicles; and
- Management of streetwater runoff.

Curb extensions are not applicable on Skeletal Roads and all classes of Arterial Streets in Calgary, but are applicable on the other street types.

**SELECTION OF CORNER RADII**

There are a large number of variables that influence the selection of corner radii. In order to streamline the process, a selection matrix was created that simplifies the input parameters. The matrix content was developed around the following variables:

- corners with and without curb extensions (four scenarios)
- streets with and without medians
- streets with and without bike lanes
- two- and four-lane roadways

Wheel paths for passenger cars, transit buses, and semi-tractor trailers were tested for the various corner configurations to determine minimum radii. An illustration of this for a four-lane streets with curb extensions and a median is shown in Figure 3.7-7.

Figure 3.7-6: The location of a curb extension affects the choice of corner radius

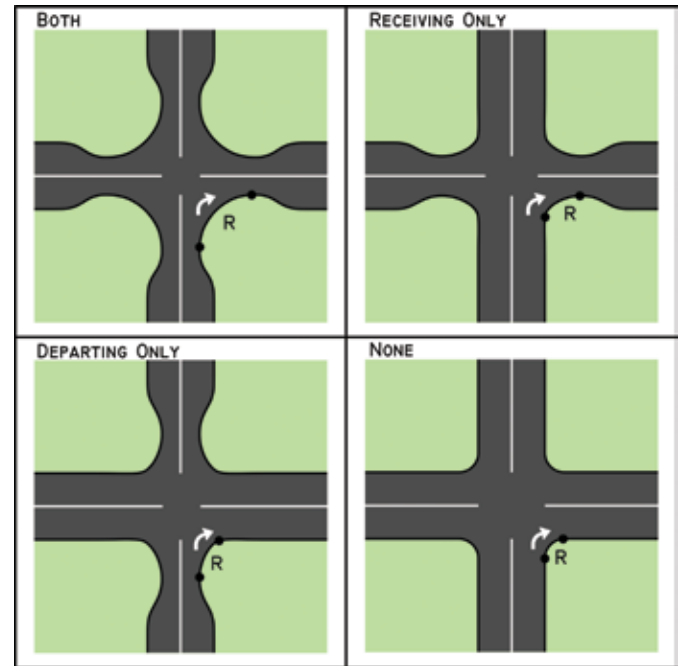

Figure 3.7-7: Auto turning templates

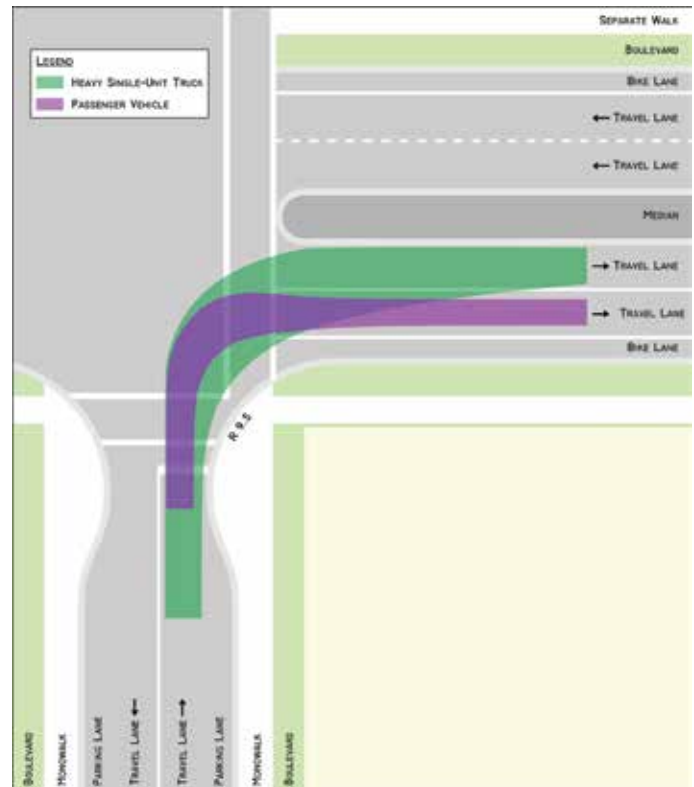
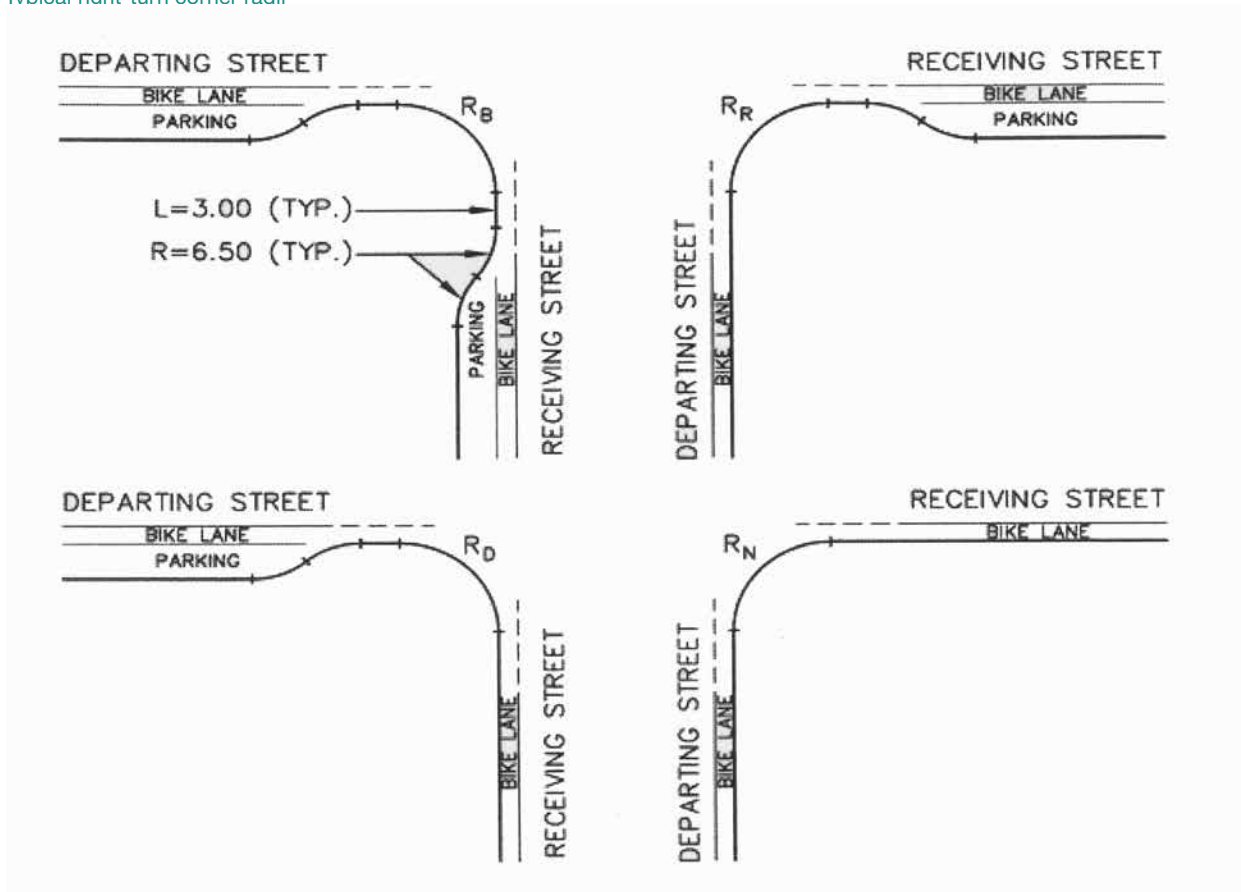

Figure 3.7-8: Typical right-turn corner radii



DEPARTING STREET	RECEIVING STREET	LIP OF GUTTER RADIUS			
		$R_B$	$R_D$	$R_R$	$R_N$
<b>URBAN BOULEVARD</b> (3.30+3.30+2.50B+2.90P)  (Design Vehicle = Transit Bus) (SU9 for Residential Entrance and Residential streets)	Local Arterial Street – no parking Parkway – no parking Urban Boulevard – no parking		7.5*		7.5*
	Urban Boulevard	7.5*	5.0*	7.5*	5.0
	Neighbourhood Boulevard Primary Collector Street Collector Street Activity Centre Street	12.5*	10.5*	12.5*	10.5
	Neighbourhood Boulevard – no bike lane	12.5*	9.0*	12.5*	9.0
	Primary Collectors Street – no parking		9.0*		9.0
	Collector Street – no parking		12.5*		12.5
	Collector Street – no bike lane	12.5*	12.5*	12.5*	12.5
	Residential Entrance Street		9.0*		9.0
	Residential Street	10.5*	9.0*	10.5*	9.0

**RIGHT-TURN CHANNELIZATION ISLANDS**

Right-turn lanes should generally be avoided on Liveable and Collector Streets as they increase pedestrian crossing distance, the size of the intersection, and the likelihood of conflicts between motorists turning on red and pedestrians crossing on green. In particular, right-turn channelization should be avoided in intersections having pedestrian, cycling and transit priority.

In cases where the intersection approach has a high (>200 vehicles per hour) right-turn volume, however, a right-turn lane may be the best solution to provide additional vehicle capacity without adding additional lanes elsewhere in the intersection. Where a channelized right-turn island is required, pedestrian safety and accessibility must be incorporated into their design.



For turns onto streets with only one through lane and where turning truck movement is rare, the best solution for pedestrian safety and comfort is to provide a small corner radius for the right-turn lane. At intersections of multi-lane streets where trucks make frequent right-turns, however, a raised channelized island between the through lanes and the right-turn lane is a good alternative to a large corner radius. This also enhances pedestrian safety and access.

If designed correctly, a raised island can achieve the following objectives:

- Allow pedestrians to cross fewer lanes at a time;
- Allow motorists and pedestrians to judge the right-turn/pedestrian conflict separately;
- Reduce pedestrian crossing distance, which can improve signal timing of all users;
- Balance vehicle capacity and truck turning needs, with pedestrian safety, and
- Provide an opportunity for landscape and hardscape enhancement (on the island).

The following design practices should be used for right-turn channelization islands, to provide safety and convenience for pedestrians, bicyclists, and motorists:

- Provide a yield sign for the turning lane;
- Provide at least a 60-degree angle between vehicle flows, which reduces turning speeds and improves the yielding driver's visibility of pedestrians and vehicles on the cross-street, and
- Place the crosswalk across the right-turn lane about one car length back from where the drivers yield to traffic on the other street, allowing the yielding driver to respond to a potential pedestrian conflict first, independent of the vehicle conflict, and then move forward.

**Figure 3.7-9: Traffic channelization is an effective mitigation strategy when intersection radii reduction is not an option**  
(Credit: Michele Weisbart)



**Figure 3.7-10: Sharper angles of channelized lanes are important to slow cars and increase visibility**  
(Credit: Michele Weisbart)

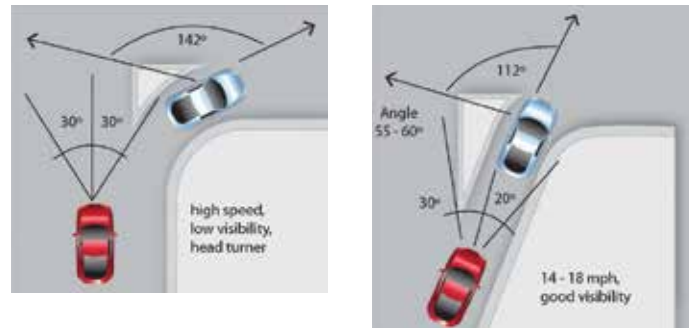

These safety goals are best met by creating an island that is roughly twice as long as it is wide. The corner radius will typically be large at the beginning (approach) of the island (45 to 90 m radius) followed by a smaller radius (six to 15 m) at the pedestrian crossing point. When creating this design, it is necessary to allow for large trucks turning into multiple receiving lanes.

For channelized island design where the right lane accommodates free-flow movements (i.e., no yield) into an exclusive receiving lane, pedestrians should be protected from the right-turning vehicles by a signal-controlled pedestrian walk phase.

### 3.7.3 Roundabouts

The City of Calgary approved a Roundabout Policy in April 2011.

The modern roundabout is a form of circular intersection where traffic flows counter-clockwise around a raised central island, thereby preventing vehicles from passing through the intersection on a linear path. Roundabouts improve intersection safety while increasing intersection capacity and reducing delay. Roundabouts also offer operating cost savings over traffic signals.

#### POLICY

The City of Calgary will use roundabouts as the preferred option of traffic control on Arterial and Collector Streets, in Greenfield areas where a new intersection is planned that warrants or may warrant a future traffic signal or all-way stop.

In existing developed areas, a roundabout should be considered where a traffic control upgrade is warranted, capital improvements are being considered, or safety and capacity issues have been identified.

If a roundabout is found to be inappropriate by an intersection control evaluation, an alternate method of intersection control may be used. The use of roundabouts in these circumstances will be at the discretion of the General Manager, Transportation.

The above policy applies in several project areas:

- New development
- Capital projects
- Replacement activities

When possible, outline plans approved prior to the adoption of the Roundabout Policy should be re-examined with the developer for potential roundabout usage.

### GUIDELINES

Transportation Planning has developed Roundabout Guidelines including design, ROW requirements, and landscaping. The document is available for viewing or downloading at [www.calgary.ca](http://www.calgary.ca). Use “Roundabout Guidelines” in the search field.

### 3.7.4 Elements of a Good Intersection

There are several elements of good intersection design covered throughout this chapter. Figure 3.7-12 summarizes those elements graphically.

Figure 3.7-11: Roundabout

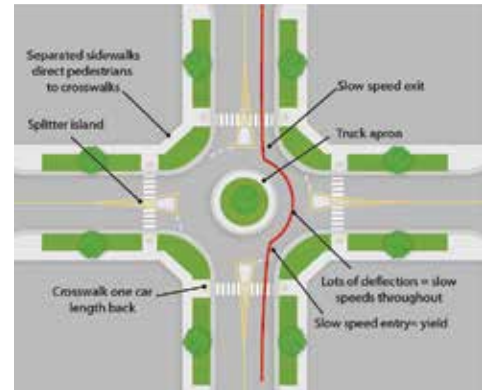
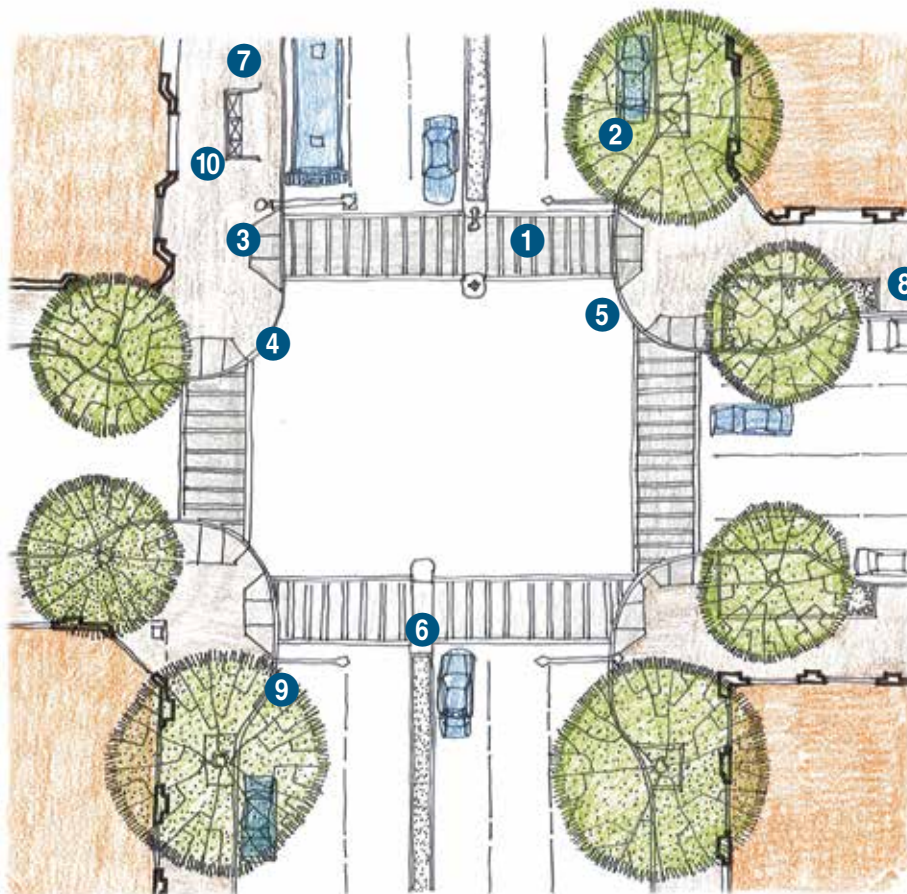

Figure 3.7-12: Elements of a good intersection



- 1 Visible crosswalks
- 2 Parking restrictions at corners
- 3 Curb ramps
- 4 Tight curb radii
- 5 Curb extensions
- 6 Pedestrian refuge islands
- 7 Accessible transit stops
- 8 Street trees and landscaping
- 9 Street and pedestrian lighting
- 10 Seating and other site furnishings

### 3.7.5 New Intersection Detailed Plans

All detailed intersection plans reside in the updated 2014 Design Guide for Subdivision Servicing.



# Chapter 3

## 3.8 Access Management

### 3.8 ACCESS MANAGEMENT

---

As discussed in Chapter 2, there are many benefits of having well-connected street networks. Yet a major challenge in street design is balancing the number of access points to a street, as most conflicts between users occur at intersections and driveways. A large number of driveways and intersections increases potential conflict between vehicles, cyclists, pedestrians and bus traffic.

Where possible, new driveways should be minimized and old driveways should be eliminated or consolidated, and raised medians should be placed to limit left turns into and out of driveways. Care should be taken to consult with and consider the use, circulation, and economic needs of the businesses/developments affected.

Access management, through limiting driveways and providing raised medians, has many benefits:

- The number of conflict points is reduced, especially by replacing centre-turn lanes with raised medians, as left turns by motorists account for a high number of accidents with cyclists and pedestrians;
- Pedestrian crossing opportunities are enhanced with a raised median by providing a pedestrian refuge;
- Universal access for pedestrians is easier, since the sidewalk is less frequently interrupted by driveway slopes and vehicular movements; and
- Improved traffic flow may reduce the need for street widening, allowing part of the protected ROW to be recaptured for other users.



The following possible negative effects of access management should be considered and addressed:

- Streamlining a street may increase motor vehicle speeds and volumes, which can be detrimental to other users (pedestrians, cyclists);
- Reduced access to businesses may require circuitous travel for all users, including pedestrians and cyclists, and
- Adjacent businesses and residents can experience decreased access.

Figure 3.8-1: Adding medians and consolidating driveways to manage access (X = conflict point)  
(Credit: Michele Weisbart)

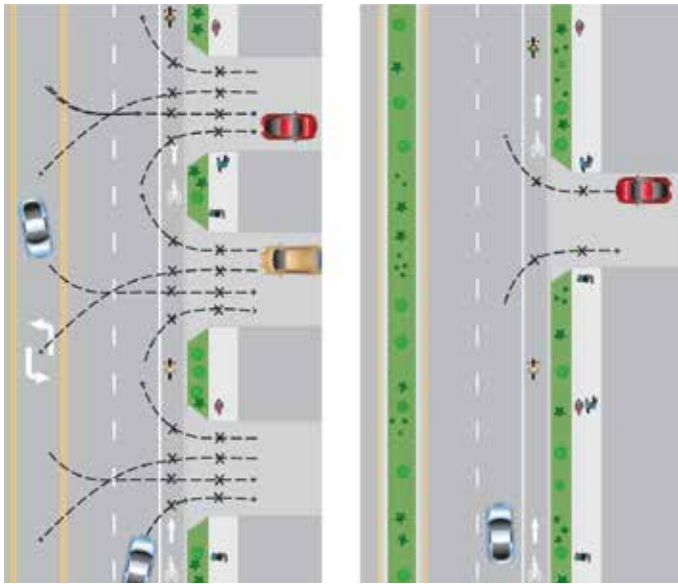

Figure 3.8-2, 3.8-3: Reconstructed corner with fewer, narrower driveways (Credit: Michele Weisbart)



before

after

For Complete Streets, the Access Management Strategy that has been developed is based on the following assumptions:

**1. General Assumption**

Designers must prove that the proposed access location(s) are sound in terms of currently recognized standards of operation and safety of the transportation system.

**2. Additional Assumptions**

- Location and configuration of each access or access scheme (in cases of multi-lot developments) will be considered on a site-specific basis;
- Access to Skeletal, Arterial and, to some degree, Collector Streets should be limited to protect integrity of these primary sections of the transportation system for regional and inter-regional mobility;
- Location of accesses should be considered only outside of the intersection turning lanes and at such an offset as to avoid interference with the operation of the intersection;
- Location of accesses should always provide adequate site distances;
- No individual accesses should be permitted to the roundabouts and within the splitter islands;
- No access should be permitted within the length of (i.e., opposite to) the dedicated left turning bay;
- No frontage and back alley accesses will be considered for the same parcel;
- Minimum standard spacing between residential driveways should reflect minimum building offset from property line; and
- Non-standard access configurations may be considered by the Transportation Department with supporting technical analysis.



In addition, the following information must be considered in the design of accesses:

### **GENERAL COMMENTS**

The configuration of the local transportation network should be utilized to provide for adequate access.

Should modification of the layout of the arterial or collector street be required to improve access to a specific area, the designer should carry out and provide results of the technical analysis supporting such initiative, before modification can be considered by Calgary Transportation.

### **SKELETAL ROADS**

No direct access will be considered to Skeletal Roads other than at the intersection and/or future interchange locations established by Calgary Transportation. Once such locations are selected they will not be subject to relocation.

### **ARTERIAL STREETS**

The minimum intersection spacing for Arterial Street and Industrial Arterial Street is 300 m, although lesser spacing will be considered subject to satisfaction of the approving authority. Direct access on Arterial Street and Industrial Arterial Street is only allowed to adjacent commercial and industrial properties subject to traffic and design conditions and is generally restricted to right- turns in and out.

The minimum intersection spacing for Local Arterial Street is 150 m if no left turn bays are required, 220 m intersection spacing will be required if back to back left turn bays are required. Direct access on Local Arterial Street is only allowed to adjacent commercial and multi-residential properties subject to satisfaction of the approving authority.

### **LIVEABLE STREETS**

Direct access on Parkway Street is generally restricted to adjacent properties.

Direct access on Urban Boulevard and Neighbourhood Boulevard Streets is not permitted to adjacent industrial and residential properties, while the direct access to adjacent commercial and multi-residential properties is generally restricted. Access to properties should be allowed from back lane.

Where feasible, on-street parking should be protected by “bulbing” of street corners at the intersections and/or mid-block crossings.

## **LOCAL STREETS**

- 1. Primary Collector Street** – a street that provides continuous connection through more than one subdivision. Direct access on Primary Collector is permitted to adjacent properties but is generally restricted to right-turns in and out.
- 2. Activity Centre Street** – a street that supports activity centres in addition to commercial and residential land uses. Direct access on Activity Centre Street is restricted to industrial and residential properties, direct access is generally not permitted to adjacent commercial and multi-residential properties. Although, access to properties should be allowed from back lane.
- 3. Collector Street** – a street that functions as a collector-distributor road accommodating internal traffic to the subdivision. Direct and back lane access on Collector Street is permitted to adjacent properties.
- 4. Industrial Street** – a street that provides direct access to adjacent industrial and commercial properties.
- 5. Residential Street** – a street that provides direct access to adjacent residential and multi-residential properties. Direct access on residential street to adjacent commercial properties is restricted.



# 4

## Chapter 4 Retrofit Street Design Guidelines and Process

### 4.1 CONTEXT SENSITIVE DESIGN

---

Context Sensitive Design (CSD) is a collaborative, interdisciplinary, holistic approach to the development of transportation projects. It is both process and product, characterized by a number of attributes. It involves all stakeholders, including community members, elected officials, interest groups, and affected municipal, provincial, and federal agencies. It puts project needs and both agency and community values on a level playing field, and considers all trade-offs in decision-making.

The Context Sensitive Solutions (CSS) process differs from traditional planning processes in that it considers a range of goals that extend beyond those that are associated with only addressing transportation problems. It includes goals related to community liveability and sustainability, and seeks to identify and evaluate diverse objectives earlier in the process with greater participation by those affected.

The result is greater consensus and a streamlined project during later stages of project development and delivery.

While CSS processes are often associated with design, the approach is most effective when used during each step of planning and project development – from long-range transportation plans to individual corridor strategies.

*Adopted from: FHWA Context Sensitive Solutions Primer*

**CONTEXT**

Within the CSS process, context refers to the natural or built environment created by the land, topography, natural features, buildings and associated features, land use types, and activities on property adjacent to streets and on sidewalks, and a broader area created by the surrounding

neighbourhood, district, or community. Context also refers to the diversity of users of the environment. As Figures 4.1-1 and 4.1-2 show, there are large differences in the features of an urban and rural environment.

*Adopted from: FHWA Context Sensitive Solutions Primer*

Figure 4.1-1: Urban context

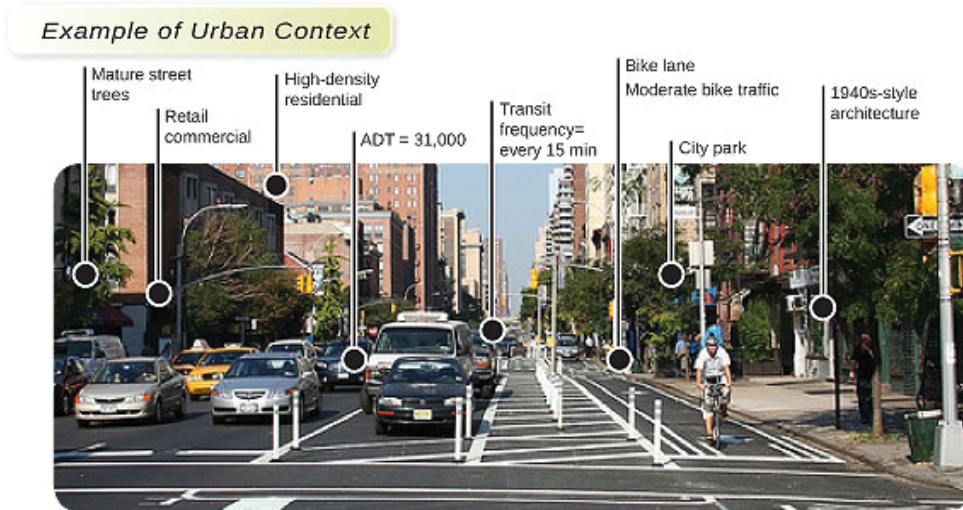
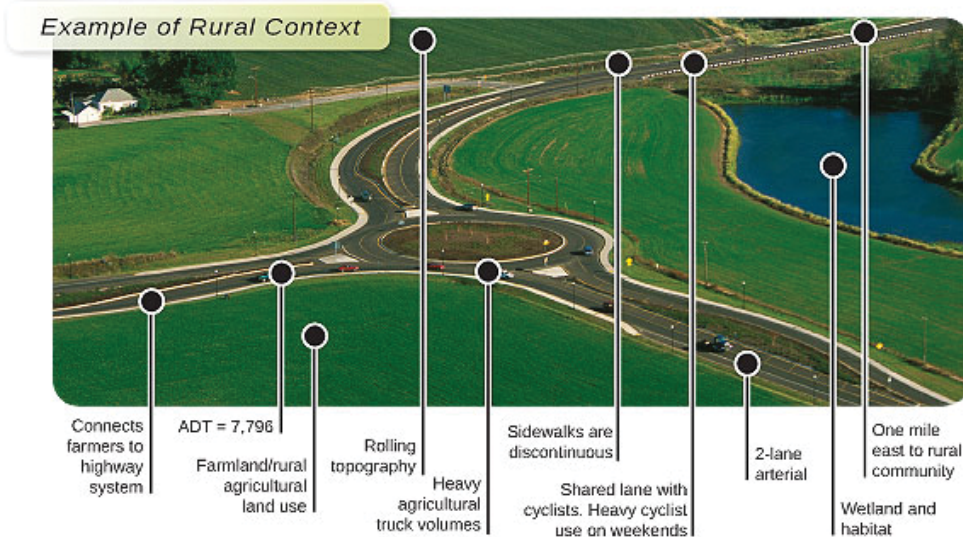

Figure 4.1-2: Rural context



Beyond function and design of a transportation facility, context includes the built and natural environments as well as social, cultural, and economic aspects (e.g., Triple Bottom Line).

**COLLABORATION: Internal Stakeholders**

In recent years, The City of Calgary has experienced challenges with “inclusive project ownership.” For example, corridor reviews driven by area structure plans or local area plans have been led by Land Use Planning. Conversely, corridor reviews driven by network capacity issues have been led by the Transportation Department. The issue is less about “who leads the project?” than the traditional process, which has not adequately informed the affected internal departments/stakeholders about the project, nor has it requested their input early enough in the project, if at all.

Figure 4.1-3 illustrates that while Transportation may be the primary stakeholders of the roadway, and Planning the primary stakeholders of the building interface, collaboration between the departments in the boulevard and set-back areas is critical. In addition, Water Resources, Utilities, Urban Forestry and other groups are important stakeholders in these areas. Success of a project depends on collaboration with these groups as early as possible.

Figure 4.1-3: Collaboration between departments

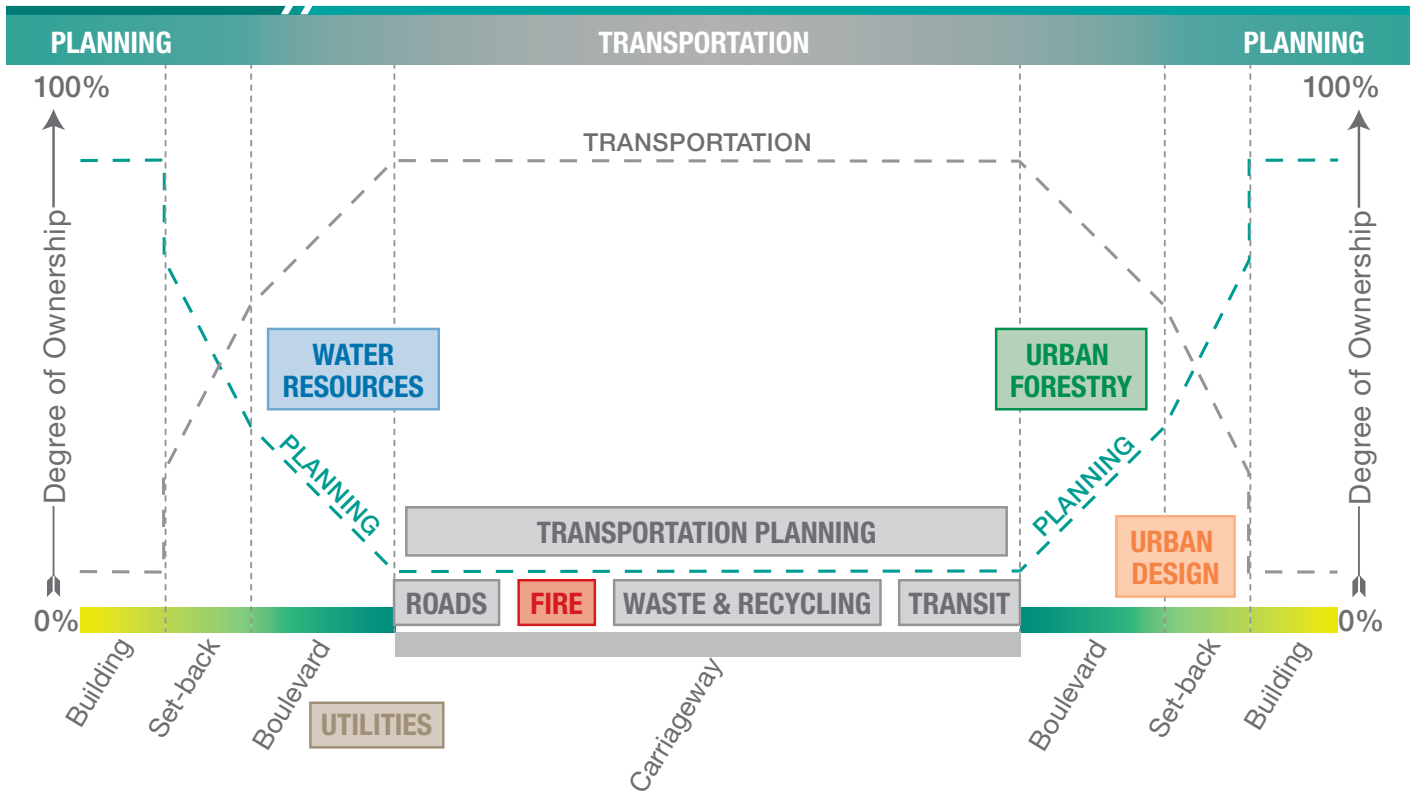



**COLLABORATION: External Stakeholders**

In most transportation planning studies that are retrofit situations (e.g. limited space), changing a street from its current form into a desired future form is a complex problem. As Figure 4.1-4 illustrates, a complex problem cannot be solved without:

- a) A clear understanding of the context of the project area (land uses, mobility patterns, built form, community fabric, redevelopment opportunity, etc.);
- b) Technical information about the corridor (road width, traffic volumes, transit volumes, current and proposed densities, etc.); and
- c) Input from the community about their issues and concerns.

This process rarely generates just one alternative. Further, this process inevitably brings forward more information about the problem being addressed that was not evident at the start of the project. Hence the process is cyclical until the alternatives are narrowed down to one preferred, collaboratively developed solution.

Figure 4.1-4: Collaboration between external stakeholders



**TRADITIONAL VS. COLLABORATIVE APPROACH**

As shown by the graphs below, a collaborative planning approach becomes less contentious as the implementation stage approaches. This community participation and decision-making process allows stakeholders to influence outcomes by raising issues early while they can still be addressed. Public and stakeholder involvement might be a primary activity early in the project, but by the time engineers are producing detailed plans, stakeholders only wish to be kept informed about progress and involved when changes arise.

Figure 4.1-5: Traditional approach



Figure 4.1-6: Collaborative approach



**KEY BENEFITS OF A COLLABORATIVE PLANNING APPROACH**

- The project is in harmony with the community, and it preserves environmental, aesthetic, historic, and natural resource values of the area;
- The project meets the needs of all users and the community, with safety as a priority;
- The project solves problems and satisfies the purpose and needs identified by a full range of stakeholders;
- The project meets the needs of both designers and stakeholders and is perceived as adding lasting value to the community as a whole; and
- The project involves efficient and effective use of resources (time, budget) of all involved parties.

## RETROFIT PROCESS

To help guide the wide range of retrofit projects for the Transportation and Planning departments, an eight-step retrofit process (Figure 4.1-7) has been developed. The steps are explained in more detail below.

### Step 1: Identify Project Scale/Type

The City is engaged in a wide range and scale of transportation planning, design and construction – from large-scale network and corridor studies to small-scale traffic calming and various street improvement installations. It is important to first establish the project scale and type. This will determine which business unit is to lead, and how large the project team should be.

### Step 2: Identify Stakeholders and Assemble Team

After the project type and scale have been established, a team consisting of internal stakeholders, external stakeholders, and consultant(s) appropriate for the project should be assembled.

### Step 3: Identify Mobility and Land Use Context and Priorities

Using the CTP, MDP and other relevant Policy documents, establish the mobility and land use context by answering these questions:

- Does the project land on any Primary Networks?
- Is the available right-of-way limited? Is there opportunity to widen?
- Can on-street parking be added or removed?

### Step 4: Define Project Purpose, Vision & Priorities

The newly formed project team collectively defines the project purpose and vision, as well as the project

timeline, level of engagement, expectations, and priorities. Forming and agreeing on a Project Priority Triangle will assist the project team when determining trade-offs (Step 7). If pedestrian realm and street trees, for example, are important for the vision of the project, these should be placed at the top of the triangle, so all generated alternatives would include these elements.

### Step 5: Identify Constraints and Opportunities

Using technical input (e.g. road right-of-way, constraints based on roadway geometrics, short-term redevelopment opportunities, new technologies) identify constraints within which the project must develop. Use these constraints to generate potential opportunities.

### Step 6: Identify Alternatives

Given the context from Step 4 and the constraints/opportunities from Step 5, generate logical alternatives to be evaluated.

### Step 7: Evaluate Alternatives (trade-offs)

As a team, evaluate the alternatives, then prioritize and eliminate less practical alternatives. In a retro-fit situation, trade-offs are inevitable. The evaluation phase may generate new alternatives, which must go through Step 6, to ensure appropriateness with established context. Steps 6 and 7 are iterative until a single preferred alternative is chosen. Use the previously developed Project Priority Triangle (Step 4) to guide this evaluation process.

### Step 8: Proceed with Preferred Alternative

Once a preferred alternative has been chosen, proceed with detailed design, cost estimation, etc. depending on the type of project.

Figure 4.1-7: Retrofit process

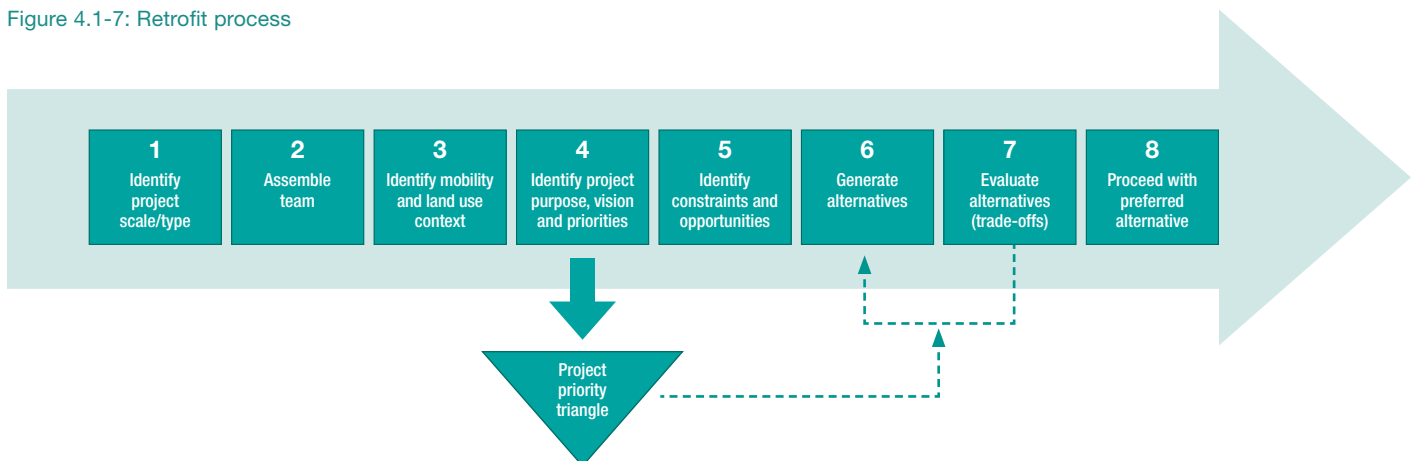

## 4.2 CONSTRAINED CORRIDORS

Existing City of Calgary street standards often do not accommodate pedestrians and cyclists to the extent that this Guide encourages. In addition, many street classifications do not accommodate green infrastructure and other public realm elements. With buildings built as close to the existing road ROW as the set-backs in the Land Use Bylaw allow, most of Calgary’s retrofit projects involve a finite constrained ROW. Trade-offs will be necessary as a preferred design solution is chosen (e.g., steps 6 and 7 in the retrofit process).

## 4.3 PRIMARY CORRIDORS

Primary Corridors are identified on the Transportation Maps of the Calgary Transportation Plan. Primary Corridors have been identified for the Cycling (Map 1), Transit (Map 2), Goods Movement (Map 5), and High Occupancy Vehicle (HOV) (Map 6) networks. In many instances, corridors accommodate more than one primary network. Whether new or retrofit design, special consideration must be given to these Primary Corridors. A Primary Cycling Corridor, for example, should allocate dedicated space in excess of the minimum widths (e.g., wider bike lanes, cycle tracks, and/or pathways).

Table 4.3-1: Desired widths for primary corridors

DESIRED WIDTHS FOR PRIMARY CORRIDORS			
Network	Travel lane/dedicated lane	On-street bike	Off-street bike
Primary cycle		2.0 m (bike lane) 2.0 m (1-way cycle track) 3.0 m (2-way cycle track)	3.5 m multi-use pathway
Primary transit	3.5 m (high frequency bus, shared travel lane – required for Arterial Street (4-Lane and 6-Lane) and Residential Entrance Street) 3.3 m (high frequency bus, shared travel lane, except Arterial Street (4-Lane and 6-Lane) and Residential Entrance Street) 3.5 m (BRT, shared travel lane) 3.5 m (bus only lane) 12 m (median BRT lanes w/platforms) 16 m (LRT – high radius) 18 m (LRT – low radius) 21 m (LRT + central load station) 23 m (LRT + side load station)		
Primary goods	3.7 m (shared travel lane)		
Primary HOV	3.7 m (HOV only lane)		

## 4.4 COMPLETE CASE STUDIES

Figure 4.4-1: Complete case study locations

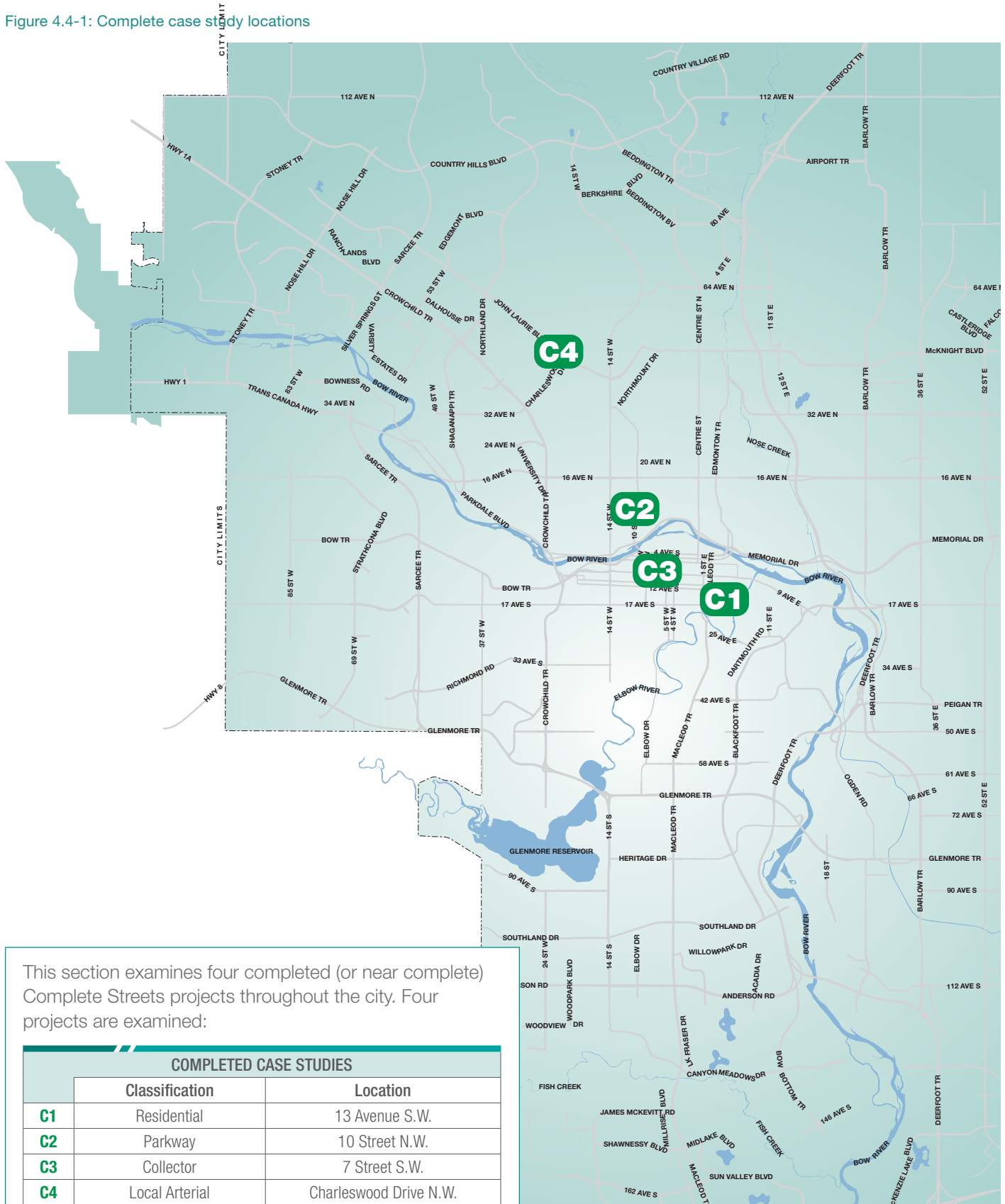

This section examines four completed (or near complete) Complete Streets projects throughout the city. Four projects are examined:

COMPLETED CASE STUDIES		
	Classification	Location
C1	Residential	13 Avenue S.W.
C2	Parkway	10 Street N.W.
C3	Collector	7 Street S.W.
C4	Local Arterial	Charleswood Drive N.W.

The locations are illustrated on the map in Figure 4.4-1.

**Case Study – C1**

**Residential:** 13th Avenue S.W. Heritage Greenway (Elbow River to 19th Street W)



**Site Location/Project Objective**

Still under construction, the objective is to create a ‘green loop’ around the Centre City, linking the pathways of the Bow and Elbow Rivers to create an “Emerald Necklace” through the Centre City – a recreational loop for users. Redevelopment of 13th Avenue from the Elbow River to 19th Street West will complete this recreational loop.

**Before**

Two-way traffic on two wide travel lanes with parking on both sides and a large amount of sidewalk space available.



CS-1a: Existing cross-section

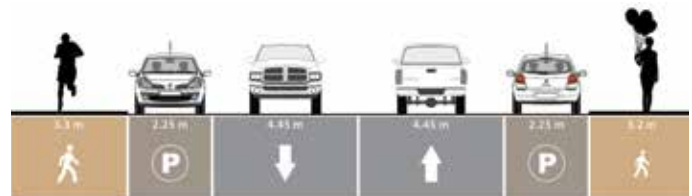

**After**

Travel lanes narrowed and parking removed from one side. Additional boulevard width allows for street trees/shrubs on one side of the street and a double row of trees and cycle track on the other side.



CS-1b: Complete cross-section

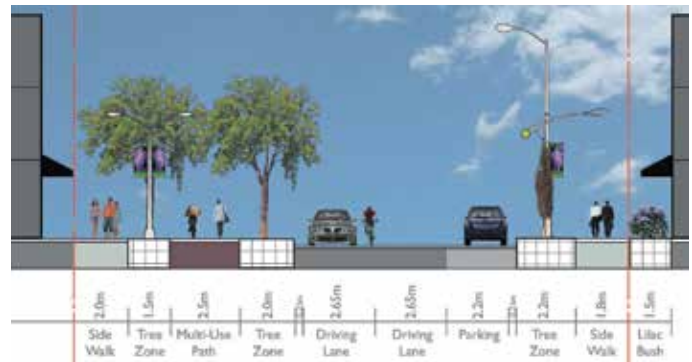



**Case Study – C2**  
**Parkway: 10th Street N.W.**

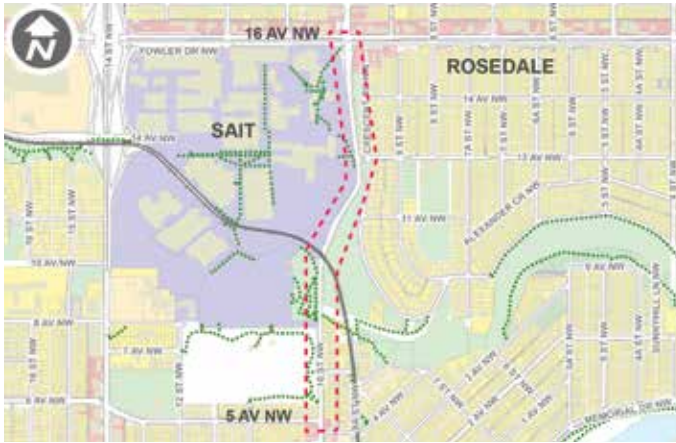

**Site Location/Project Objective**

10th Street is situated in northwest Calgary in the communities of Sunnyside and Rosedale. The project objective was to take advantage of a planned surface overlay (repaving) of 10th Street and repurpose the four-lane street width to better accommodate cyclists travelling between communities north of 16th Avenue and employment, retail, and post-secondary uses to the south at low cost.

**Before**

Four travel lanes (2 northbound, 2 southbound), sidewalks both sides (narrow west side).



CS-2a: Existing cross-section

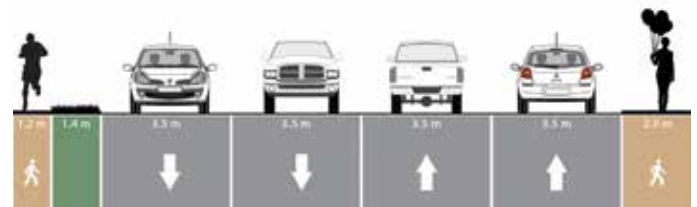

**After**

Southbound travel lane removed. Well-sized northbound and southbound 1.75 m painted and signed bicycle lanes introduced. Sidewalks unchanged.



CS-2b: Complete cross-section

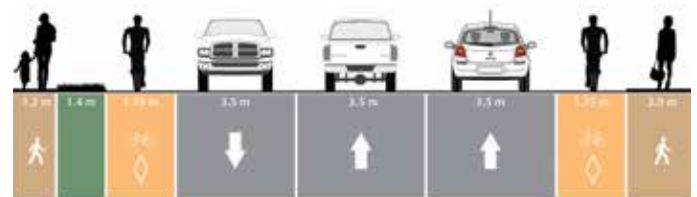

**2013 Update**

Pilot project data from 2012 was analyzed in early 2013. Bicycle volumes have doubled since implementation. Vehicle travel delays remain unchanged. Pilot project has ended. Bicycle lanes have been made permanent.

**Case Study – C3**

Collector: 7th Street Cycle Track, S.W.



**Site Location/Project Objective**

Following the direction of the Calgary Cycle Strategy, the project objective was to introduce protected bicycle infrastructure along key corridors in the downtown to connect the Bow River pathway crossings (e.g., Peace Bridge) to destinations within the core. This is the first of many cycle tracks to be constructed in the City of Calgary.

**Before**

Two travel lanes (southbound) and parking on both sides. Street trees and adequate sidewalk space on both sides.



CS-3a: Existing cross-section



**After**

Two travel lanes (southbound) and parking one side only (west side). Remaining pavement width utilized for a 3.10 m two-way cycle track protected by a 1.0 m raised concrete island.



CS-3b: Complete cross-section





## Case Study – C4

**Local Arterial:** Charleswood Dr. N.W.

### Site Location/Characteristics

Charleswood Drive is situated in northwest Calgary in the community of Charleswood. It is classified as a Local Arterial and connects 32nd Avenue N.W. to John Laurie Boulevard and carries 9,000 to 13,000 vehicles daily.



The existing land use and activity characteristics along Charleswood Drive are summarized in the table below.

Site Characteristics	
Context	Single detached dwellings, open spaces, local commercial.
Activity	Walking and cycling.
Function	Slow traffic, bike route.
Land Use	Residential.
Intersections	Pedestrian friendly.



### Before

The existing roadway provided two main driving lanes in each direction, and enough pavement width to accommodate an additional travel lane or parking lane in each direction. There were no on-street bicycle facilities. Shoulder lanes were underutilized and often had gravel during the winter/spring months.



### After

Complete Street Improvements:

- 1 Median with trees and wood mulch.
- 2 Bike lanes each direction.
- 3 Parking lanes.
- 4 Curb extensions at intersections.
- 5 Improved pedestrian crossings.

### 4.5 FUTURE CASE STUDIES

Figure 4.5-1: Future case study locations

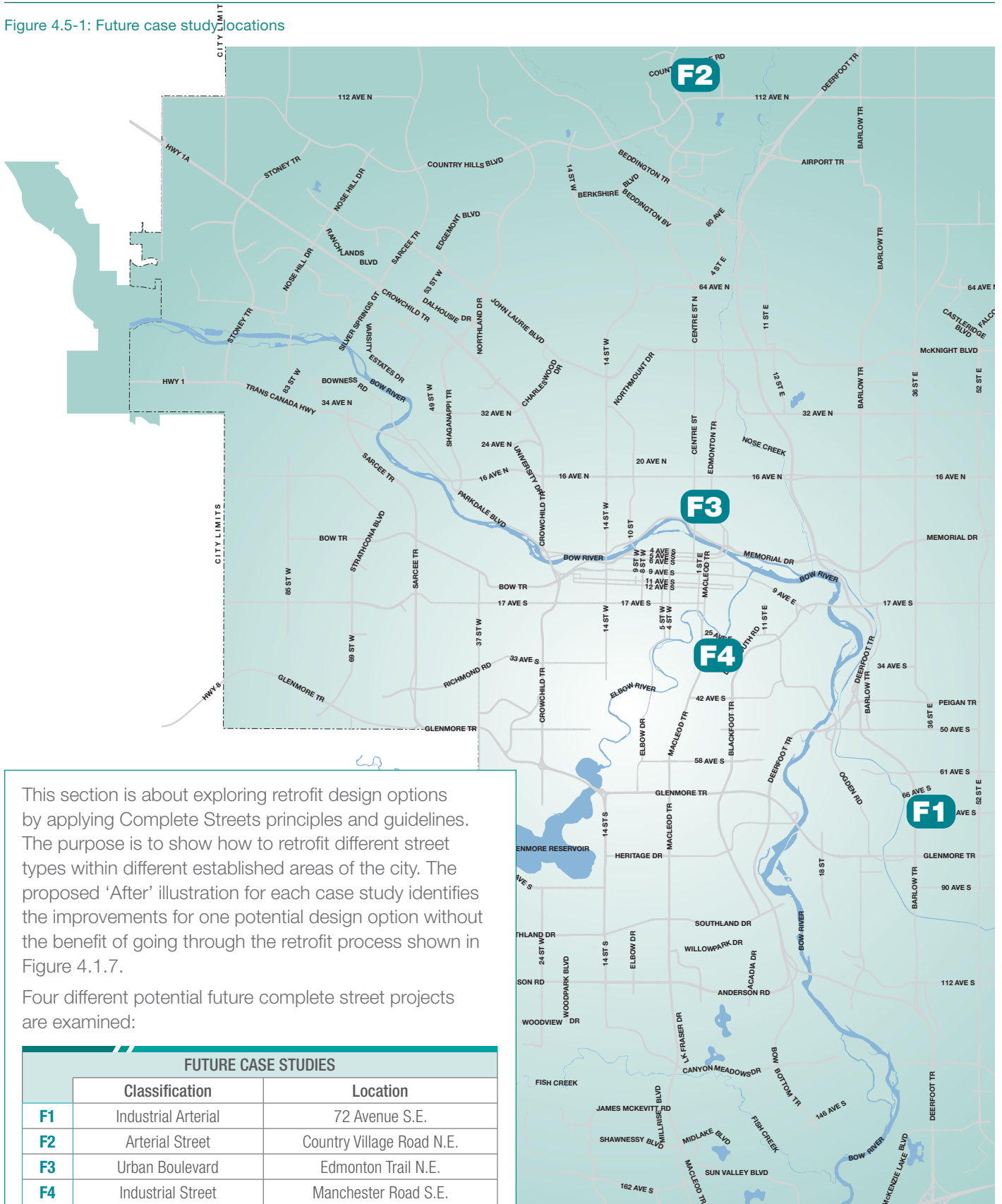

This section is about exploring retrofit design options by applying Complete Streets principles and guidelines. The purpose is to show how to retrofit different street types within different established areas of the city. The proposed ‘After’ illustration for each case study identifies the improvements for one potential design option without the benefit of going through the retrofit process shown in Figure 4.1.7.

Four different potential future complete street projects are examined:

FUTURE CASE STUDIES		
	Classification	Location
F1	Industrial Arterial	72 Avenue S.E.
F2	Arterial Street	Country Village Road N.E.
F3	Urban Boulevard	Edmonton Trail N.E.
F4	Industrial Street	Manchester Road S.E.

The locations are illustrated on the map in Figure 4.5-1.

## Future Case Study – F1

**Industrial Arterial:** 72nd Avenue S.E. (40th Street to 44th Street E.)

### Site Location/Characteristics

72nd Avenue is located in Foothills Industrial Park in southeast Calgary. As illustrated in this map, the road is surrounded by light industrial and heavy industrial land-uses and connects Barlow Trail to 52nd Street E.

The existing land use and activity characteristics along 72nd Avenue are summarized in the table below.



Site Characteristics	
Context	Different parcel size of light industrial such as storage and packaging.
Activity	Walking to meet daily needs as well as connection between buildings. Cycling to work is a possibility.
Function	Transit route, heavy truck movement.
Land Use	Industrial, retail, office, recreation, open space.
Intersections	Very wide and no consideration for pedestrian crossing.



### Before

This roadway provides two driving lanes in each direction, no on-street parking, no sidewalks, no bicycle facilities, and a poorly accessible transit stop.



### After

Complete Street improvements:

- 1 Separated multi-use pathway.
- 2 Transit stop pad, shelter and bench.
- 3 Direct access to adjacent business.

Future improvements:

- 4 Accessible ramp access to adjacent business.
- 5 Replacing overhead utilities to underground and improve multi-use pathway lighting.



**Future Case Study – F2**

**Arterial Street:** Country Village Road N.E.

**Site Location/Characteristics**

Country Village Road is situated in northeast Calgary in the community of Country Hills Village. As illustrated in this map, a large section of the road is adjacent to retail (pink), recreational (green) and City facilities (purple).



The existing land use and activity characteristics along Country Village Road are summarized in the table below.

Site Characteristics	
Context	Neighbourhood shopping centre, sports and recreation regional centre (Cardel Centre).
Activity	Shopping, walking and cycling (NAC).
Function	Vehicular movement, goods movement and transit.
Land Use	Retail, office, residential, recreation, open space.
Intersections	They are designed for car movement only, with left turns and merging islands, as well as wide radii.

**Before**

This roadway provides two driving lanes in each direction, exclusive turning lanes with a concrete median, and a sound attenuation wall.



The current roadway is incomplete. It does not have a cycling facility, transit users have no shelter from the elements, and there is a lack of street trees.



**After**

Complete Street improvements:

- 1 Sidewalk converted to multi-use pathway.
- 2 Bus shelter to protect patrons from weather.
- 3 Landscaped median with trees.
- 4 Green elements added to sound wall.
- 5 Additional bench seating.
- 6 Decorative street light treatments.

## Future Case Study – F3

**Urban Boulevard:** Edmonton Trail N.E. (6th Ave. to 8th Ave. N.)

### Site Location/Characteristics

Edmonton Trail is an existing Arterial that separates the communities of Crescent Heights and Bridgeland. It carries a significant amount of commuter traffic and has been identified as a future Urban Boulevard – a high-density mixed-landuse corridor.



The existing land use and activity characteristics along Edmonton Trail are summarized in the table below.

Site Characteristics	
Context	Shopping plazas, local restaurants, drinking establishments, multi-storey residential, medium-height buildings.
Activity	Walking, biking, shopping, jogging, eating and outdoor seating.
Function	Transit route, vehicular focus.
Land Use	Restaurants, retail, offices, residential.
Intersections	Crosswalk closure.



### Before

This roadway provides two driving lanes in each direction, no on-street parking, narrow sidewalks adjacent to travel lanes on both sides, and no bicycle facilities.



### After

Complete Street Improvements:

- 1 Sidewalk separated with decorative pavers.
- 2 Public trees introduced.
- 3 Bike lanes.
- 4 On-street treatment to expand public realm.
- 5 Street furniture.
- 6 On-street parking.

**Future Case Study – F4**

**Industrial Street:** Manchester Road S.E. (36th Ave. to 38th Ave. S.)

**Site Location/Characteristics**

Manchester Road is situated in southeast Calgary in the North Manchester Industrial area. As illustrated in this map, the road is surrounded by light industrial land-uses and sees lots of weekday vehicular activity.



The existing land use and activity characteristics along Manchester Road are summarized in the table below.

Site Characteristics	
Context	Local industrial.
Activity	Walking, biking, delivering goods and services.
Function	Goods movement.
Land Use	Local industrial area.
Intersections	Very wide to accommodate large vehicular movement.



**Before**

This roadway provides two driving lanes in each direction, parking on both sides and a large number of driveways for access to business on-site parking. The environment is very auto-oriented. There is no accommodation for pedestrians or cyclists.



**After**

Complete Street improvements:

- 1 Separate sidewalk or multi-use pathway.
- 2 Green boulevard with public trees.
- 3 Employee parking moved to rear.
- 4 Centre line added to slow traffic.
- 5 Pedestrian-scale lighting introduced.

# 5

## Chapter 5 New Street Design Standards

### 5.1 MINIMUM STANDARDS

---

During the chartering process for developing a Complete Streets Guide in 2010, the Steering Committee mandated that revised cross-sections matched existing right-of-way (ROW) requirements (+/- 10%) while including all Complete Streets elements. In most cases, the project team was able to achieve this, given the large boulevards in the existing cross-sections. Through an exhaustive collaborative approach with internal stakeholders, existing street element widths were reduced, new street elements added, and the minimum possible ROW was achieved. The main purpose of this exercise was to provide a prescriptive set of street standards that transportation engineers could apply to new street construction, and be assured that the standards are:

- inclusive of all Complete Streets elements, and
- using the minimum right-of-way requirements that the project team was able to negotiate with internal stakeholders.



## 5.2 DESIGN GUIDE FOR SUBDIVISION SERVICING

---

This non-statutory City of Calgary document (updated 2012) is a consolidation of engineering design standards that are used in the preparation of subdivision construction drawings for the construction of both surface and underground public infrastructure. It supplements the current editions of:

- Standard Specifications for Roads Construction
- Standard Specifications for Landscape Construction
- Standard Specifications for Waterworks Construction
- Standard Specifications for Sewer Construction

**Section II: Roads** includes General Information, Roadway Definitions, and Design Standards for all street classifications. This information has been revised to reflect the guidelines and principles presented in Chapter 3 of the Complete Streets Guide. At the time of writing of this

document, negotiations between The City of Calgary and the Urban Development Institute (UDI) regarding these revisions had not been completed. Once they are, the Design Guide for Subdivision Servicing will be updated with these revisions, at which time new road construction must adhere to these revised Complete Streets standards.

As with current process, an applicant can choose to submit road standards that do not conform to Complete Streets standards. However, the review, revision, and acceptance of these non-conforming standards will extend the application review time.

The latest version of the Design Guide for Subdivision Servicing can be downloaded at:  
[http://www.calgary.ca/PDA/DBA/Documents/urban\\_development/publications/design-guidelines-for-subdivision-servicing-2012.pdf](http://www.calgary.ca/PDA/DBA/Documents/urban_development/publications/design-guidelines-for-subdivision-servicing-2012.pdf)



## 5.3 REVISED STREET DESIGN STANDARDS

Figure 5.3-1: Skeletal road

Skeletal Road		
Daily Traffic Volume (vehicles)	Number of Lanes	Right-of-way Requirement
30,000 and above	4, 6 or 8	60.0 m (min)

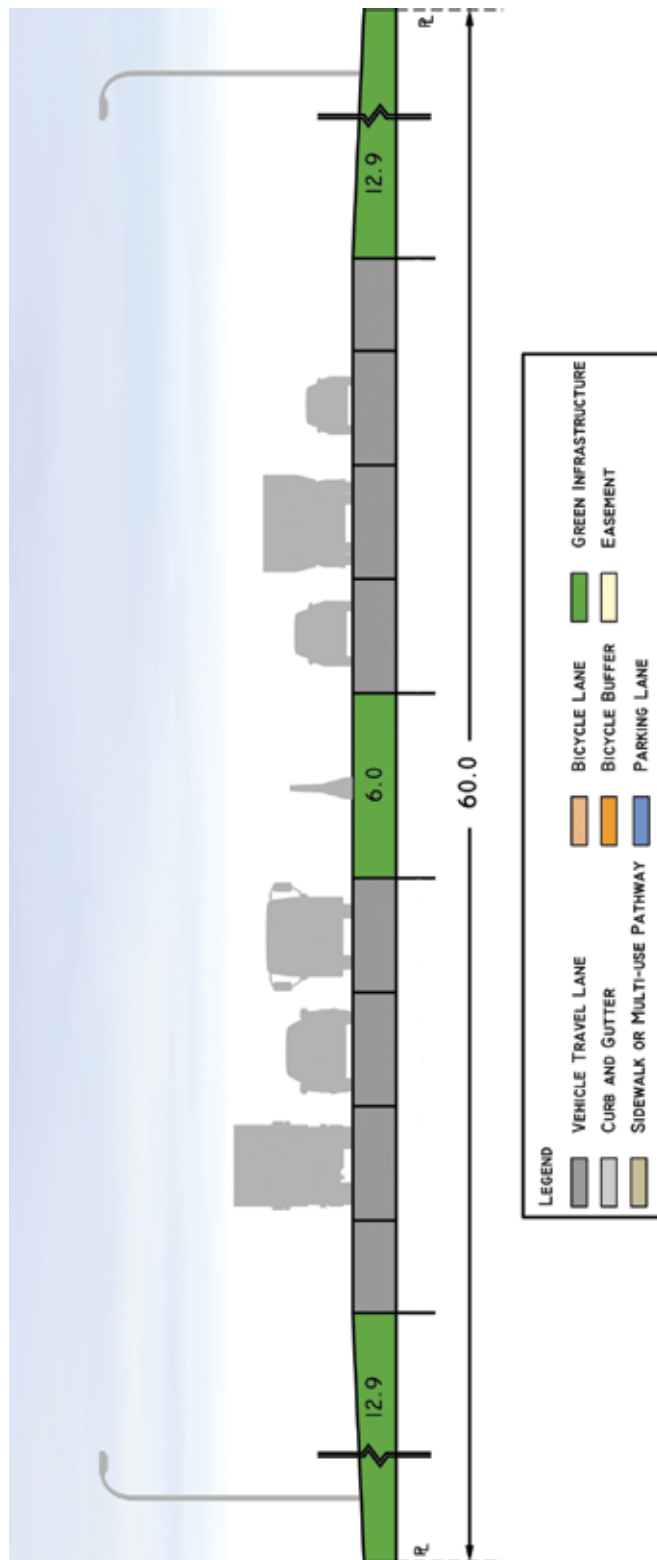

Figure 5.3-2: Arterial street

Arterial Street		
<b>Arterial Street</b>		
Daily Traffic Volume (vehicles)	Number of Lanes	Right-of-way Requirement
20,000 - 35,000	4	36.0 m (min)

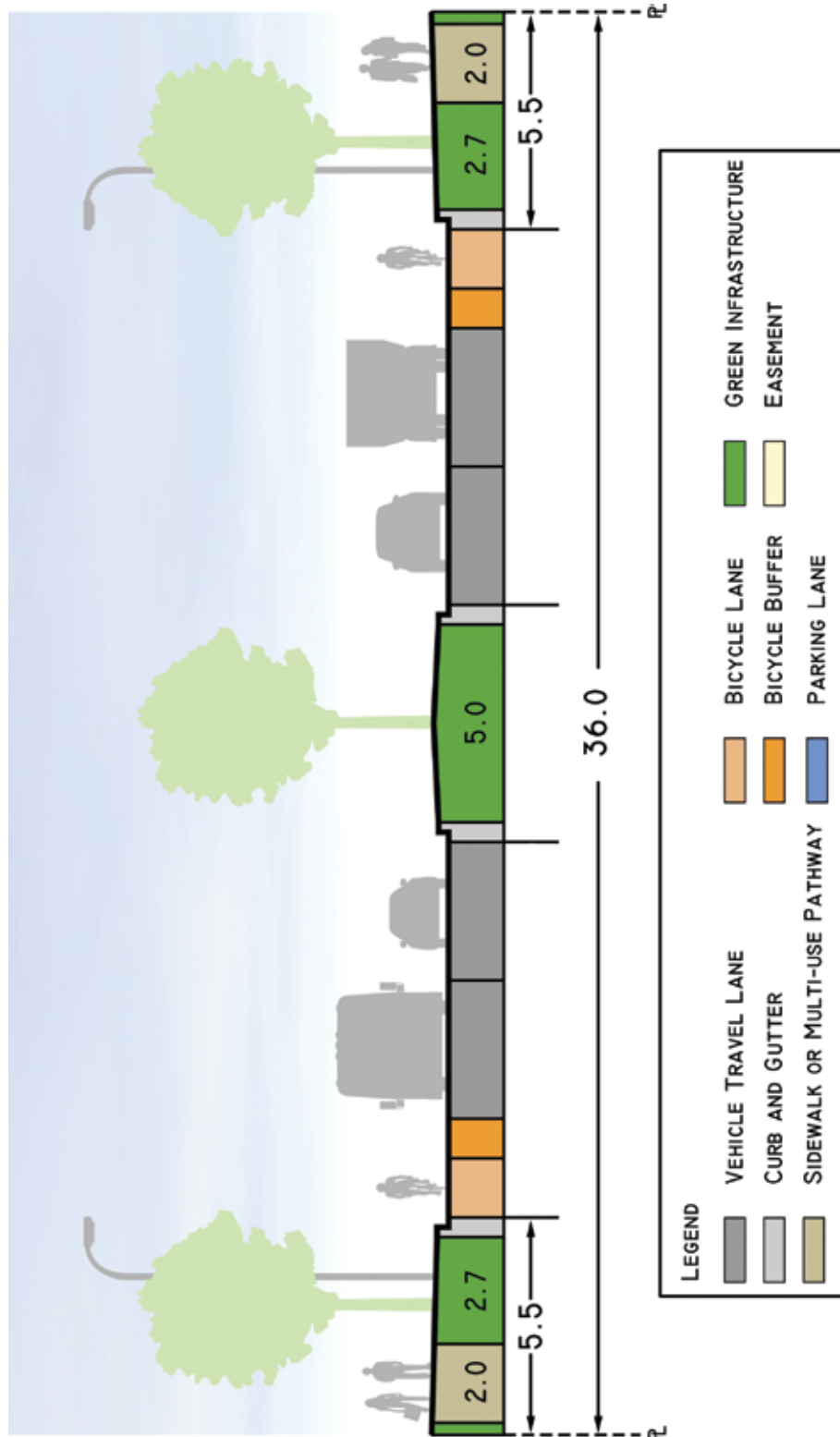

Figure 5.3-3: Industrial arterial

Arterial Street		
<b>Industrial Arterial</b>		
Daily Traffic Volume (vehicles)	Number of Lanes	Right-of-way Requirement
10,000 - 30,000	4	30.0 m (min)

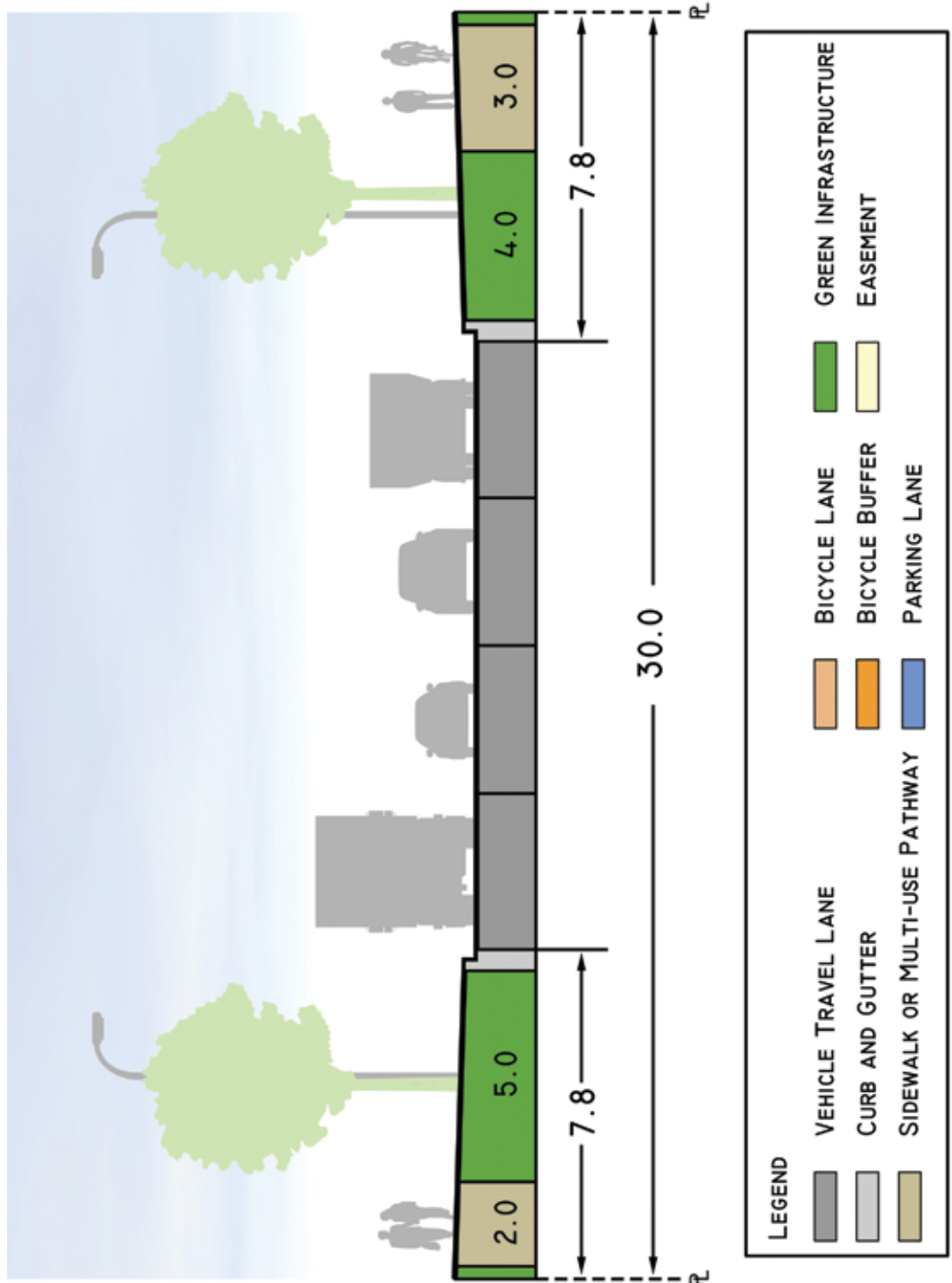

Figure 5.3-4: Local arterial street

Arterial Streets		
<b>Local Arterial</b>		
Daily Traffic Volume (vehicles)	Number of Lanes	Right-of-way Requirement
15,000 - 20,000	4	32.0 m (min)

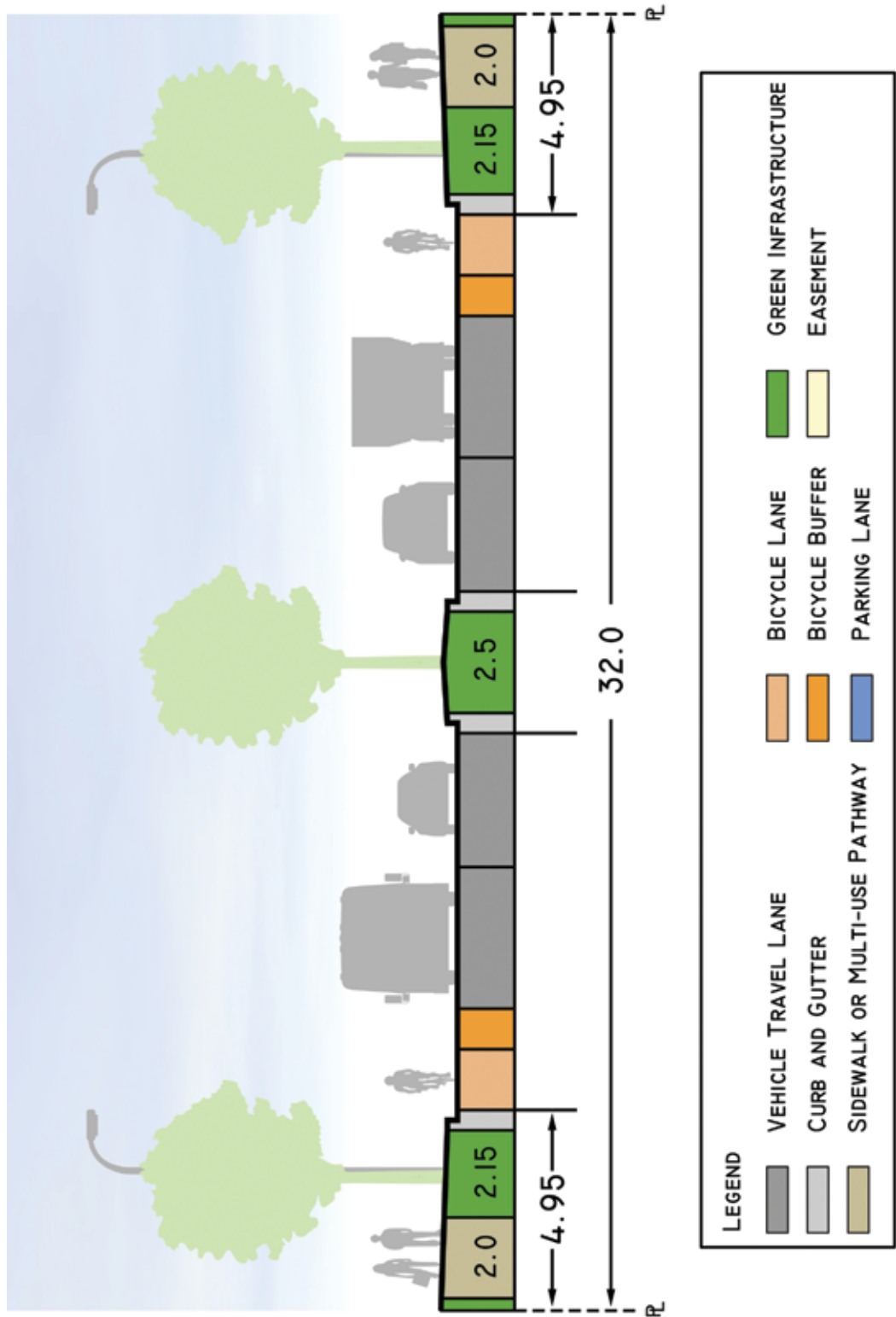

Figure 5.3-5: Urban boulevard

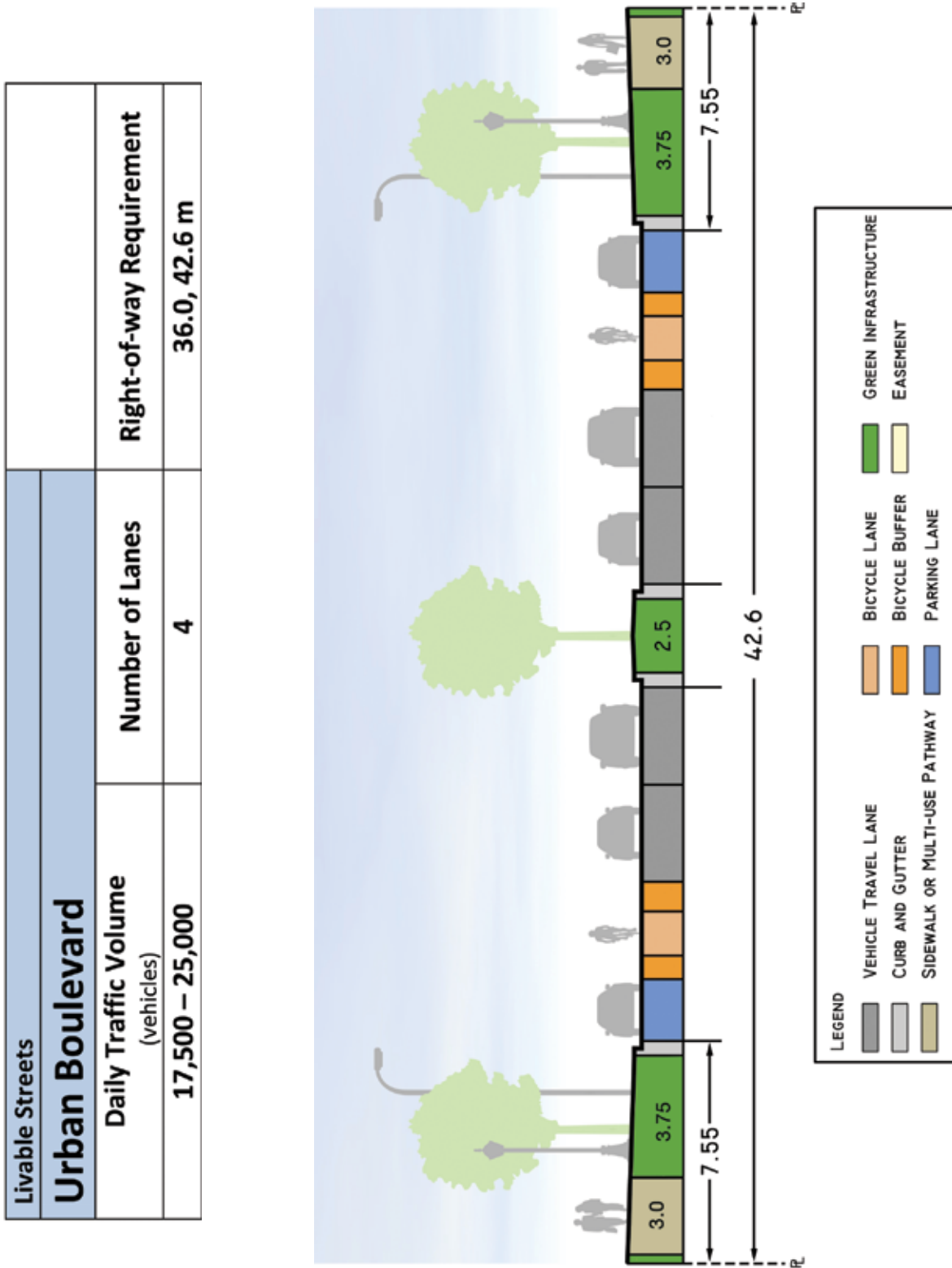



Figure 5.3-6: Parkway

Arterial Streets		
Parkway		
Daily Traffic Volume (vehicles)	Number of Lanes	Right-of-way Requirement
20,000 – 35,000	4	36.0 m

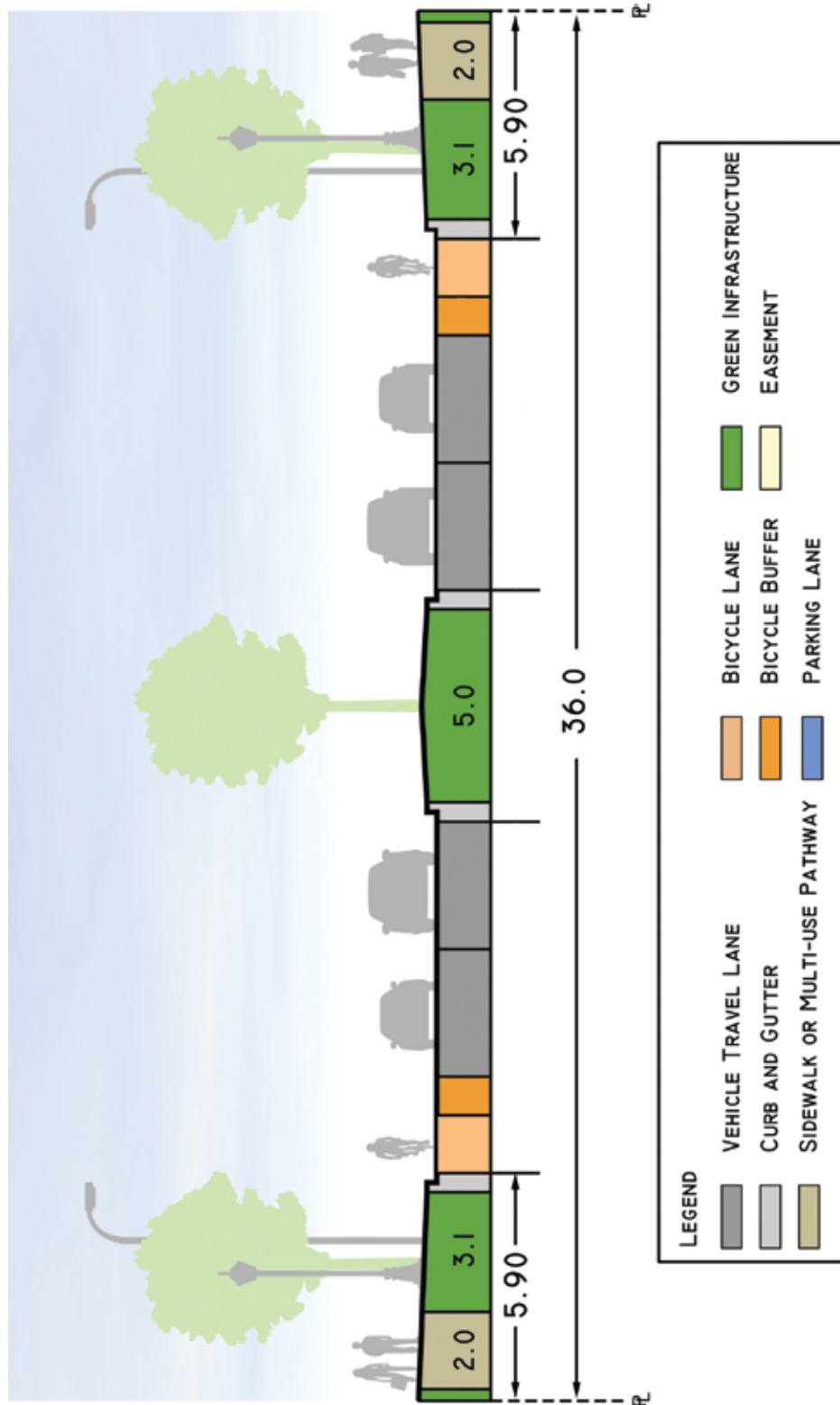

Figure 5.3-7: Neighbourhood boulevard

<b>Livable Streets</b>		
<b>Neighbourhood Boulevard</b>		
<b>Daily Traffic Volume (vehicles)</b>	<b>Number of Lanes</b>	<b>Right-of-way Requirement</b>
<b>12,500 – 22,500</b>	<b>2 or 4</b>	<b>30.0 m</b>

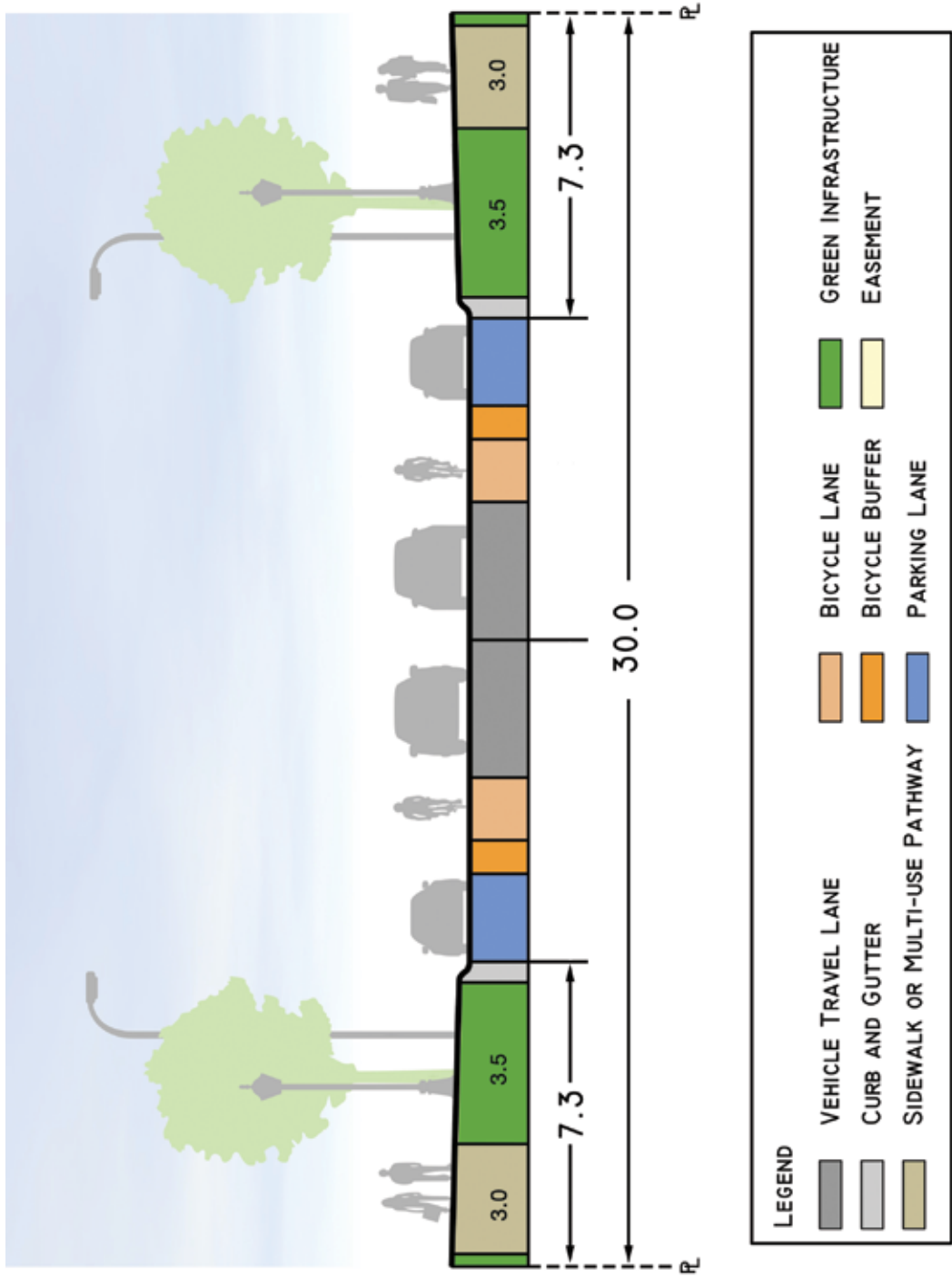

Figure 5.3-8: Primary collector

Local Street		
<b>Primary Collector</b>		
Daily Traffic Volume (vehicles)	Number of Lanes	Right-of-way Requirement
8,000 – 15,000	2 or 4	29.0 m, 30.0 m

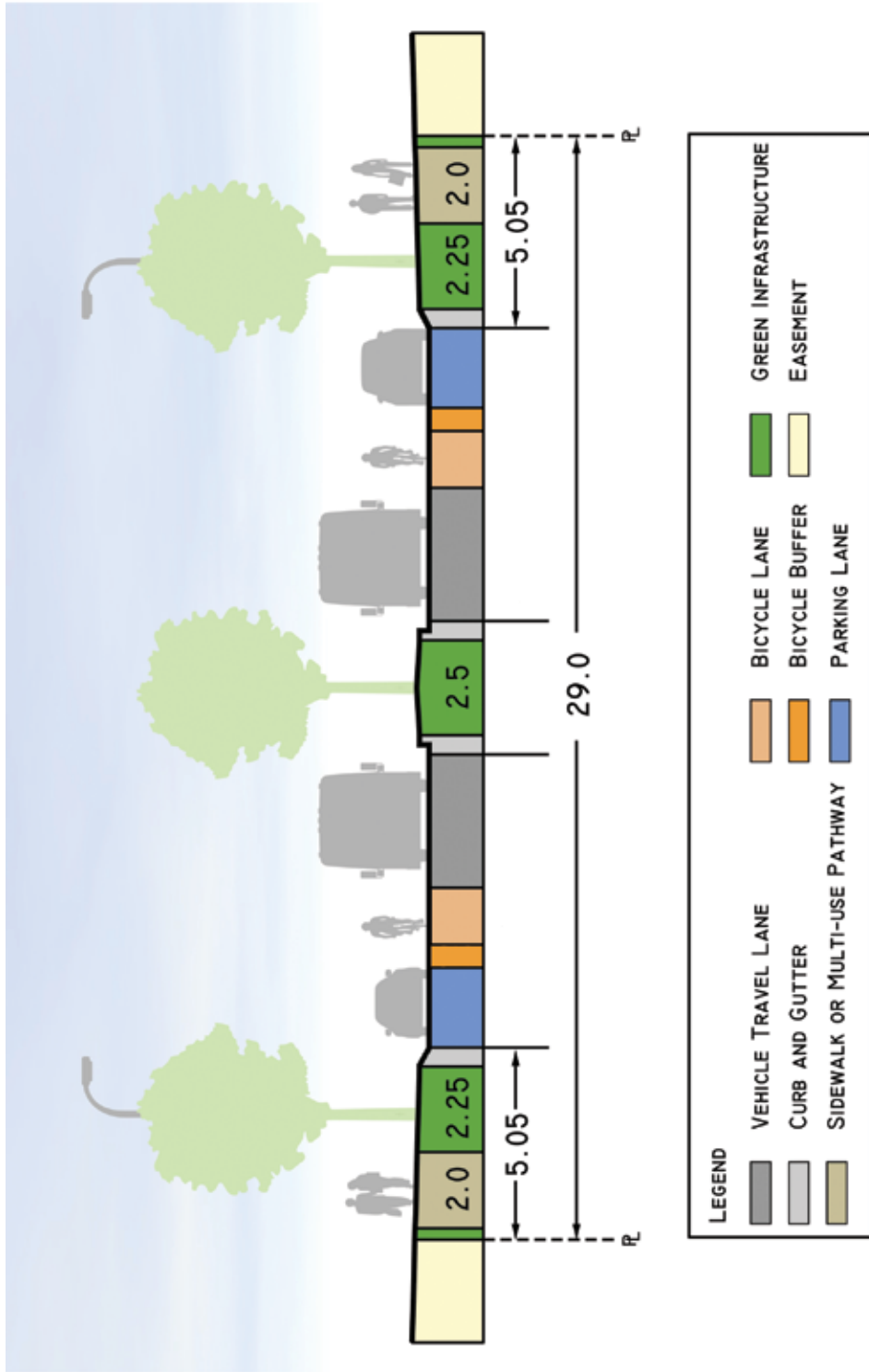
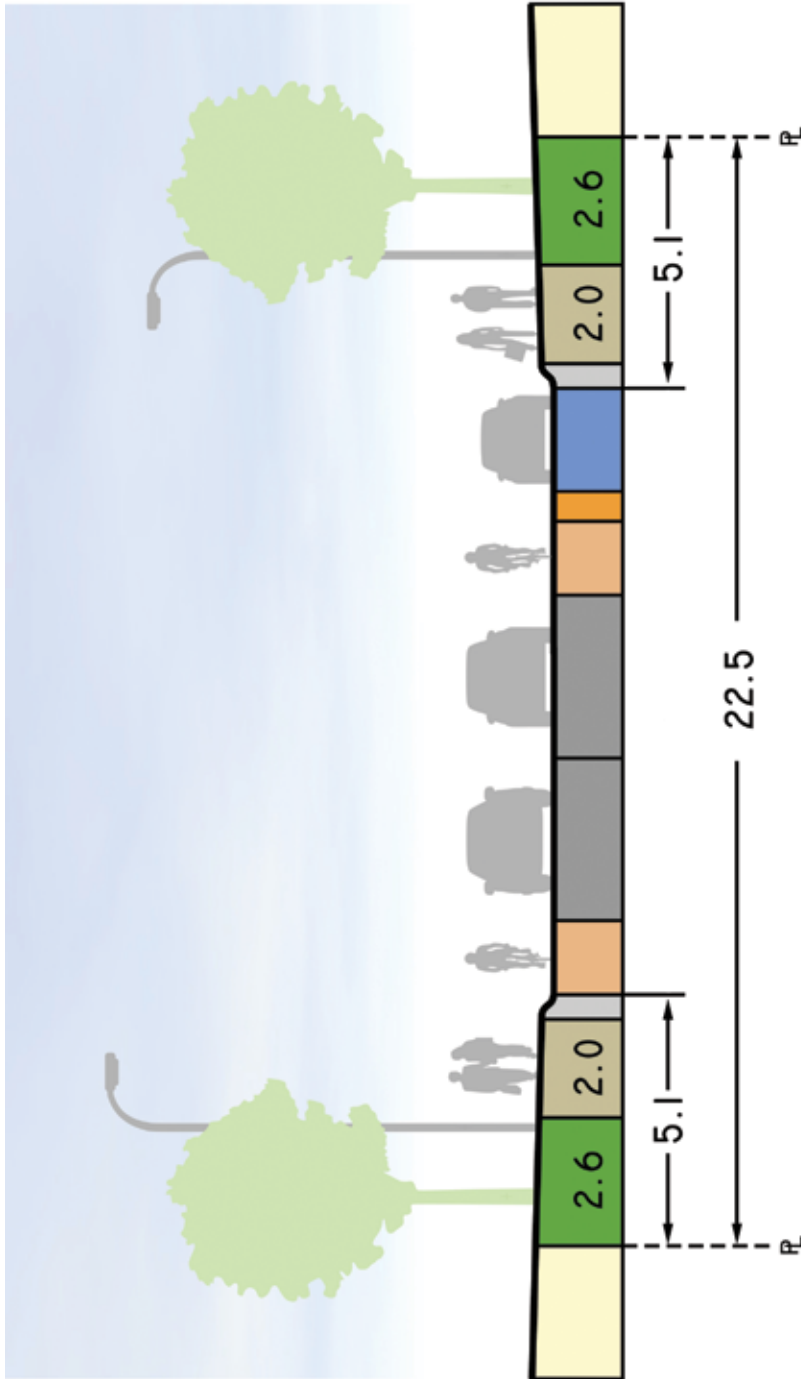

Figure 5.3-9: Collector street

Local Street		
<b>Collector Street</b>		
Daily Traffic Volume (vehicles)	Number of Lanes	Right-of-way Requirement
2,000 – 8,000	2	22.5 m



**LEGEND**

- VEHICLE TRAVEL LANE
- GREEN INFRASTRUCTURE
- BICYCLE LANE
- EASEMENT
- CURB AND GUTTER
- PARKING LANE
- SIDEWALK OR MULTI-USE PATHWAY

Figure 5.3-10: Activity centre street

Local Street		
<b>Activity Centre Street</b>		
Daily Traffic Volume (vehicles)	Number of Lanes	Right-of-way Requirement
3,000 – 15,000	2	26.0 m

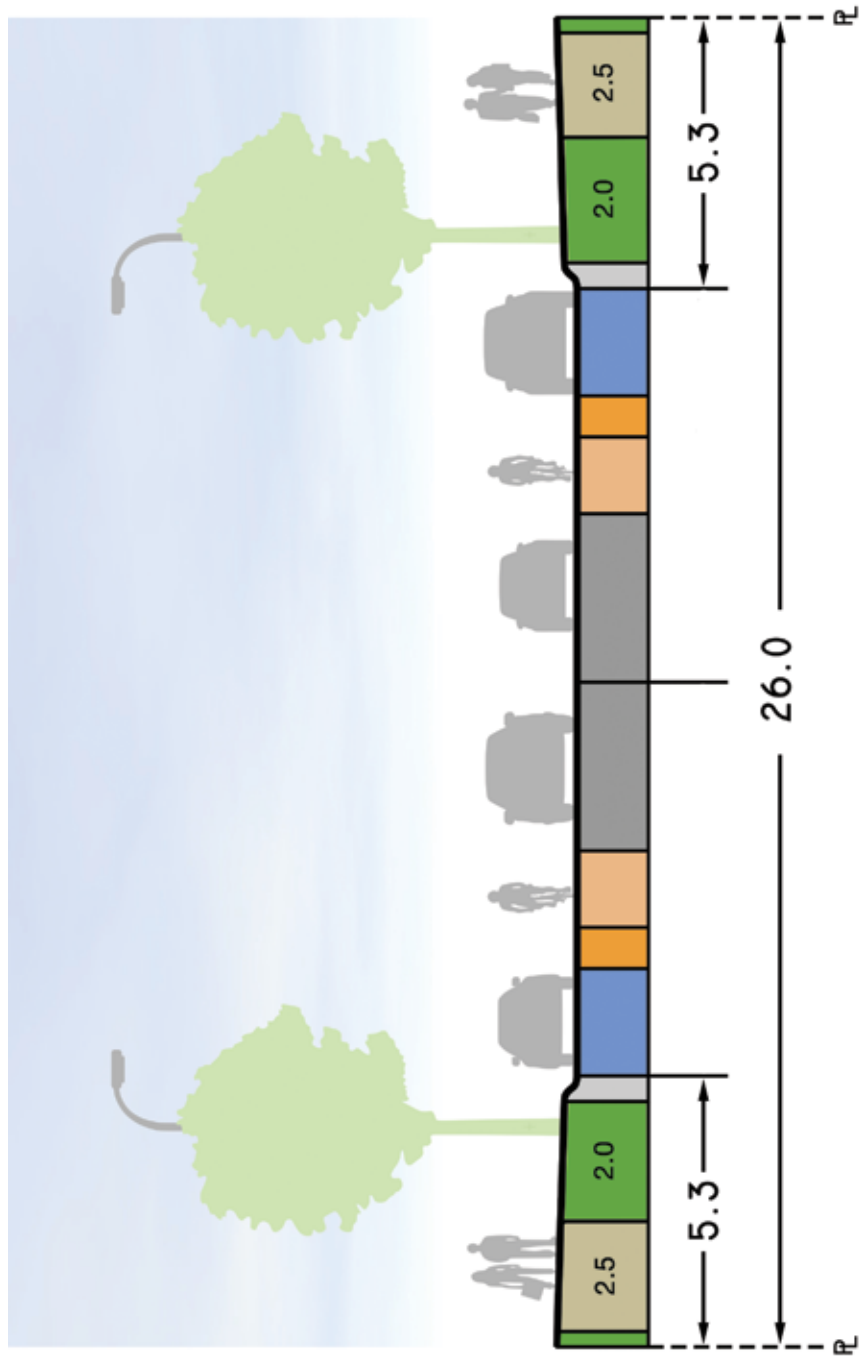

**LEGEND**

- [Grey Box] VEHICLE TRAVEL LANE
- [Green Box] GREEN INFRASTRUCTURE
- [Light Grey Box] CURB AND GUTTER
- [Orange Box] BICYCLE LANE
- [Light Yellow Box] EASEMENT
- [Dark Grey Box] SIDEWALK OR MULTI-USE PATHWAY
- [Blue Box] BICYCLE BUFFER
- [Dark Blue Box] PARKING LANE



Figure 5.3-11: Industrial street

Local Street		
<b>Industrial Street</b>		
Daily Traffic Volume (vehicles)	Number of Lanes	Right-of-way Requirement
3,000 – 12,000	2	19 m

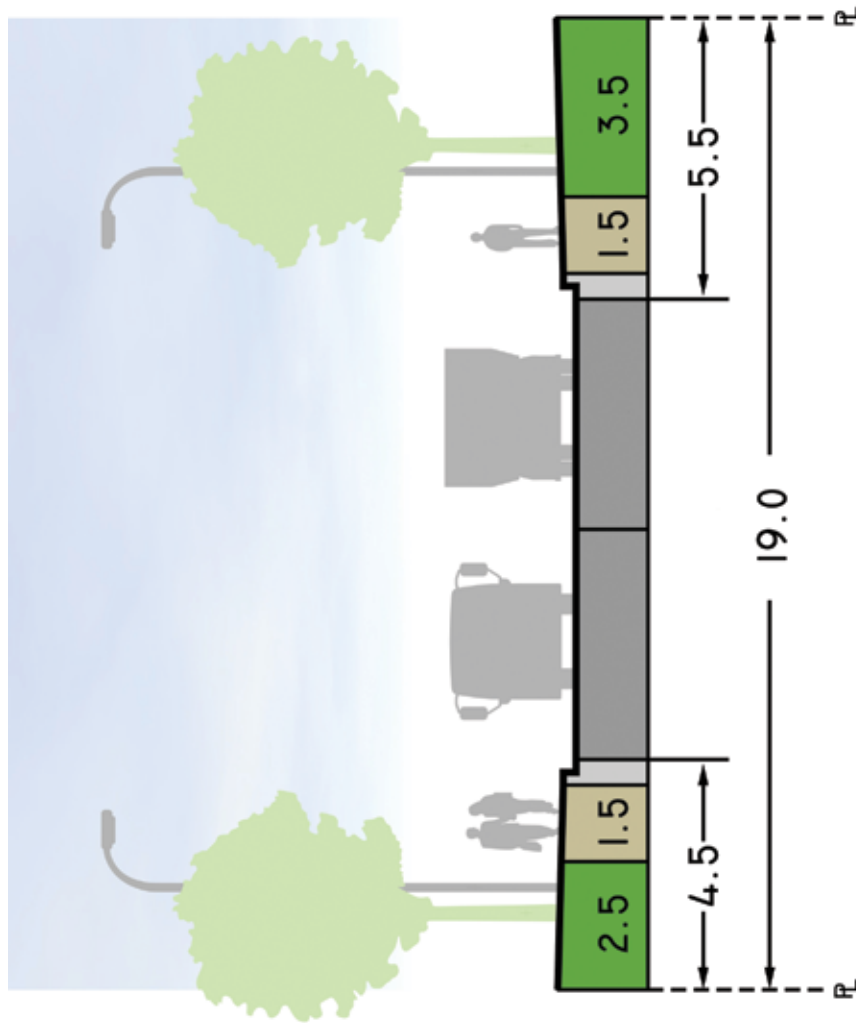

<b>LEGEND</b>	VEHICLE TRAVEL LANE	BICYCLE LANE	GREEN INFRASTRUCTURE
	CURB AND GUTTER	BICYCLE BUFFER	EASEMENT
	SIDEWALK OR MULTI-USE PATHWAY	PARKING LANE	

Figure 5.3-12: Residential street

<b>Local Streets</b>		
<b>Residential Street</b>		
Daily Traffic Volume (vehicles)	Number of Lanes	Right-of-way Requirement
< 2,000	2	16.0 m, 18.4 m

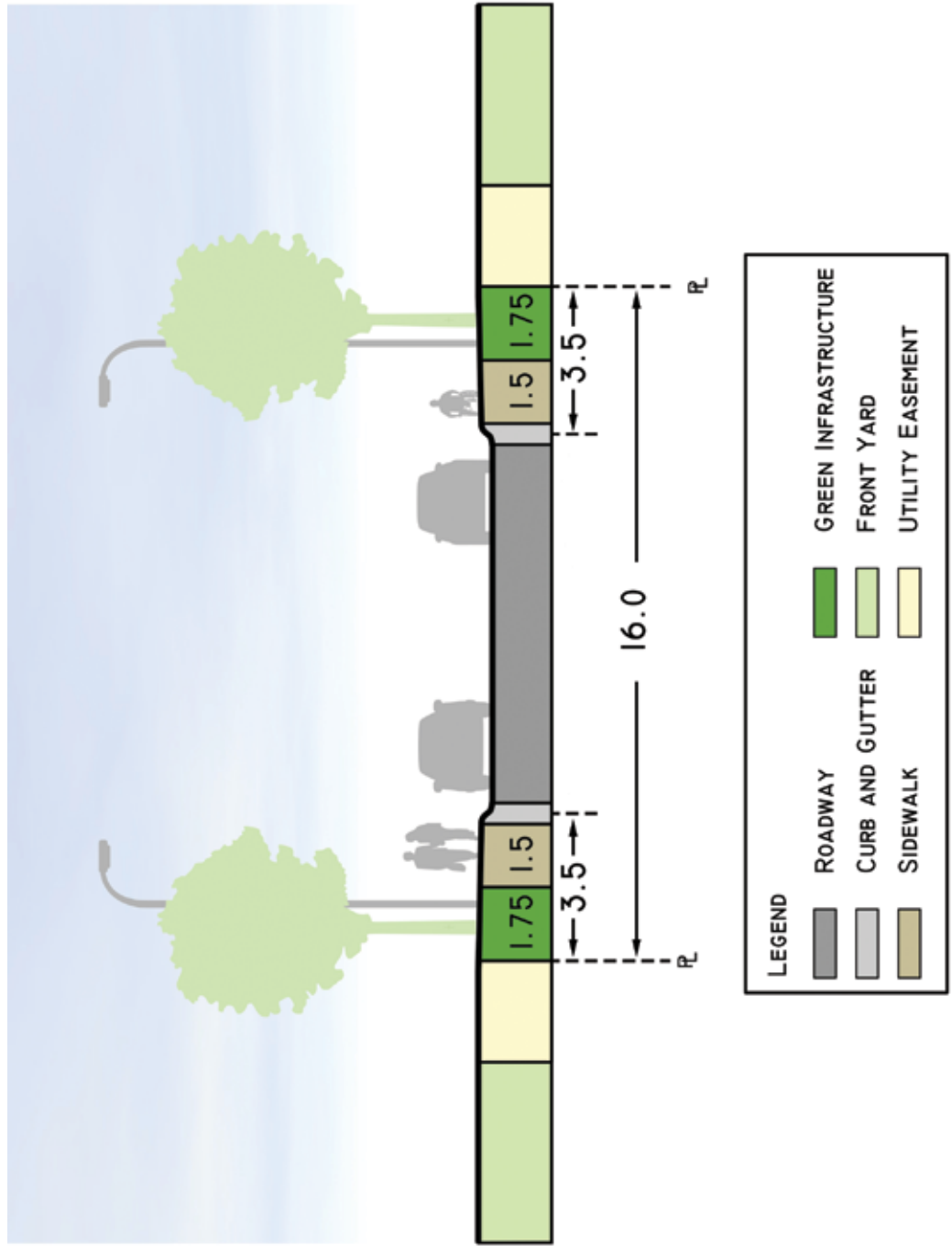
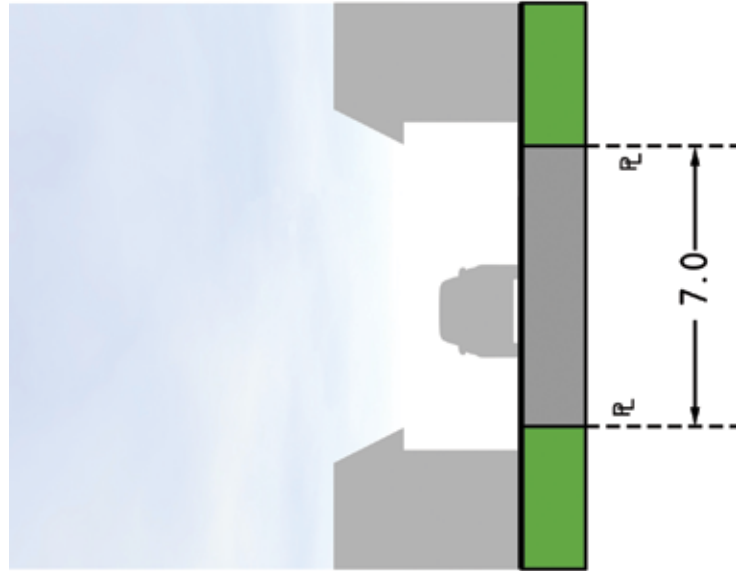

Figure 5.3-13: Lane (alley)

Local Streets		
<b>Lane (Alley)</b>		
Daily Traffic Volume (vehicles)	Number of Lanes	Right-of-way Requirement
	1	7.0 m



**LEGEND**

- VEHICLE TRAVEL LANE
- GREEN INFRASTRUCTURE
- BICYCLE LANE
- EASEMENT
- BICYCLE BUFFER
- PARKING LANE
- CURB AND GUTTER
- SIDEWALK OR MULTI-USE PATHWAY



# 6

## Chapter 6 Costs and Funding

### 6.1 NEW STREET COSTS

The revised street standards generally include more pavement width (for bicycle facilities), more sidewalk width, and less boulevard width. Underground infrastructure, streetlights, and signage are essentially the same. Table 6-1 shows the comparative costs between the existing 'incomplete' street standards and the new Complete Streets standards.

Table 6-1: Existing vs. new standard street costs (\$1,000s/km)

EXISTING vs. NEW STANDARDS STREET COSTS			
	Existing	New	Difference
Arterial	3,330	3,720	+11.7%
Industrial Arterial	2,920	3,030	+3.8%
Local Arterial	2,930	3,150	+7.5%
Urban Boulevard	–	4,400	–
Parkway	–	3,760	–
Neighbourhood Boulevard	–	3,280	–
Primary Collector	3,060	3,320	+8.5%
Collector	1,880	2,040	+8.5%
Activity Centre Street	–	2,340	–
Industrial Street	1,760	1,740	-1%
Residential Street	1,135	1,250	+10%
Lane (Alley)	360	320	-12%

The cost of construction of the revised new street standards is, on the average, about 10% higher due to additional pavement for on-street bike facilities and additional concrete for increased sidewalk width.



## 6.2 RETROFIT STREET COSTS

Reconstruction (or retrofit of existing streets) costs can vary greatly. Costs depend greatly on the extent of public realm improvements, additional trees, low impact development features, and the complexity of existing underground utility relocations. The funding strategies for these retrofit streets are discussed below in section 6.3.

## 6.3 FUNDING STRATEGIES

### New Streets (Greenfield Areas):

The developer typically constructs community streets, so there is no impact on capital budget to the City.

As there are higher costs associated with the new street standards, the Oversized Levy Agreement with the Urban Development Industry will be renegotiated in conjunction with the revised detailed design standards (DGSS) after the Complete Streets Policy and Guide is approved by Council.

### 6.3.1 Increase Municipal Funding to Mobility Corridor Projects and Programs

The Council approved Investing in Mobility (2015-2024 Transportation Infrastructure Investment Plan) proposes allocation of 40% (or \$2.2 billion) of the estimated \$5.6 billion required for Transportation infrastructure projects and programs over the next 10 years toward mobility hub and transit corridor projects and programs. The majority of complete streets with an enhanced public realm are situated within the mobility hubs and corridors, so the allocation of funds is aligned to implement Complete Streets.

#### Future concept of 17th Avenue S.W. – Urban Boulevard



In addition, the plan also recommended 25-30% (or 1.5 billion) of the estimated \$5.6 billion required for transportation infrastructure projects and programs over the next 10 years toward life-cycle/maintenance requirements, including activity centres and corridors where most of these higher quality streets are situated. Parks and Water Resources will require additional operating budget for the life-cycle/maintenance of green infrastructure and low impact development features within the public right-of-way.

#### Pathway



#### Pedestrian bridge



#### Tree grate



### **6.3.2 Revised Project Design Process**

Savings can be realized by integrating multi-modal facilities into early project design phases which folds costs for these enhancements into the costs for the overall project.

### **6.3.3 Establish Business Revitalization Zones**

A Business Revitalization Zone (BRZ) is a self-help program by which businesses in an area can jointly raise and administer funds to improve and promote their businesses. The City has 10 established BRZs. There has been more than \$14 million in BRZ direct contributions to streetscape improvements through local improvement bylaws or direct spending since 1983.

In special circumstances (Stephen Avenue Mall, for example) The City may enter into a cost-sharing agreement with a BRZ for lifecycle/maintenance costs.

### **6.3.4 Calgary Municipal Land Corporation (CMLC)**

Calgary Municipal Land Corporation (CMLC) , created by Calgary City Council in 2007, to lead the Rivers District Community Revitalization Plan - a public infrastructure program approved by the City of Calgary and the Province of Alberta. CMLC was granted a \$283.5 million budget to pursue the mandate through strategic investments in infrastructure towards the Rivers District Community Revitalization Plan.



# 7

## Chapter 7 Implementation Strategy

### 7.1 STANDARDS AND SPECIFICATIONS

---

A successful Complete Streets Program requires four key components:

1. Complete Streets Policy
2. Complete Streets Guide
3. Revised Standards and Processes
4. Education

Building on the high level policies of the Calgary Transportation Plan (CTP) a Complete Streets Policy (of which this Guide is a part) has been created. This document completes the second component of the program. The third and most critical component, Revised Standards and Processes, is well underway. Revisions for the Design Guide for Subdivision Servicing (DGSS) is complete (see Chapter 5). The DGSS supplements, but does not replace, the more specific details contained in these City of Calgary specification documents:

- Standard Specifications for Roads Construction
- Standard Specifications for Landscape Construction
- Standard Specifications for Waterworks Construction

Revision of several drawings and creation of new drawings are required to align with the Complete Streets Guide and the revised standards in the Design Guide for Subdivision Servicing.

***It will be incumbent upon the respective departments to ensure their standard specifications are updated in 2015.***

## 7.2 BYLAWS AND POLICY

### RESIDENTIAL STREET DESIGN POLICY (TP-018)

#### Status: Currently being implemented

After 10 years of work by City Administration, Council unanimously approved Policy TP-018: Residential Street Design Policy in November 2012. The Policy directs Administration and the development industry to apply new residential street standards that provide for tree-lined streets and wider sidewalks on both sides. The policy replaces the existing Residential Street Standard that did not provide for trees near the street nor wider sidewalks on both sides of the street. This new standard makes the residential street “complete.” The Policy can be found online at [www.calgary.ca](http://www.calgary.ca).

### ENVIRONMENTAL CAPACITY GUIDELINE POLICY (TP-009)

#### Status: To be replaced by Street Capacity Guidelines

The 1979 Policy (amended in 2003) places limitations to the daily traffic volumes on local street classifications. These limitations are a barrier to the objectives of the CTP and MDP: to accommodate half of our future population growth within the existing city boundaries. To achieve this, street traffic volumes may exceed these thresholds, near activity nodes and corridors. The Street Capacity Guidelines provide revised thresholds for daily traffic volumes for all Street classifications, not just local streets.

### LAND USE BYLAW

#### Status: Future Implementations Action

Revisions are required to the Land Use Bylaw before it will align with the Complete Streets Program. In particular, Part 3, Division 1, Table 1: Road ROWs will need to be revised. The table has not been revised to reflect the new street types reflected on the CTP Road and Street Network. In many cases, additional ROW will be required for those corridors identified as part of a Primary Network, or a Neighbourhood or Urban Boulevard.

### CALGARY TRANSPORTATION PLAN (TP-012)

#### Status: Future Implementations Action

Amendments are required to the CTP before it will align with the content of this Guide. For example, Figure 3 – Road and Street Palette, Section 3.7 CTP needs to be replaced by Figure 1-3, 2013 Complete Streets Guide as this has been expanded to include ALL street classifications.

## 7.3 PROCESSES

### 7.3.1 Policy Document Development

The Local Area Planning Implementation (LPI) and City Wide Policy and Integration (CPI) business units lead the development of these policies in collaboration with other business units, including Transportation Planning:

- Regional Context Studies (e.g., South Shaganappi RCS)
- Area Structure Plans (e.g., West Macleod ASP)
- Area Redevelopment Plans (e.g., Sunalta ARP)
- Station Area Plans (e.g., Chinook SAP)
- Special Policy Areas

*Within these policy documents, it's important that streets that fall under the “Liveable” classification are identified on transportation network figures, and that Complete Streets language and policy are incorporated.* This change is already taking place.

### 7.3.2 Development Application Review

The Corporate Planning & Applications Group (CPAG) of the Development and Building Approvals Business Unit receives, reviews, conditions, and approves over two thousand (2000) development submissions each year. Submissions include:

- Outline Plan & Land Use applications;
- Stand-Alone Land Use Amendment applications;
- Road Closure applications;
- Subdivision (Tentative Plan) applications, and
- Development Permits

*CTP policy and Complete Streets guidelines have an impact on all of these submissions because they involve establishing street cross-section, street ROW width, and intersection or access locations.*

### OUTLINE PLAN AND LAND USE APPLICATIONS

Outline plans articulate the vision for a community. They show the street, intersections, access points, development parcels (and associated land use), and open space for a new community. If policy guidance doesn't exist in the Area Structure Plan (ASP) governing the area, then the Outline Plan/Land Use application is the first opportunity to identify streets that need to be given special attention (e.g., those within activity nodes and corridors). It is important that all streets within an Outline Plan are classified appropriately based on their intended function and surrounding land use context. The CTP Maps (Appendix B) and the Revised Road and Street Palette (Chapter 1.4) will assist in determining the function and land use context of a street. This determination should occur as early in the application



review process as possible. Typically, this would be the (non-mandatory) pre-application meeting with the applicant team. All proposed streets should conform to the cross-sections in the latest Design Guide for Subdivision Servicing.

***Street design details (full street right-of-way, pavement width, sidewalk width, utility locations) will need to be determined at this Outline Plan stage.***

#### **STAND-ALONE LAND USE AMENDMENT APPLICATIONS**

Stand-Alone Land Use amendment applications are made when there is a desire to change the land use designation of a single parcel of land to accommodate a particular development type. ***During the review of this type of application, there is opportunity to ensure that right-of-way set-back is preserved for the future design of the adjacent street.*** If known, this is also an appropriate time to examine access considerations that can be conditioned at the Development Permit stage.

#### **ROAD CLOSURE APPLICATIONS**

*Road closure applications are typically submitted when there is a desire to consolidate unused public road ROW with an adjacent parcel of land. **This is an opportunity for the CPAG review team to ensure that publicly owned land for potential pedestrian connections, bicycle connections, and/or linear park space remains in the City's inventory.***

#### **SUBDIVISION/TENTATIVE PLANS**

Subdivision plans provide the technical and legal details necessary to construct streets, utilities, buildings, and parks. All proposed streets should be designed to match the cross-sections presented in Chapter 5. Cross-section details are in the latest DGSS.

#### **DEVELOPMENT PERMITS**

Development Permits provide the concept of how a building or group of buildings are to be developed on a site. By this application stage, the details of the adjacent street are generally established, though inner city redevelopment may present an opportunity to revise the details of adjacent streets. In either case, details such as building set-back, street access, and site design for pedestrians will require review. Minimizing driveway accesses that cross pedestrian corridors is one of many methods of ensuring a development permit is aligned with CTP policies and Complete Streets Guide.

### **7.3.3 Transportation Projects**

Transportation projects vary greatly in scale and scope. They can, however, be categorized into three main groups: Major Infrastructure Projects (e.g., interchanges, LRT extensions), Planning Projects (e.g., 17th Avenue S.E. corridor review), and Operational Projects (e.g., wheelchair ramp installation).

#### **MAJOR INFRASTRUCTURE PROJECTS**

Major transportation infrastructure projects are typically planned, designed and constructed by Transportation Infrastructure. Projects can include street and interchange construction, pedestrian overpass construction, or LRT track and station construction. Traditionally, the planning, design and construction of these projects has revolved around the automobile with facilities for pedestrians and cyclists as a secondary consideration. This Guide aims to include these other users (or stakeholders) in the early planning stage of these projects.

#### **PLANNING PROJECTS**

Planning projects (e.g., corridor revitalizations) are typically either led by Transportation Planning or Local Area Planning Implementation (LPI) and City Wide Policy and Integration (CPI). In the past, the department not leading the project was often unaware of the project and was not able to provide their input early enough to affect its outcome. This is problematic in that land use and mobility issues are not considered concurrently and the final product falls short in one area or the other. The new approach is for both departments to meet early in the project, agree on a vision and desired outcome, and agree as to who is to lead.

Another area of "Planning" projects is our pathway system. As Parks owns and maintains our pathway system, it's important that Transportation works closely with them to identify missing links in the pedestrian and cycling network.

**OPERATIONAL PROJECTS**

Several divisions within the Roads Business Unit undertake many small scale transportation projects annually. Transportation Planning prioritizes and plans these projects, and engages the affected stakeholders. These projects include:

- Various street improvements (sidewalks, curbs);
- Wheelchair ramp installations;
- Industrial sidewalks;
- Local improvements (e.g. sidewalk replacement, lane paving);
- Development access;
- Community traffic improvements, including traffic calming measures;
- Pedestrian/bike improvements (e.g., Brentwood/University of Calgary area);
- Streetscape improvements;
- Optimization projects to improve operation of all modes; and
- Safety countermeasures for all modes.

There has been steady progress to include facilities for all users in the planning, design, and construction of these projects.

**7.3.4 Maintenance Program**

The Maintenance and Traffic Division of Roads has several maintenance programs, including:

**Maintenance Division:**

- Street resurfacing/reconstruction
- Street sweeping
- Bridge rehabilitation
- Snow and ice control

**Traffic Division:**

- Detours
- Signals
- Street signs
- Pavement markings

These existing maintenance programs can be improved to better align with Complete Streets. For example, a street resurfacing (or overlay) project presents an opportunity to implement a road diet or introduce bicycle lanes by redesigning the road marking plans. Another example is revising the snow and ice control program (including the securing of additional funding) to ensure bike lanes and sidewalks in Activity Centres are cleared of snow and ice during the winter months.

**7.4 MONITORING**

**7.4.1 Indicators and Targets**

**CORE INDICATORS FOR LAND USE AND MOBILITY**

To evaluate progress toward the policy direction of the MDP and CTP, 14 Core Indicators and Targets have been developed to direct change in density, land use mix, multi-modal transportation, and environmental sustainability. Each indicator has a 60-year target and emphasizes the critical link between land use and transportation that must be managed carefully in order to achieve the Plan It Calgary vision. Movement towards the 60-year targets of the Core Indicators will enable implementation of the full complement of MDP and CTP policies. The Core Indicator most relevant to Complete Streets is Indicator #6: Road and Street Infrastructure, and the metric is the Roads to Streets Ratio (Figure 6, Part 4, CTP). This Ratio is summarized at the 2005, 2012 and MDP/CTP target horizons in the chart below:

Figure 7-1: Roads to streets ratio

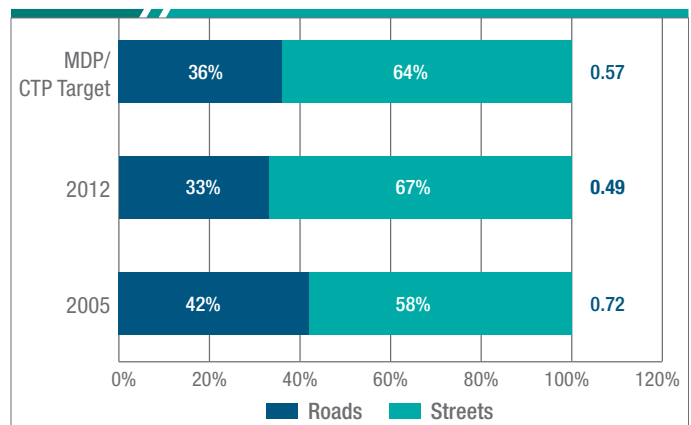

As the chart illustrates, the 2012 roads to streets ratio exceeded the MDP/CTP 60-year target. This was achieved through roadway reclassifications. The MDP/CTP target therefore needs to be updated to reflect new roadway classification decisions contained within recently approved Area Structure Plans that are currently not included in the target.

Many streets and roads still require investments to achieve the functionality defined in the MDP/CTP and this Complete Streets Guide.

This Core Indicator may be replaced with a Complete Streets Implementation indicator to steer future investment decisions toward the CTP Road and Street Network vision.

## CITY-WIDE SUPPLEMENTARY INDICATORS FOR LAND USE AND MOBILITY

While the Core Indicators link to the general themes of the MDP and CTP, a set of Supplementary Indicators for Land Use and Mobility (Supplementary Indicators) links to the objectives and policies of the MDP and CTP. Further, the Supplementary Indicators measure impacts that will often occur within a shorter time period than the Core Indicators, allowing for more timely analysis of trends and changes within the city. There is currently a Supplementary Indicator for Complete Streets Implementation (SI-25x). Using Map 7, CTP: Road and Street Network, 60-year targets were set for the three Liveable Street classifications:

- Parkways: 42 km
- Urban Boulevards: 49 km
- Neighbourhood Boulevards: 34 km

To establish a baseline for each street classification, it was necessary to develop a Complete Streets scoring tool to determine whether or not a current street could be considered “Complete.” Not surprisingly, the baselines for all three street classifications were found to be very low (i.e., less than 2 km for each).

### 7.4.2 Complete Streets Scoring Tool

Using the definitions of the new street types within the CTP, a qualitative scoring tool was developed to assess the “completeness” of a particular roadway. There are two main elements to this tool:

1. A 0 (low) to 100 (high) rating of the quality of a facility for a particular mode.
2. A 0 (low) to 1.0 (high) weighting of the facility based on the level of accommodation of a particular mode as stipulated by Figure 3, CTP: Road and Street Palette.

For example, an Urban Boulevard that has 3.0 m sidewalks or 3.5 m pathways on both sides might get a rating of 80/100 for pedestrian mode. As accommodation of pedestrians on an Urban Boulevard is to be “high,” weighting might be 0.25 (cycling 0.25, transit 0.25, goods 0.13, autos 0.12). This yields a score of 20/25 for pedestrians. Adding the score for the other modes will yield a score/100. If this score exceeds 70, then this street section is considered to be “Complete.”

Understanding how to determine when a street is “Complete,” we can now monitor the Complete Streets implementation supplementary indicator by annually adding the number of kilometres of streets that meet the 70/100 threshold.

For sample calculations, see Appendix C.

## 7.5 EDUCATION

An education plan, as identified by the U.S. National Complete Streets Coalition, is one of four key elements to a successful Complete Streets program. A written plan is required to educate City Administration, the development industry, and technical consultants on how to use the Guide. The plan could include development of web-based and/or hardcopy educational materials, presentations, workshops, outreach programs, etc.

## 7.6 IMPLEMENTATION ACTIONS

In addition to a number of actions, being completed in 2014, the short-term actions need to be undertaken to successfully implement the Complete Streets Guide.

### COMPLETED ACTIONS

1. Residential Street Design Policy (Q4 2012)
2. Finalize Complete Streets Guide (Q2 2014)
3. Complete Streets Policy & Guide Report/Recommendations to Council (Q4 2014)
4. Street Capacity Guidelines Report/Recommendations to Council (Q4 2014)
5. Update Design Guide for Subdivision Servicing (Q4 2014)

### SHORT-TERM ACTIONS

6. Form a “Complete Streets Implementation Working Group” (Q4 2014)
7. Revise Oversize Levy Agreement (Q1 2015)
8. Establish an Education Program (2015)
9. Establish a Complete Streets Monitoring Program (2015)



# Appendices

## APPENDIX A

---

### **Other Future Case Studies**

For illustrative purposes only, an additional 11 streets throughout the city were selected as candidates for retrofitting from existing quality to a Complete Street quality. These 11 locations (F5 through F15) are shown in Figure A-1 on the following page.



OTHER FUTURE CASE STUDIES

Figure A-1: Other future case study locations

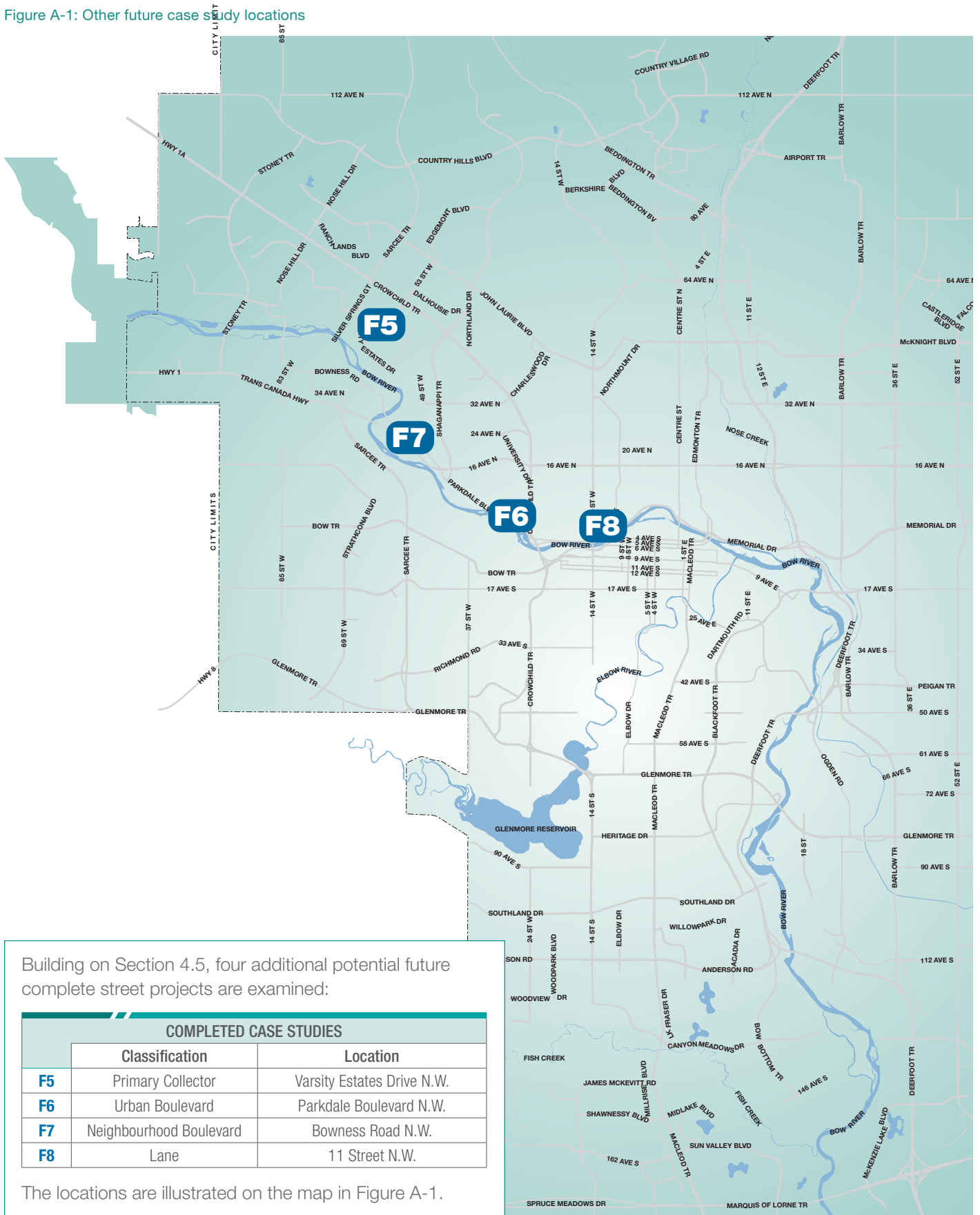

Building on Section 4.5, four additional potential future complete street projects are examined:

COMPLETED CASE STUDIES		
	Classification	Location
<b>F5</b>	Primary Collector	Varsity Estates Drive N.W.
<b>F6</b>	Urban Boulevard	Parkdale Boulevard N.W.
<b>F7</b>	Neighbourhood Boulevard	Bowness Road N.W.
<b>F8</b>	Lane	11 Street N.W.

The locations are illustrated on the map in Figure A-1.

## Future Case Study – F5

Primary Collector: Varsity Estates Drive N.W.

### Site Location/Characteristics

Varsity Estates Drive is situated in northwest Calgary in the heart of the community of Varsity Estates. As illustrated in this map, the road is surrounded by single-family residential and a golf course.

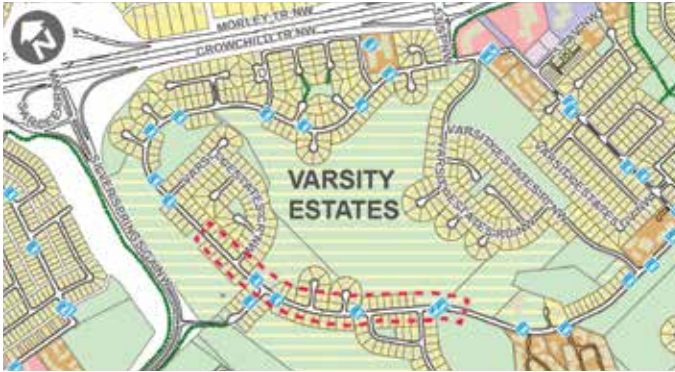

The existing land use and activity characteristics along Varsity Estates Drive are summarized in the table below.

Site Characteristics	
Context	Single detached dwellings and open spaces.
Activity	Walking, biking, jogging, recreation.
Function	Transit and car movement.
Land Use	Residential and recreation.
Intersections	Pedestrian friendly.



### Before

This roadway provides two driving lanes in each direction, no observed on-street parking on both side, no sidewalks and no bicycle facilities.



### After

Complete Street improvements:

- 1 Wide sidewalk.
- 2 Painted on-street bike lanes.
- 3 On-street parking (helps to calm traffic).

**Future Case Study – F6**

**Urban Boulevard:** Parkdale Boulevard N.W. (between 32nd Street and 34A Street)

**Site Location/Characteristics**

As shown in the site plan below, Parkdale Boulevard is situated in northwest Calgary in the communities of Parkdale and Point McKay. It's classified as a future Urban Boulevard.

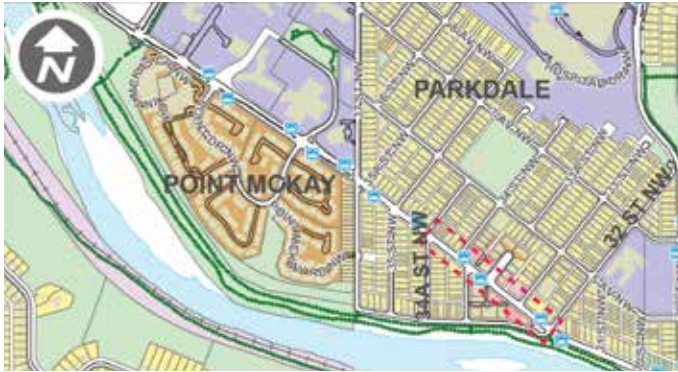

As summarized in the table below, this street has high residential density, local businesses, community services and an unpleasant pedestrian environment.

Site Characteristics	
Context	Local restaurants, multi-storey residential, community services, single detached dwellings, retailers, regional pathways, closer to the river, neighbourhood activity centre.
Activity	Walking, eating, recreation, meeting daily needs, sitting, community gathering.
Function	Transit route, car movement.
Land Use	Commercial, community services, residential (high, medium), open spaces.
Intersections	Auto-oriented, signalized pedestrian crossing.



**Before**

This roadway provides two driving lanes in each direction, no on-street parking, no bicycle facilities, and sidewalks on both sides but a very unattractive pedestrian experience.



**After**

Complete Street Improvements:

- 1 Decorative sidewalk treatment.
- 2 Public street trees.
- 3 On-street parking.
- 4 Street furniture.
- 5 Curb extension for pedestrian crossing.
- 6 Decorative street lighting elements.
- 7 Redeveloped at-grade retail & patio.



## Future Case Study – F7

**Neighbourhood Boulevard:** Bowness Road N.W. (between 45th and 46th Streets)

### Site Location/Characteristics

As shown in the site plan below, Bowness Road is situated in northwest Calgary in the community of Montgomery. It's classified as a future Neighbourhood Boulevard.

As summarized in the table below, this street has residential and commercial activity and an unpleasant pedestrian environment.



Site Characteristics	
Context	Shopping plazas, local restaurants, drinking establishments, medium-height residential buildings.
Activity	Shopping, eating, walking, biking.
Function	It's a transit route and it's part of the neighbourhood activity centre.
Land Use	Commercial, community services, residential (medium-density).
Intersections	Auto-oriented, crosswalk closure.



### Before

As illustrated, the pedestrian space is poor (narrow non-separate sidewalk with gravel spilling onto it), poor street lighting, no landscaping features.



### After

Complete Street Improvements:

- 1 Wider, separate sidewalk.
- 2 Landscaped boulevard with street trees.
- 3 Pedestrian scale lighting.

**Future Case Study – F8**

**Lane (residential):** 11th Street N.W. (near Gladstone Road)

**Site Location/Characteristics**

As shown in the site plan below, this typical residential lane is situated in northwest Calgary in the community of Hillhurst.



As summarized in the table below, the lane has very auto-oriented characteristics.

Site Characteristics	
Context	Single detached dwellings, medium-density residential.
Activity	Garbage collection, utility services, parking access.
Function	Services (garbage and utility).
Land Use	Residential.
Intersections	Auto-oriented.



**Before**

As illustrated, the pedestrian realm is poor. There is poor illumination, no defined edge to the public lane, and no green infrastructure.



**After**

Complete Street Improvements:

- 1 Decorative pavement treatment.
- 2 Fencing/green elements to define the lane.
- 3 Pedestrian-scale illumination.
- 4 Additional plants.



# Appendices

## APPENDIX B

---

### CTP Maps

The seven maps contained in this Appendix are duplicates of the maps found at the back of the Calgary Transportation Plan. These maps illustrate the 60-year vision of the Calgary transportation network. These must be referenced for every project the Transportation Department undertakes.

#### **Map 1: Primary Cycling Network**

Identifies high-priority bicycle routes where the most concentrated activity will occur. All other existing and future bicycle routes will be identified through periodic updates of the Calgary bikeway and pathway maps.

#### **Map 2: Primary Transit Network**

Identifies current and future frequent transit service, including skeletal light rail transit.

#### **Map 3: Downtown Transit Network**

A more detailed map identifying downtown transit corridors.

#### **Map 4: Conceptual Calgary Regional Transit Plan**

Identified current and future LRT, commuter rail, BRT, and potential high-speed rail infrastructure.

#### **Map 5: Primary Goods Movement Network**

Identifies main and supporting goods movement corridors, rail, intermodal yards, maintenance yards, and distribution facilities.

#### **Map 6: Primary HOV Network**

Identifies municipal and provincial auto and/or Transit focused high occupancy vehicle network.

#### **Map 7: Road and Street Network**

The revised Calgary Transportation Plan network using the revised street classifications.

#### **Figure B-1: Street Classification Map**

Developed by Transportation Planning and not contained within the CTP. This map expands on CTP Map 7 to include the Collector Streets.

Map 1: Primary Cycling Network

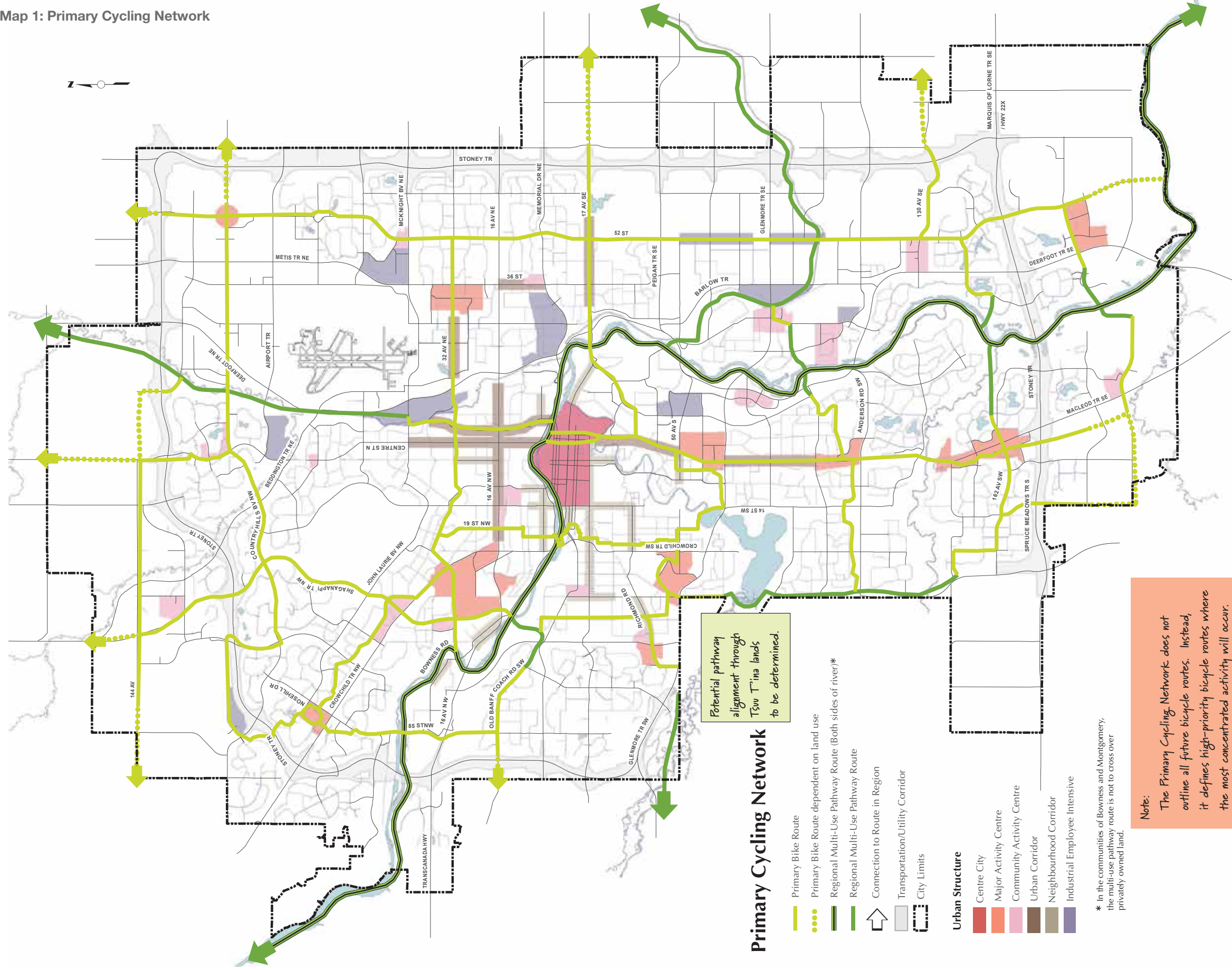

Potential pathway alignment through Tsu'u T'ina lands to be determined.

### Primary Cycling Network

- Primary Bike Route
- ⋯ Primary Bike Route dependent on land use
- Regional Multi-Use Pathway Route (Both sides of river)\*
- ⋯ Regional Multi-Use Pathway Route
- Connection to Route in Region
- Transportation/Utility Corridor
- City Limits

#### Urban Structure

- Centre City
- Major Activity Centre
- Community Activity Centre
- Urban Corridor
- Neighbourhood Corridor
- Industrial Employee Intensive

\* In the communities of Bowness and Montgomery, the multi-use pathway route is not to cross over privately owned land.

#### Note:

The Primary Cycling Network does not outline all future bicycle routes. Instead, it defines high-priority bicycle routes where the most concentrated activity will occur. All other existing and future bicycle routes will be identified through periodic updates of the Calgary bikeway and pathway maps.

This map represents a conceptual land use structure and transportation networks for the city as a whole. No representation is made herein that a particular site use or City investment, as represented on this map, will be made. Site specific assessments, including environmental contamination, private land ownership, as well as the future financial capacities of the City of Calgary must be considered before any land use or City investment decisions are made.



# Primary Cycling Network

X:\39\_Plan\_It\calgary\Business\_Tech\_Serv\GIS\Maps\_Plan\Document1\_Maps\CTP\_PrimaryCyclingNetwork.mxd

Map 2: Primary Transit Network

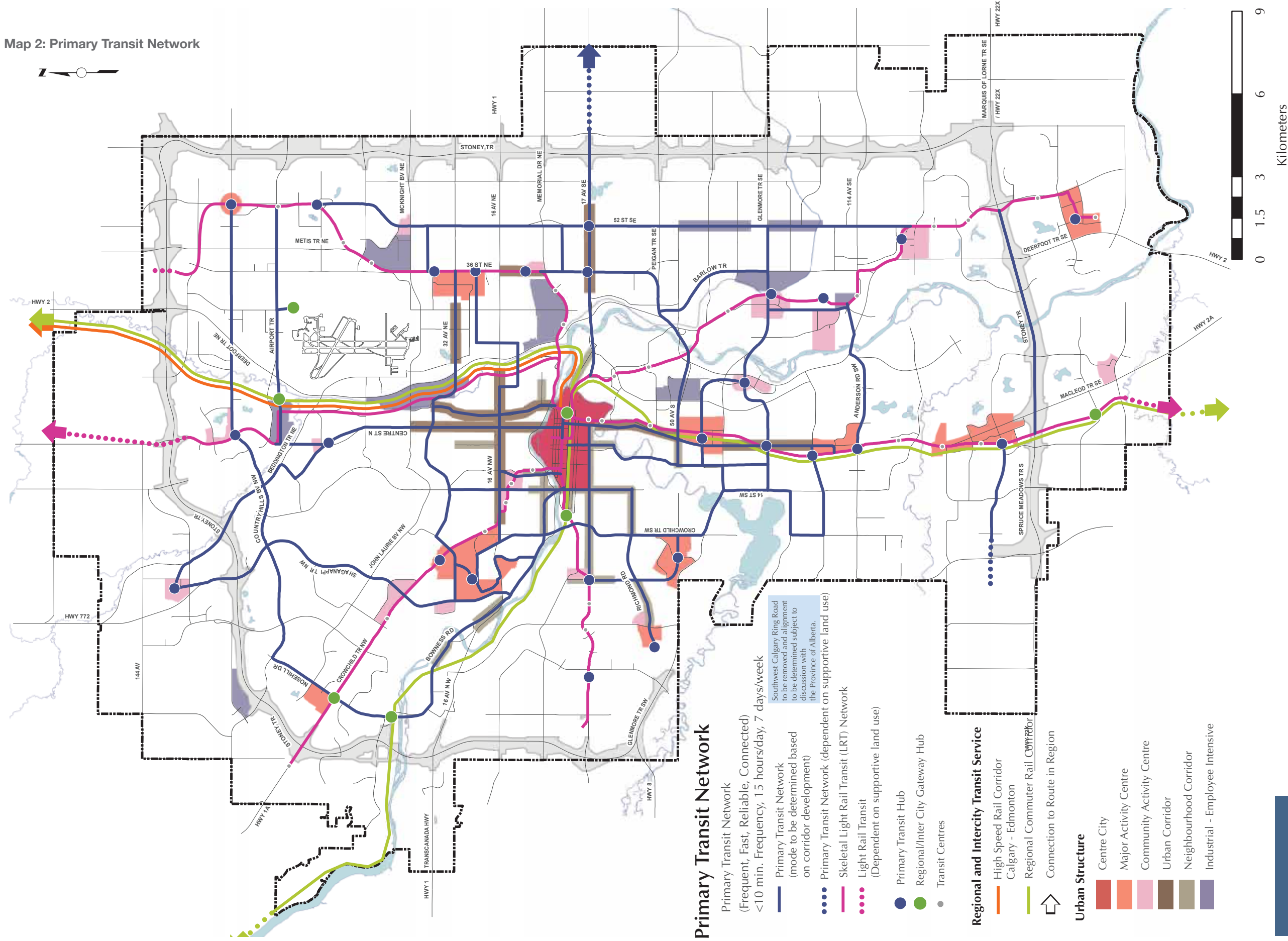

This map represents a conceptual land use structure and transportation networks for the city as a whole. No representation is made herein that a particular site use or City investment, as represented on this map, will be made. Site specific assessments, including environmental contamination, as well as the future financial capacities of the City of Calgary must be considered before any land use or City investment decisions are made.

# 2 Primary Transit Network

X:\39\_Plan\_It\_calgary\Business\_Tech\_Serv\GIS\Maps\_Plan\_Document\_Maps\PrimaryTransitNetwork.mxd



Map 3: Downtown Transit Network

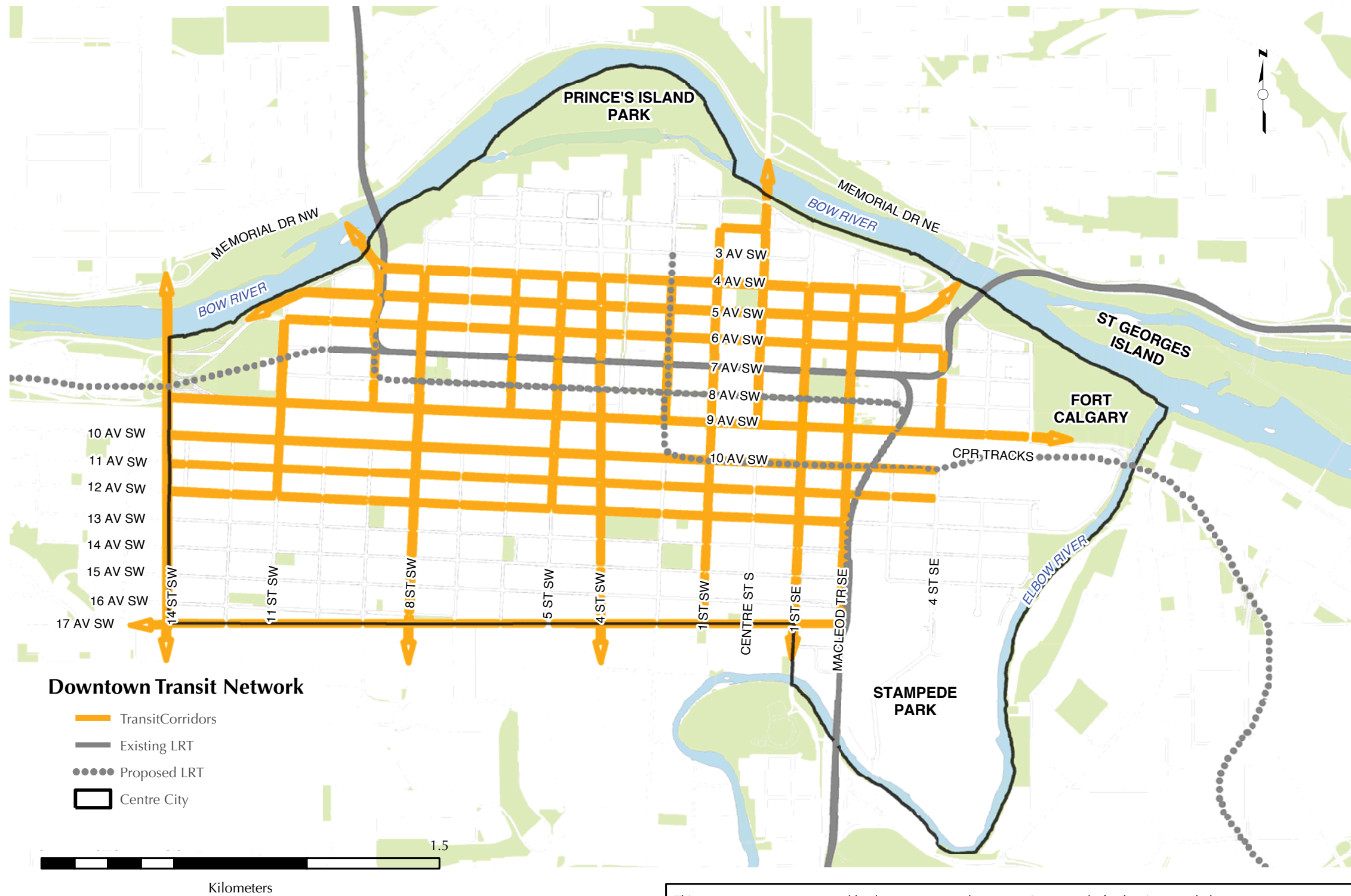

This map represents a conceptual land use structure and transportation networks for the city as a whole. No representation is made herein that a particular site use or City investment, as represented on this map, will be made. Site specific assessments, including environmental contamination, as well as the future financial capacities of the City of Calgary must be considered before any land use or City investment decisions are made.

# 3

# Downtown Transit Network

X:\39\_Plan\_it\_calgary\Business\_Tech\_Serv\gis\Maps\_Plan\Document\_Maps\DowntownTransitNetwork.mxd

Map 4: Conceptual Calgary Regional Transit Plan

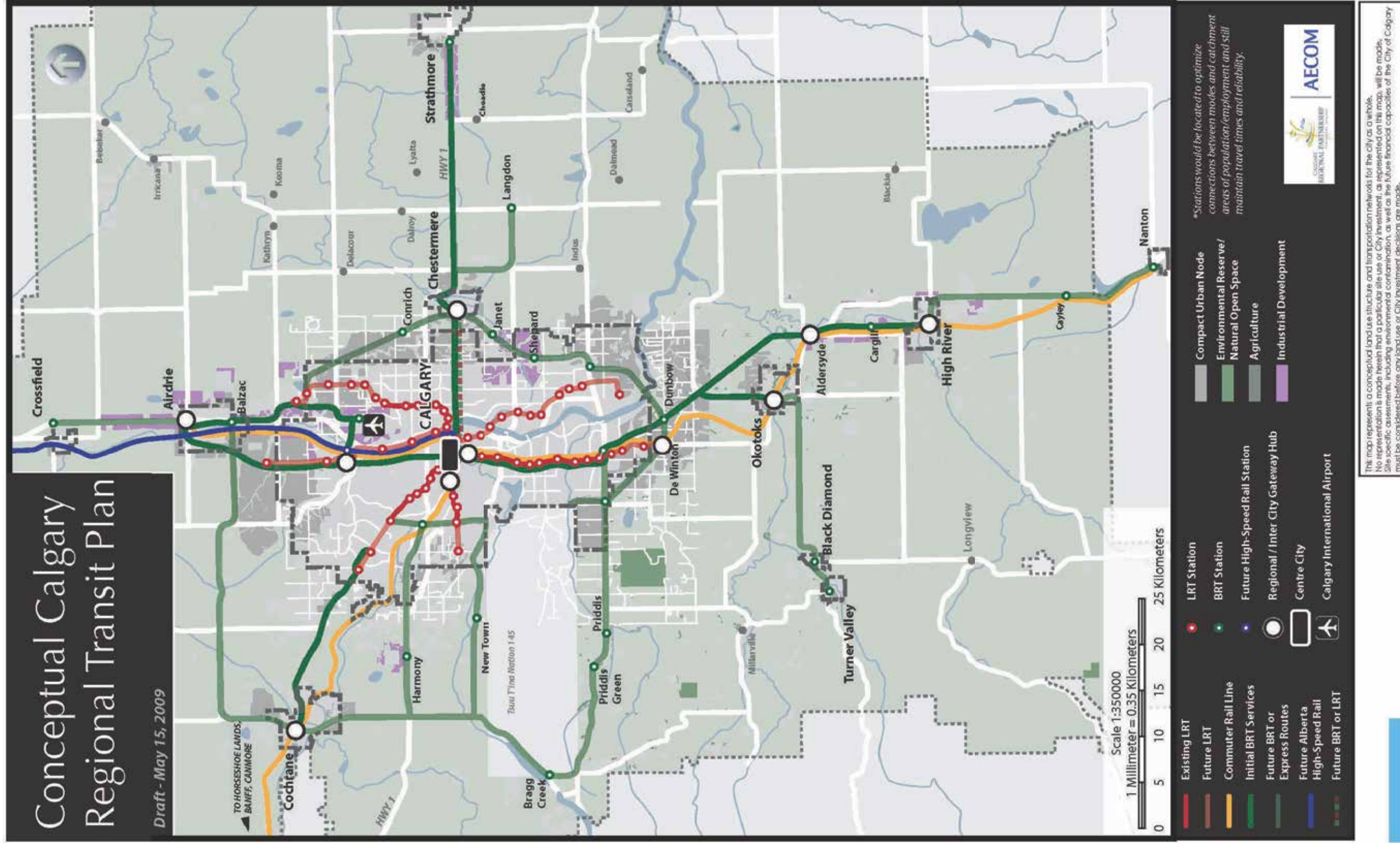

# 4 Conceptual Calgary Regional Transit Plan

X:\SR\_Plan\_U\_Calgary\Business\_Tech\_Serv\gh\Maps\_Plan\Document\_Maps\PDF\CIP\_ConceptualCalgaryRegionalTransitPlan



Map 5: Primary Goods Movement Network

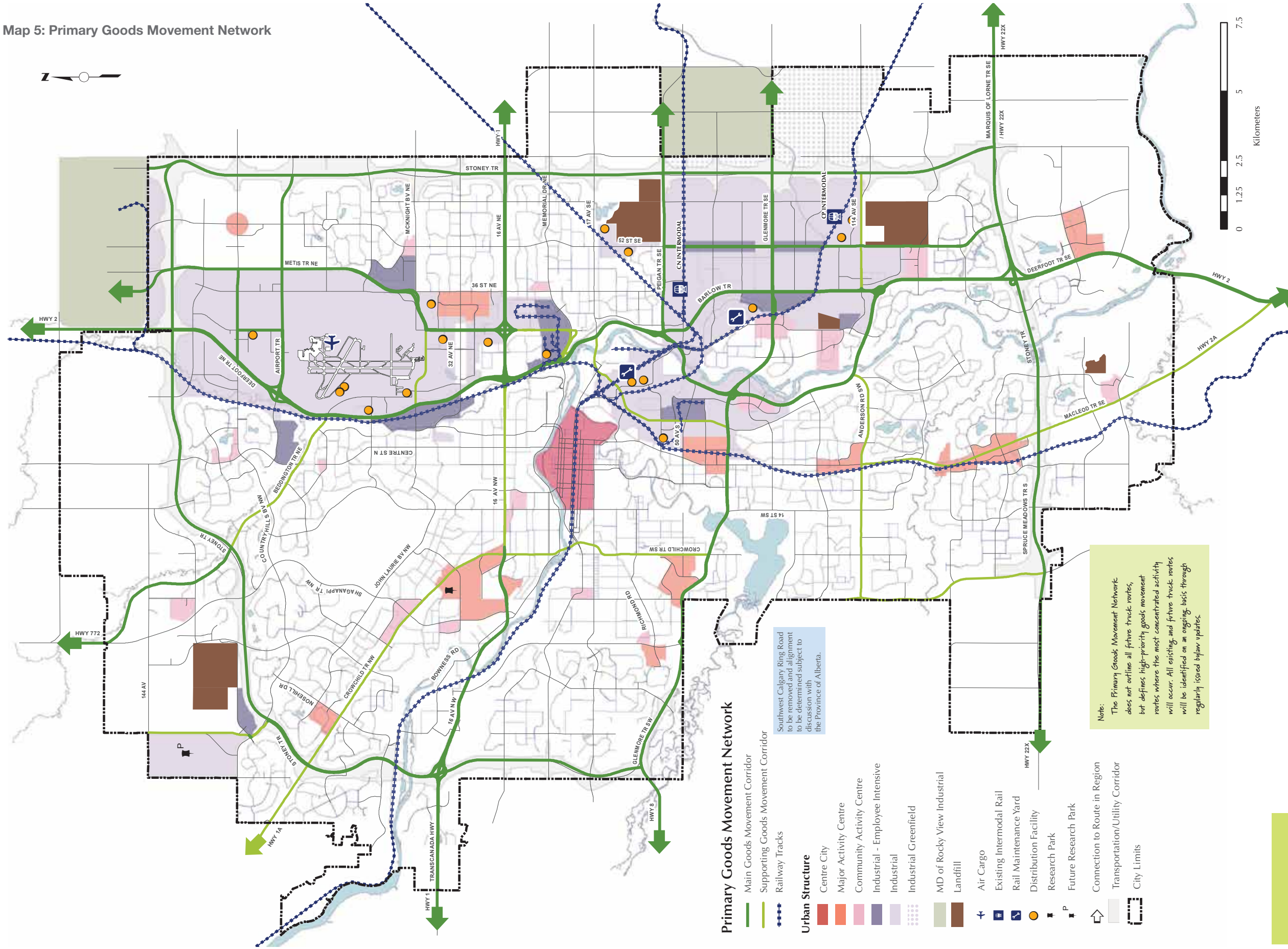

**Primary Goods Movement Network**

- Main Goods Movement Corridor
- Supporting Goods Movement Corridor
- - - Railway Tracks

**Urban Structure**

- Centre City
- Major Activity Centre
- Community Activity Centre
- Industrial - Employee Intensive
- Industrial
- Industrial Greenfield
- MD of Rocky View Industrial
- Landfill
- + Air Cargo
- Existing Intermodal Rail
- Rail Maintenance Yard
- Distribution Facility
- Research Park
- Future Research Park
- P P
- Connection to Route in Region
- Transportation/Utility Corridor
- City Limits

Southwest Calgary Ring Road to be removed and alignment to be determined subject to discussion with the Province of Alberta.

**Note:**  
The Primary Goods Movement Network does not outline all future truck routes, but defines high-priority goods movement routes where the most concentrated activity will occur. All existing and future truck routes will be identified on an ongoing basis through regularly issued bylaw updates.

# 5

# Primary Goods Movement Network

This map represents a conceptual land use structure and transportation networks for the city as a whole. No representation is made herein that a particular site use or City investment, as represented on this map, will be made. Site specific assessments, including environmental contamination, as well as the future financial capacities of the City of Calgary must be considered before any land use or City investment decisions are made.

X:\39\_Plan\_It\_Calgary\Business\_Tech\_Serv\GIS\Maps\_Plan\Document\_Maps\CTP\_PrimaryGoodsMovementNetwork.mxd



Map 6: Primary HOV Network

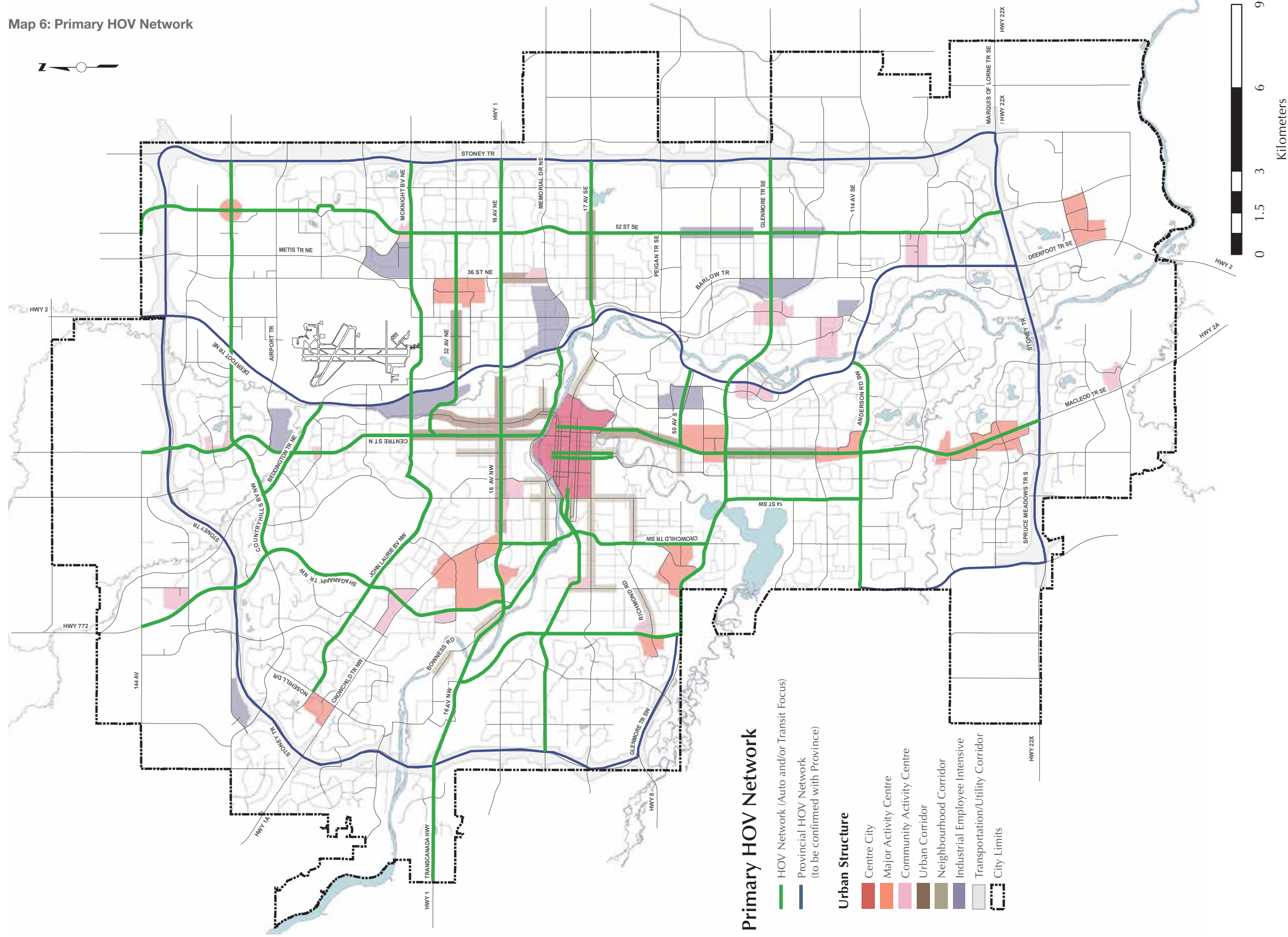

This map represents a conceptual land use structure and transportation networks for the city as a whole. No representation is made herein that a particular site use or City investment, as represented on this map, will be made. Site specific assessments, including environmental contamination, as well as the future financial capacities of the City of Calgary must be considered before any land use or City investment decisions are made.



# Primary HOV Network

X:\39\_Plan\_It\_Calgary\Business\_Tech\_Serv\GIS\Maps\_Plan\Document\_Maps\CIP\PrimaryHOVNetwork.mxd



Map 7: Road and Street Network

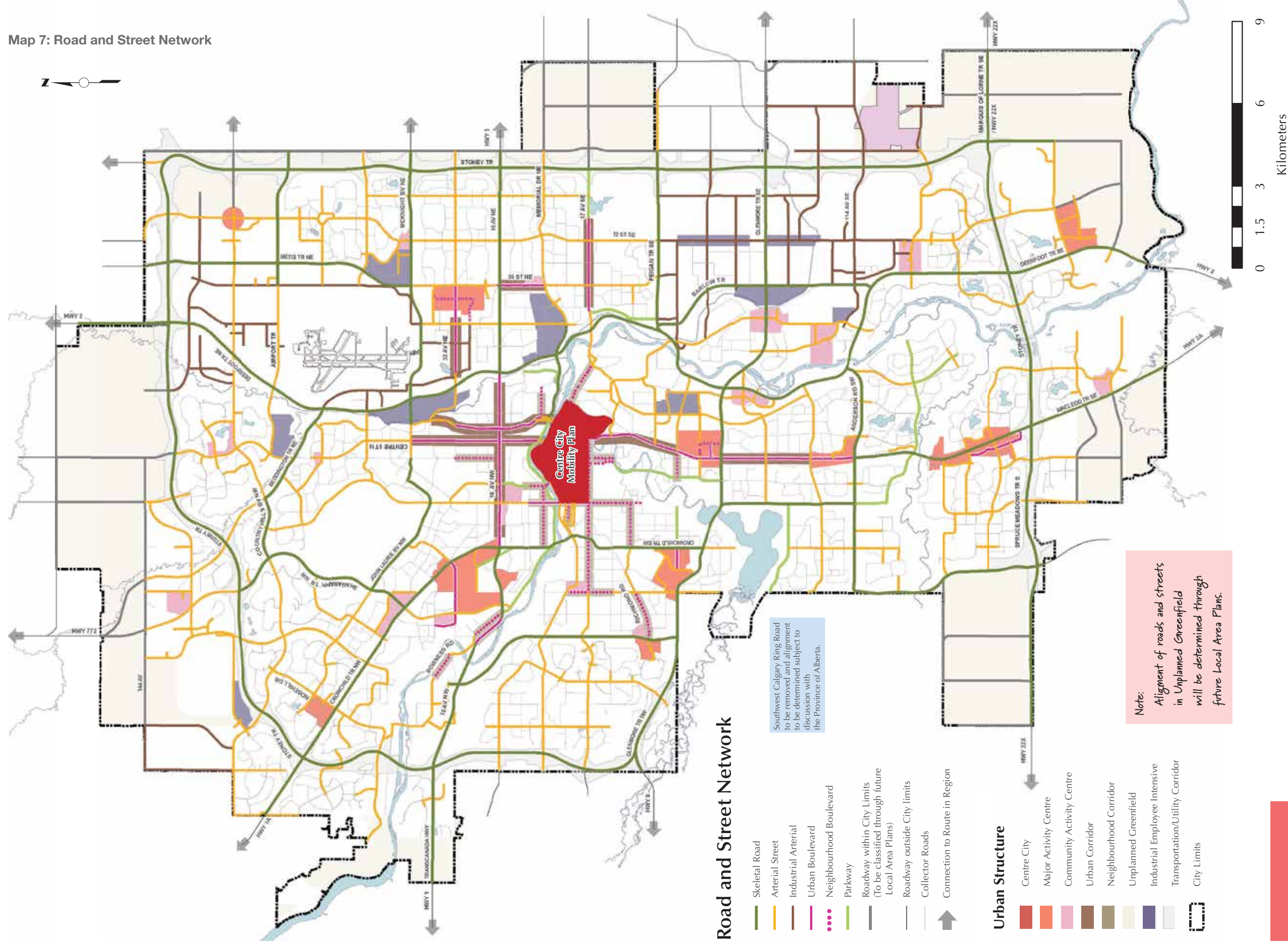

This map represents a conceptual land use structure and transportation networks for the city as a whole. No representation is made herein that a particular site use or City investment, as represented on this map, will be made. Site specific assessments, including environmental contamination, as well as the future financial capacities of the City of Calgary must be considered before any land use or City investment decisions are made.

# Road and Street Network

X:\39\_Plan\_it\_calgary\Business\_Tech\_serv\gis\Maps\_Plan\_Document\_Maps\MDP\RoadsAndStreetsNetwork2009.mxd



Map B1: Street Classification Map

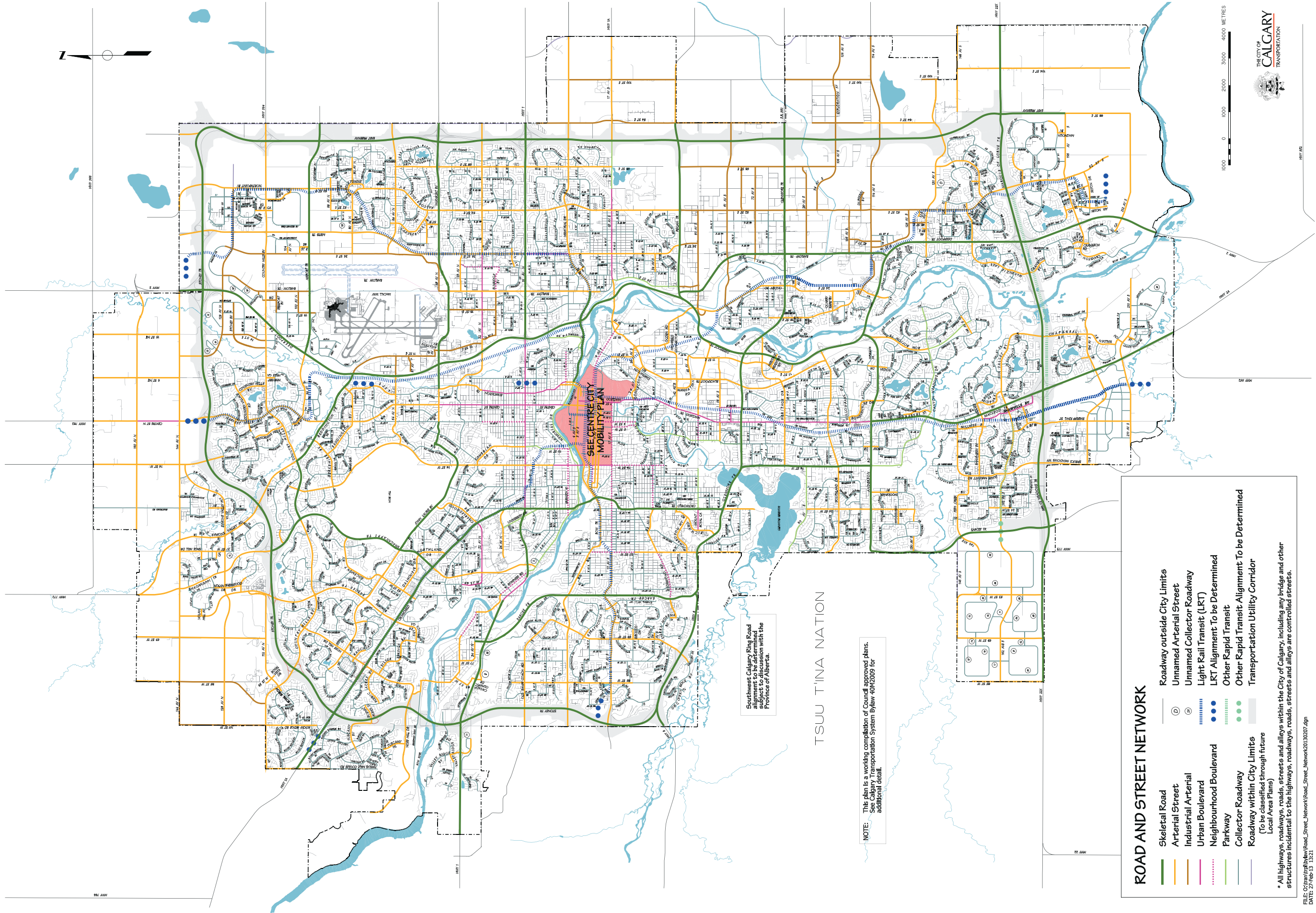

**ROAD AND STREET NETWORK**

- Skeletal Road
- Arterial Street
- Industrial Arterial
- Urban Boulevard
- Neighbourhood Boulevard
- Parkway
- Collector Roadway
- Roadway within City Limits (To be classified through future Local Area Plans)
- Roadway outside City Limits
- Unnamed Arterial Street
- Unnamed Collector Roadway
- Light Rail Transit (LRT)
- LRT Alignment To be Determined
- Other Rapid Transit
- Other Rapid Transit Alignment To be Determined
- Transportation Utility Corridor

\* All highways, roadways, roads, streets and alleys within the City of Calgary, including any bridge and other structures incidental to the highways, roadways, roads, streets and alleys are controlled streets.

FILE: C:\transport\highway\Road\_Network\Road\_Network20130207.dgn  
DATE: 2/7/13 10:13:21





# Appendices

## APPENDIX C

---

### **Complete Streets Scoring Tool**

The scoring tool has only been developed for the new Liveable Streets as there are targets (# of kilometres) set for only those streets. Values in black text are set weighting factors as determined by the modal priorities in the Road and Street Palette of the CTP. Red values are variable and just for illustrative purposes. A 70-point score is considered the “minimum” threshold for a section of street to meet the “Complete” criteria. This scoring tool is only in its draft stage.

Table C-1: Complete Streets metric calculations for scoring

COMPLETE STREETS SCORING TOOL						
PARKWAY	Walking	Cycling	Transit	Goods	Autos	TOTAL
Level of Accommodation (Figure 3 CTP)	High	High	Variable	Not required	Variable	
Mode Score (out of 100)**	70	70	70	–	70	
Weighting (out of 1.00)	0.35	0.35	0.15	0.00	0.15	
Weighted score	25	25	11	–	11	70

**\*\*Level of accommodation met if:**

Walking – 2.0 m separated walk or 3.0 m pathway on both sides

Cycling – 3.0 m pathway or bike lanes both sides

Transit – separate waiting area, 3.5 m curb lane

Goods/Autos – 3.5 curb lane, moderate delay (60 sec/intersection)

COMPLETE STREETS SCORING TOOL						
URBAN BOULEVARD	Walking	Cycling	Transit	Goods	Autos	TOTAL
Level of Accommodation (Figure 3 CTP)	High	High	High	Variable	Variable	
Mode Score (out of 100)**	70	70	70	70	70	
Weighting (out of 1.00)	0.25	0.25	0.25	0.13	0.12	
Weighted score	18	18	18	9	8	70

**\*\*Level of accommodation met if:**

Walking – 3.0 m separated walk or 3.5 m pathway on both sides

Cycling – 3.5 m pathway or bike lanes both sides

Transit – separate shelter/waiting area, 3.5 m curb lane

Goods/Autos – 3.5 curb lane, moderate delay (60 sec/intersection)

COMPLETE STREETS SCORING TOOL						
NEIGHBOURHOOD BOULEVARD	Walking	Cycling	Transit	Goods	Autos	TOTAL
Level of Accommodation (Figure 3 CTP)	High	High	High	Not required	Not required	
Mode Score (out of 100)**	70	70	70	–	–	
Weighting (out of 1.00)	0.35	0.35	0.30	0.00	0.00	
Weighted score	25	25	21	–	–	70

**\*\*Level of accommodation met if:**

Walking – 3.0 m separated walk or 3.5 m pathway on both sides

Cycling – 3.5 m pathway or bike lanes both sides

Transit – separate shelter/waiting area, 3.5 m curb lane

Goods/Autos – high delay (120 sec/intersection)

# Appendices

## APPENDIX D

### Related City Guidelines and Policies

This Appendix contains Transportation-related City of Calgary guidelines, policies, and plans beyond the scope of this Guide that currently exist or are under development.

#### D.1 CYCLING STRATEGY

Approved by Council in 2011, the Cycling Strategy identifies 50 actions and a number of targets for the short, medium and long term that will help make cycling a more comfortable and convenient travel option for more Calgarians. The underlying vision for the Cycling Strategy is to make Calgary a bicycle-friendly city for all to enjoy – whether you commute to work, run errands or cycle just for the joy of it. This vision will be achieved by focusing on three key areas:

1. Plan, design and build a network of bikeways that are attractive to the public.
2. Operate and maintain our new and existing bikeway facilities year-round.
3. Educate and promote bicycling and issues related to bicycling to help raise awareness and expand the bike culture in Calgary.

Visit the Cycling Strategy web page for more:

<http://www.calgary.ca/Transportation/TP/Pages/Cycling/Cycling-Strategy/Cycling-Strategy.aspx>

Figure D.1-1: Cycling Strategy



## D.2 CENTRE CITY MOBILITY PLAN

The Centre City Mobility Plan provides immediate guidance for development applications and transportation corridor development in the Centre City. It is an initiative to implement concepts from the Centre City Plan (CCP) and review the role and function of the rights-of-way within the Centre City.

The Centre City Mobility Plan updates the street classifications for the Centre City within the area boundaries, and identifies streetscape character, the pedestrian network, bicycle network, and transit network for all streets in the Centre City.

Visit the Centre City Mobility Plan web page for more: <http://www.calgary.ca/Transportation/TP/Pages/Planning/Centre-City/Centre-City-Mobility-Plan.aspx>

Figure D.2-1: Centre City Mobility Plan

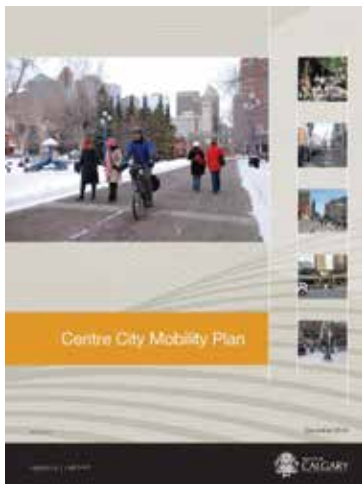

Figure D.2-2: Centre city bicycle network



## D.3 ROUNDABOUT POLICY AND GUIDELINES

A traffic roundabout is a type of intersection control device with a central island that allows freer movement of vehicles than traditional signalized and signed intersections.

Figure D.3-1: Roundabout – undivided primary collector

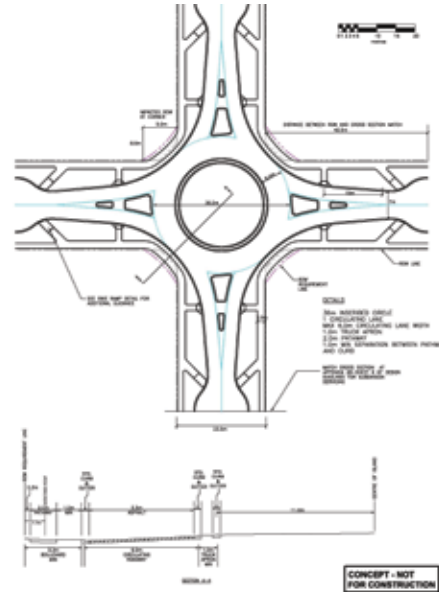

Traffic enters the roundabout and circulates counter-clockwise, to the right of the central island. Vehicles entering the roundabout must yield to all traffic already in the roundabout.

There are many benefits to traffic roundabouts:

- increased traveller safety;
- reduced travel delay;
- economical;
- reduced unnecessary idling and air pollution; and
- may improve the appearance of streets and intersections.

Roundabouts have fewer conflict points, slower speeds, and are easier to negotiate than other traffic management methods. There are fewer collisions and fewer injuries from collisions when roundabouts are used. Free-flowing traffic allows for reduced travel times and reduced environmental impacts. The operations and maintenance expense of roundabouts is less than that of traffic signals.

Roundabouts are safe and efficient, but they are not the ideal solution for every intersection. As with the decision to install traffic signals and other control devices, numerous factors are evaluated when deciding the best control for an intersection. Life-cycle cost, land requirements, safety, operations and other factors need to be considered.



Council approved a roundabout policy in April 2011. It stipulates that roundabouts are the preferred traffic control measure on Arterial and Collector Roadways in Greenfield areas where a new intersection is planned that warrants or may warrant a future traffic signal or all-way stop. In existing developed areas, roundabout use should be considered where a traffic control upgrade is warranted, capital improvements are being considered or safety or capacity issues have been identified.

The policy is to be applied for development application review, capital projects, and replacement activities. To view or download the guidelines, visit:

<http://www.calgary.ca/CA/city-clerks/Documents/Council-policy-library/tp016.pdf>

Roundabout guidelines have been developed as a resource for design, right-of-way requirements, and landscaping. To view or download the guidelines, visit:

<http://www.calgary.ca/Transportation/TP/Documents/Safety/Roundabout-Guidelines.pdf>

### **Landscaping Within Roundabouts**

Roundabouts provide the opportunity to accommodate landscaping within the inner circle and the splitter islands. The landscaping within and adjacent to a roundabout has a direct impact on the safety and operation of the intersection.

If any landscaping features (other than grass) are proposed for the centre island, then a detailed landscaping plan is required. This can be a separate circulation from the construction set, and would usually go through Parks and Roads for comments. It is preferred to have any landscaping features maintained by a resident/community association through an optional amenities agreement.

The appropriate Stopping Sight Distance, based on the entry speed to the roundabout (typically 35 km/h for an Urban Single Roundabout – from FHWA Exhibit 1-7) is required. This will affect any proposed landscaping layouts. Typically, the deep utilities will end up aligning through (under) the centre island in the roundabout. This will place limitations on the type of landscaping features that can be used in the centre island (such as trees) due to the proximity of the deep utilities.

The Transportation Department is in the process of developing landscaping guidelines for roundabouts in the city. The following are some guidelines for landscaping based on preliminary discussions within Roads:

1. Good landscaping design provides adequate stopping sight distance and encourages appropriate speeds on the approaches. This is accomplished by providing only the required sight distance and not more. Sightlines are required both at the centre of the roundabout and the outside edges where pedestrians and crosswalks are present.
2. The inner circle of the roundabout is broken up into two areas for landscaping purposes, the High Landscaping Zone and the Low Landscaping Zone.
3. The High Zone is located in the centre of the roundabout. This zone is the most important for establishing a visual mass to the roundabout. Since the finished ground is usually highest at the centre of the roundabout, it serves as a visual cue that drivers should reduce their speed on the approaches. Trees and boulders are acceptable elements for the High Zone. Evergreens are preferable to deciduous trees as evergreens provide visual screening throughout the year, although combinations of the two tree types may be considered. For any deciduous trees, the canopy height should have a clearance of 1.80 m from the ground to the lower branches to allow for unobstructed sightlines. It is acceptable to place fixed objects (such as entrance/community signs) within the High Zone as long as they are outside the direct path of the approaches and do not pose an unreasonable risk if drivers have an accident into the centre island.
4. At most roundabouts the risk of an accident occurring within the high zone is extremely low since approaching vehicles would have to be travelling at a high rate of speed, fail to make any steering corrections and cross over one or two barrier curbs prior to entering the High Zone. The size (diameter) of the High Landscaping Zone is typically determined by sightline calculations.
5. The Low Zone includes areas of the intersection where sight distance must be maintained throughout the year. These areas tend to coincide with clear zones (as determined by guidelines from the Transportation Association of Canada or TAC) where fixed objects are not permitted. Grasses and hearty low plantings (shrubs, bushes) are appropriate as are certain types of hardscapes. Care should be taken that as the plants mature, they do not require excessive maintenance (pruning) to maintain the

appropriate sight distances. The vertical height of the mature plantings should not exceed 0.60 m above the roadway. Plants with strong drought tolerance are strongly encouraged to help reduce water usage. With the centre circle, it is important to remember that the grading of the centre island will increase the elevation thereby further limiting the height of the plantings. Please be aware that large plantings of low bushes and shrubs have the tendency to collect various debris such as paper & plastic bags, which can become unsightly if left in place.

6. The centre of a roundabout can be a visually attractive location. However, the design must balance the desire for an aesthetically attractive design and proper operation of the roundabout. The landscaping should not include features that invite pedestrians to the centre island. Benches, large grassed areas (potential picnic area), statues with nameplates and climbing objects should be avoided in the centre island. Fountains or irrigation systems should be avoided in most applications as water tends to spray on the circulating roadway (and vehicles driving on it). Fountains also tend to have higher maintenance requirements, thereby requiring a location in the centre island to park a maintenance vehicle. Public art can best be accommodated when the object(s) is best viewed from afar. Information signs, viewing areas, benches and other associated facilities should be located outside the operational area of the intersection near pathways and sidewalks.
7. Proposed designs for the roundabout landscaping should be circulated to both Roads and Parks for review and approval. If, sometime in the future, the landscaping is not maintained in an acceptable manner by the community association, or if there is a history of safety issues, Roads reserves the right to either have the landscape features modified or removed and replaced with grass. It will then be mowed to the standard for boulevard maintenance that is in place at that date. The location and placement of traffic control devices such as signage will take precedence over any proposed landscaping features. Existing traffic control signage is not to be disturbed without the prior approval of the Roads Traffic Engineering section.

#### D.4 TRANSPORTATION IMPACT ASSESSMENT (TIA) GUIDELINES

A Transportation Impact Assessment (TIA) is typically required to support the transportation aspects of a proposed development that has the potential of generating significant amounts of new transit users, pedestrians, bicycle and vehicular traffic, or has the potential of changing the mobility patterns in the area where the development is proposed.

In Calgary, as a rule of thumb, if a development has the potential of generating more than 100 person trips per hour (considering all modes) at any given peak period for any given mode, a TIA will be required. On occasions, despite the development not reaching this threshold value, a TIA will still be requested due to particular circumstances in the area surrounding the project or as a result of concerns of the surrounding/adjacent communities, or other circumstances that TDS deems appropriate to review.

The purpose of the TIA Guideline is to provide applicants, development and transportation consultants with the framework to prepare studies for The City of Calgary. It provides guidance around the process of preparing, basic information to include, and submitting TIAs.

To view or download the guide, visit:

[http://www.calgary.ca/Transportation/TP/Documents/Planning/Final-Transportation-Impact-Assessment-\(TIA\)-Guidelines.pdf](http://www.calgary.ca/Transportation/TP/Documents/Planning/Final-Transportation-Impact-Assessment-(TIA)-Guidelines.pdf)

Figure D.4-1: TIA Guidelines

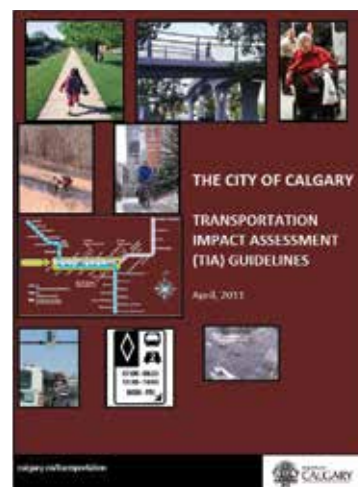

## D.5 INVESTING IN MOBILITY:

2013-2022 Transportation Infrastructure Investment Plan

Figure D.5-1: Investing in Mobility Guide

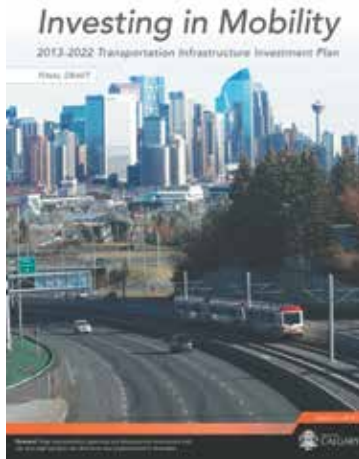

## D.6 RouteAhead: A STRATEGIC PLAN FOR TRANSIT IN CALGARY

In 2011, City Council directed that a new long-term plan for Calgary Transit be created in accordance with the principles and objectives of the CTP. Early in 2012, a team was established to develop this plan – called RouteAhead. Extensive public engagement was conducted, and based on the feedback received and the visions and goals of the CTP, RouteAhead provides strategic direction for public transit in Calgary for the next 30 years. RouteAhead plan was approved by Council in March 2013.

The plan includes visions, directions and strategies to address the future customer experience, network/capital plan, and funding of public transit in Calgary. The plan has established a clear vision for Calgary Transit and will be used by City Council and Calgary Transit to make informed decisions regarding budget (capital and operating), fares, service hours and other major business decisions.

Figure D.6-1: RouteAhead: A Strategic Plan for Calgary Transit



Figure D.6-2: Inside of Route Ahead



## D.7 DOWNTOWN UNDERPASS URBAN DESIGN GUIDELINES

The Downtown Underpass Urban Design Guidelines (the "Guideline") is a non-statutory document (approved by Council in 2010) providing comprehensive urban design guidance for the development of new underpasses and any improvements to existing underpasses within the Centre City area. The Guideline includes urban design principles and design solutions that address common issues associated with Calgary's downtown underpasses related to the following categories: Safety, Connectivity, Accessibility, Context, Vitality, Greenery and Beauty.

The intent of the Guideline is to create best-practice solutions in underpass design and improvements that would guide the public and private sectors. It is intended to achieve high-quality public realm, pedestrian and cyclist linkages, as directed by the Centre City Plan. Underpasses are gateways to the Centre City's destinations for work, arts and culture, administration and retail. These gateways have to be designed as highly functional and inviting for the various needs of pedestrians, cyclists, public transit and motorists. The current physical state of the downtown underpasses is in obvious contradiction to their mobility and gateway functions within the Centre City.

This Guideline brings together a unified vision for all underpasses with careful considerations for local context. This context is described by selected criteria, which will allow a comprehensible and traceable evaluation for all Underpass Elements: bridge structure, retaining walls, active edges, lighting, sidewalk/multi-use pathways, medians, landscaping, universal design, pedestrian signage, utility infrastructure integration, and underpass art. The Guideline distinguishes between new underpasses and existing underpasses.

The successful 4th Street S.E. underpass is a pilot design using the principles of this Guideline. The intention of the pilot design was to demonstrate a range of design opportunities for all underpasses.

The successful implementation of this Guideline requires collaboration of affected business units within The City of Calgary.

To view or download the Guidelines, visit:  
<http://www.calgary.ca/PDA/LUPP/Documents/Publications/underpass-guidelines.pdf>

Figure D.7-1: Downtown Underpass Urban Design Guidelines



## D.8 URBAN DESIGN FRAMEWORK

Calgary is one of the most dynamic urban centres in Canada, providing the profile to attract business, residents and visitors from around the globe. In order to compete on an international level, cities everywhere are recognizing the importance of the combination of physical characteristics and public amenities that contribute to their image as attractive urban places in which to work and to live. In its short history, Calgary has and will continue to experience waves of extensive change to its form and urban fabric. Urban Design, as a discipline, provides a framework to direct this change toward the creation of a cohesive, functional, liveable and beautiful city.

### Urban Design:

- contributes to the creation of places for people that are attractive, memorable and functional;
- concerns the arrangement, shaping, appearance and functionality of urban public space;
- addresses the quality of the interface between buildings and the public realm, wherever buildings are involved in framing and shaping space, to ensure animation and vitality; and
- is achieved through the co-ordination of all related disciplines, including planning, transportation planning, architecture, engineering, and landscape design to achieve striking and effective results.

Received by the Calgary Planning Commission in July 2011, this document:

- provides a framework for actions intended to achieve the formalization of an ad hoc internal business practice that recognizes the importance of urban design as a fundamental part of various initiatives across multiple business units;
- serves as a guide for effective collaboration between business units and outlines the protocol for ensuring that urban design is addressed at the early stages of project, policy, and application work, when design input can be most effective and most efficiently incorporated or responded to; and
- provides information and clarification with regard to the role of the Urban Design team within Land Use Planning & Policy and the design expertise that it can provide to a variety of projects and initiatives across the Corporation.

To view or download this document visit:  
<http://www.calgary.ca/PDA/LUPP/Documents/Publications/urban-design-framework.pdf>

Figure D.8-1: Urban Design Framework





## D.9 TRANSIT ORIENTED DEVELOPMENT (TOD) PLANNING FRAMEWORK (UNDER DEVELOPMENT)

Transit oriented development (TOD) is a walkable, mixed-use form of area development typically focused within a 600 m radius of a transit station – a Light Rail Transit (LRT) station or Bus Rapid Transit (BRT) stop, prior to the arrival of LRT. Higher-density development is concentrated near the station to make transit convenient for more people and encourage ridership. This form of development utilizes existing infrastructure, optimizes use of the transit network and creates mobility options for transit riders and the local community. Successful TOD provides a mix of land uses and densities that create a convenient, interesting and vibrant community for local residents and visitors alike.

As part of The City of Calgary’s ongoing commitment to create great places to live within our city, a Transit Oriented Development Framework is being created to:

- assist communities, City staff, and City Council in making decisions regarding development proposals around existing and future important transit stations, like CTrain and Bus Rapid Transit (BRT) stops;
- highlight opportunities for TOD across the city, and
- help City staff invest strategically at TOD areas

The TOD Framework will provide guidelines for urban design and land use principles to create an attractive, urban, walkable environment where there are opportunities to live, work, shop, and play without depending primarily on the automobile. The TOD Framework is intended to replace the Transit Oriented Development Policy Guidelines approved by City Council in December 2004. The TOD Framework will be used to provide land use and development guidance at both LRT and BRT stations, where a Station Area Plan is not in place.

For more information, visit the Transit Oriented Development (TOD) web page:  
[http://www.calgary.ca/PDA/LUPP/Pages/Current-studies-and-ongoing-activities/Transit-oriented-development-tod/Transit-Oriented-Development-\(TOD\).aspx](http://www.calgary.ca/PDA/LUPP/Pages/Current-studies-and-ongoing-activities/Transit-oriented-development-tod/Transit-Oriented-Development-(TOD).aspx)

Figure D.9-1: Transit Oriented Development Planning Framework



## D.10 LARGE COMMERCIAL URBAN DESIGN GUIDELINES (UNDER DEVELOPMENT)

The City is developing urban design guidelines for large commercial sites. These are the shopping areas that usually consist of one or more large (commonly called “big-box”) stores surrounded by several smaller retail stores, cafes, restaurants, banks, gas stations and other facilities.

The proposed guidelines will be presented to City Council for their consideration in early 2014.

Urban design guidelines form the foundation for how City staff evaluate proposed private developments. They outline things such as how new buildings should be arranged on the property; how things such as on-site streets, sidewalks, amenity spaces and parking lots should be laid out; and how new developments should be connected to the surrounding community.

The proposed new guidelines would apply throughout the entire city, except for the Centre City, and will give direction for the development of new large commercial sites and redevelopment of existing ones.

**Guideline Purpose**

The vision of the proposed Large Commercial Urban Design Guidelines is to ensure that commercial development is progressing in a way that is financially, environmentally and socially sustainable. Private retail sites in new communities are also increasingly becoming the place that people gather to socialize and recreate, so the design of these sites can play an integral role in setting the tone of a community, and the way we live our public lives.

The proposed Large Commercial Urban Design Guidelines will provide consistent guidance to developers and City staff to help ensure that large commercial sites:

- create a pleasant public realm;
- allow for safe pedestrian and bicycle movement to and within the site;
- reduce the need for car travel to and within the site;
- can be adapted for other uses or intensified (e.g., having more density added or a greater variety of development) in the future; and
- are environmentally sustainable.

If approved by City Council, the proposed guidelines will shorten the time it takes to review development applications for commercial sites while ensuring that developments better align with the goals of the Municipal Development Plan.

For more information, visit the Large Commercial Urban Design Guidelines web page:  
<http://www.calgary.ca/PDA/LUPP/Pages/Current-studies-and-ongoing-activities/Citywide-large-commercial-urban-design-guidelines.aspx>

Figure D.10-1: Large Commercial Urban Design Guidelines



# Appendices

## APPENDIX E

---

### Glossary of Terms

#### Accessibility

Ease of access/egress to any location by walking, cycling, transit, and private vehicles, or for commercial vehicles. In terms of those with disabilities (including the elderly), the aim is to provide those pedestrian citizens with greater accessibility to the outdoors throughout the year.

#### Active Modes

Non-motorized travel, primarily walking and cycling but also includes roller-blading and movements with mobility devices.

#### Activity Centre

All areas defined as Major Activity Centres (MACs), Community Activity Centres (CACs) or Neighbourhood Activity Centres (NACs) in the MDP, and as shown on the MDP Urban Structure (Map 1).

#### Complete Community

A community that is fully developed and meets the needs of local residents through an entire lifetime. Complete Communities include a full range of housing, commerce, recreational, institutional and public spaces. They provide a physical and social environment where residents and visitors can live, learn, work and play.

#### Complete Street

A street that moves people, by foot, bike, bus and car; provides places where people can live, work, shop and play; supports the natural environment; facilitates movement of trucks and service vehicles, and supports our economy.

#### Connectivity Index

A score used to measure the amount of connectivity (of all modes) a network has. There are two indices: Street and Active Modes. The Street Connectivity Index is calculated as the ratio of street links to street nodes. The Active Modes Connectivity Index is calculated as the ratio of street, walkway, and pathway links to nodes.

#### Green Alley

An alley designed to reduce environmental impacts and discharges to the storm sewer system. The design will allow rain water to percolate through vegetation or porous pavement to the ground, providing natural drainage. Increased vegetation will filter storm water and may improve air quality.

**Green Building**

Green building practices aim to reduce the environmental impact of buildings (e.g., vegetated roof to reduce storm run-off).

**Green Infrastructure (GI)**

An interconnected network of natural green and engineered green elements applicable at multiple scales. Natural green elements include the conservation and integration of traditional green elements including trees, wetlands, riparian areas and parks. Engineered green elements include systems and technologies designed to mimic ecological functions, or to reduce impacts on ecological systems. GI examples include green alleys, green buildings and green roadways.

**Green Roadways**

Roadways that utilize storm water management strategies with features such as street trees, landscaped swales and special paving materials that allow infiltration and limit runoff.

**Impervious Surfaces**

Mainly artificial structures, such as building roofs, roadway pavements, sidewalks, and parking lots, that cannot be easily penetrated by water, thereby resulting in runoff.

**Low Impact Development (LID)**

An approach to land development that uses various land planning and design practices and technologies to simultaneously conserve and protect natural resource systems and reduce infrastructure costs (e.g., bioswales).

**Mode (or Modal) Split**

The proportion of total person trips using each of the various modes of transportation. The proportion using any one mode is its modal share. Together, transit, cycling, and walking trips make up the non-auto modal share.

**Monolithic Sidewalk**

A sidewalk structure where the curb, gutter, and sidewalk are one (i.e., no boulevard separates the curb from the sidewalk).

**Pedestrian-Oriented**

An environment designed to make travel on foot convenient, attractive and comfortable for various ages and abilities. Considerations include directness of the route, interest along the route, safety, amount of street activity, separation of pedestrians and traffic, street furniture, surface material, sidewalk width, prevailing wind direction, intersection treatment, curb cuts, ramps and landscaping.

**Public Realm**

The region of a street right-of-way between buildings and the driving lanes used by pedestrians. It can include sidewalks, street furniture, street trees, signs, street lights, and patio space.

**Right-of-Way (ROW)**

Publicly owned land containing roads and streets and/or utilities.

**Road Diet**

A technique to reduce the number of lanes on a roadway cross-section. One of the most common applications of a road diet is to improve space for other users (e.g., pedestrians, cyclists) in the context of two-way streets with two lanes in each direction.

**Street**

Roadways that are designed to accommodate all modes of transportation (to varying degrees depending on the specific street type). They also contribute to a sense of place, and typically provide more streetscape elements than roads.

**Streetscape**

All elements that make up the physical environment of a street and define its character. This includes paving, trees, lighting, building type, setback style, pedestrian, cycle and transit amenities, street furniture, etc.

**Transit Oriented Development (TOD)**

A walkable, cyclable, mixed-use form of development typically focused within 600 m of a transit station (LRT or BRT). Its intent is to create mobility options for a higher density of transit riders and the local community.

**Typology**

Defines the key geographic areas within the urban boundary that share common characteristics. Typologies establish the framework within which more detailed land use designations and policies can be established. Integral to each typology and the city as a whole are the "Road and Street Palette" and transit services, which are integrated with land use or typologies.

**Universal Design**

The design of products and environments to be useable by all people (of all abilities) to the greatest extent possible, without the need for adaptation or specialized design.

**Urban Forest**

All the trees and associated vegetative understory in the city, including trees and shrubs intentionally planted, naturally occurring, or accidentally seeded within the city limits.



# Appendices

## APPENDIX F

### Other Publications

#### Edmonton, AB: Complete Streets Guidelines

[http://www.edmonton.ca/city\\_government/documents/RoadsTraffic/Edmonton-Complete-Streets-Guidelines\\_05062013.pdf](http://www.edmonton.ca/city_government/documents/RoadsTraffic/Edmonton-Complete-Streets-Guidelines_05062013.pdf)

Figure F-1: Edmonton – Complete Streets Guidelines



Toronto Centre for Active Transportation (TCAT): Complete Streets by Design

[http://tcat.ca/sites/all/files/CSxD\\_WebSpreadsMay2012.pdf](http://tcat.ca/sites/all/files/CSxD_WebSpreadsMay2012.pdf)

Figure F-2: Toronto – Complete Streets by Design



Abu Dhabi, UAE: Urban Street Design Manual

<http://www.upc.gov.ae/template/upc/pdf/USDM-Manual-English-v1.1.pdf>

Figure F-3: Abu Dhabi – Urban Street Design Manual



Philadelphia Complete Streets Design Handbook

<http://philadelphiastreet.com/pdf/CSHandbook-2013.pdf>

Figure F-4: Philadelphia – Complete Streets Design Handbook



## Philadelphia NACTO Urban Street Design Guide Overview

[http://nacto.org/wp-content/uploads/2012/11/NACTOUrbanStreetDesignGuide\\_Highrez.pdf](http://nacto.org/wp-content/uploads/2012/11/NACTOUrbanStreetDesignGuide_Highrez.pdf)

Figure F-5: Philadelphia – NACTO Urban Street Design Guide



## New York Department of Transportation Street Design Manual

<http://www.nyc.gov/html/dot/html/about/streetdesignmanual.shtml>

Figure F-6: New York – Street Design Manual



Los Angeles County Model Design Manual for Living Streets

<http://www.modelstreetdesignmanual.com/download.html>

Figure F-7: Los Angeles County – Model Design Manual for Living Streets

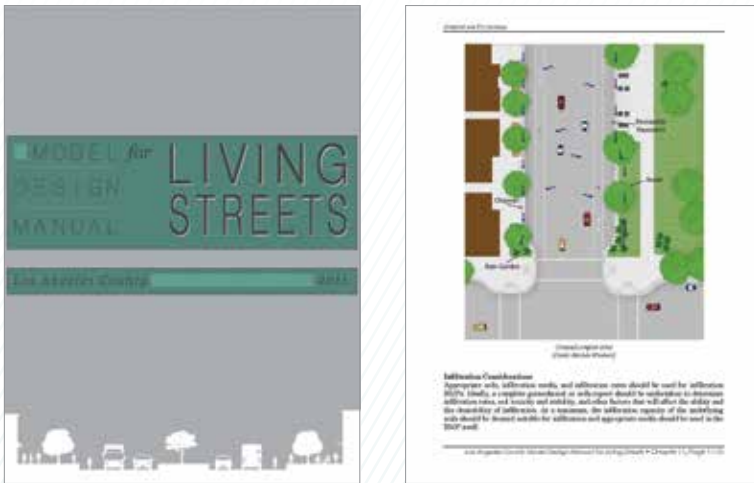



# Appendices

## APPENDIX G

---

### **Continuing Research**

The City of Calgary has established a partnership with the University of Calgary (the “Urban Alliance”) to conduct research on a number of priority (and Complete Streets related) transportation design topics. These research topics will be rolled into the Faculty of Environmental Design course curriculum for the 2012-2013 and 2014-15 semester years. Transportation Planning staff will work closely with Environmental Design professors to scope and guide the research projects. The priority projects are summarized in Table G-1.

Table G-1: Priority research topics

PRIORITY RESEARCH TOPICS
<b>SAFETY</b>
Adaptive technologies for pedestrian and cycle signalized crossings
Safety treatments for peds and bikes crossing interchange ramps
<b>PEDESTRIAN DESIGN</b>
LRT pedestrian crossing safety
Mid-block ped crossing treatments for new road types
Cost- and safety-effective pedestrian crossing treatments on new road types
<b>BICYCLE DESIGN</b>
Criteria for cycle track network in downtown
Guidelines for site selection of bike stations, on-street bike parking modules, composition of bike stations
Transitioning downtown roads from no cycling facilities to cycle tracks – new conflicts created, mitigation measures, effectiveness, collision types and rates over time as number of cyclists increase
<b>TRANSIT DESIGN</b>
Criteria to determine priority transit travel time improvement projects (bus-only lanes, queue jumps, BRT corridors)
Study of urban design elements at existing bus stops – what attracts customers, what works for adjacent businesses, review of transit shelter and bench designs

# Appendices

## APPENDIX H

---

### References

#### Chapter 1: New Street Classifications

FHWA (Federal Highway Administration, US DOT) (2013).  
FHWA Functional Classification Guidelines

[http://www.fhwa.dot.gov/planning/processes/statewide/related/functional\\_classification/fc02.cfm](http://www.fhwa.dot.gov/planning/processes/statewide/related/functional_classification/fc02.cfm)

#### Chapter 2: Network Design Guidelines & Chapter 3: Street Design Guidelines

Los Angeles County Department of Public Health & Ryan Snyder Associates (2011).

Model Design Manual for Living Streets.

<http://www.modelstreetdesignmanual.com/>

#### Section 3.3: Bikeway Design

NACTO (National Association of City Transportation Officials) (2012).  
Urban Bikeway Design Guide. <http://nacto.org/cities-for-cycling/design-guide/>

#### Section 3.7: Intersection Design

NACTO (National Association of City Transportation Officials) (2012).  
Urban Street Design Guide: Overview <http://nacto.org/usdg-2013/>

#### Chapter 4: Retrofit Design

FHWA (Federal Highway Administration, US DOT) (2012).  
Context Sensitive Solutions Primer.

[http://www.fhwa.dot.gov/context/css\\_primer/](http://www.fhwa.dot.gov/context/css_primer/)





# Appendices

## APPENDIX I

---

### Acknowledgments

The completion of this Guide would not be possible without the contributions of the following individuals.

*Thank you!*

#### STEERING COMMITTEE

Mac Logan	General Manager, Transportation
Don Mulligan	Director, Transportation Planning
Ryan Jestin	Director, Roads
Gordon Stewart	Director, Transportation Infrastructure
Fred Wong	Director, Calgary Transit (past)
Doug Morgan	Director, Calgary Transit (present)
Mary Axworthy	Director, Land Use Planning & Policy (past)
Matthias Tita	Director, Land Use Planning & Policy
Stan Schwartzberger	Director, Development & Building Approvals (past)
Stuart Dalgleish	Director, Development & Building Approvals (present)
Anne Charlton	Director, Parks
Wolf Keller	Director, Water Resources (past)
Rob Spackman	Director, Water Resources (present)

**TECHNICAL COMMITTEE**

Joe Olson	Project Lead, Transportation Planning
Bob Berry	Manager, Development, Roads (past)
Ed Wong	Manager, Development, Roads (past)
John Bolger	Manager, Development, Roads (present)
Rob Talarico	Subdivision Development Engineer, Roads
Ed Lem	Engineering Development Division, Urban Development
Rene Letourneau	Urban Water Management, Water Resources
Doug Macdonald	New Communities, Land Use Planning & Policy (past)
Scott Lockwood	New Communities, Land Use Planning & Policy (present)
Deborah Cooper	Established Communities, Land Use Planning & Policy
Afrah Rayes	Urban Design & Heritage, Land Use Planning & Policy
Anne Marie Martino	Utility Line Assignment, Land Information & Mapping
Ivy Campbell	Fire/EMS (past)
Jim Heynen	Fire/EMS (present)
Michele Wong	Planning & Development, Parks
Jill-Anne Spence	Urban Forestry, Parks
Melanie Matwie	Waste – Recycling Services

**CONSULTING TEAM**

Nick Finn	Project Manager, DA Watt
Dave McElhanney	Project Manager/Senior Consultant, MBE Ventures
Jonathan Chapman	Project Manager, DA Watt
Grant Macdonald	Vice President, Engineering – Shallow Utilities, DA Watt
Bruce Nelligan	Transportation Manager – Road Safety
Tomasz Kroman	Senior Consultant
Richard Drdul	Consultant, Bicycling/Pedestrians
Hassan Karim	Consultant, Low Impact Development
Darrel Grant	Planning Consultant
Kristen Myers	Transportation Engineer, DA Watt
Teresa Morneau	Senior Transportation Engineer, DA Watt
Robin Bird	Project Analyst, Graphics, DA Watt
Bobby Ascano	Junior Transportation Engineer, DA Watt
Aparna Krishan	EIT, DA Watt
Marleine Rozsa	Graphics Consultant

## COMMUNICATIONS

Lorie Boychuck	Communications Consultant (past)
Sandy Swanton	Communications Strategist (past)
Peggy Chan	Communications Strategist (present)

## DOCUMENT DEVELOPMENT

Nathanael Au	Graphics Designer 2011 Interim Guide
Lisa Jeczmienski	Digital Media Designer
Jamie Morris	Creative Services Advisor

## PUBLIC REALM DESIGN CONTENT

Afra Rayes	Urban Design & Heritage, Land Use Planning & Policy
Andrea Buttazzoni	Planning Analyst, Technical Services
Carmen Kirk	Graphic Designer, Technical Services
Jeff Brown	Graphic Designer, Technical Services
Ke Zhou	Graphic Designer, Technical Services
Don McGeachy	Planning Analyst, Technical Services
Marc Hummel	Co-ordinator, Technical Services

## ADMINISTRATIVE

Wanda Callaghan	Executive Assistant Director, Transportation Planning
Fran Creelman	Supervisor Business Services, Transportation Planning
Shaheeda Kassam	FSCM Administrator, Transportation Planning

## Other Internal Contributors / Support

### TRANSPORTATION PLANNING

Azim Jivraj	Manager, Transportation Solutions Division
Ryan Vanderputten	Manager, Development Services Division
Anne Cataford	Manager, Network Planning Division (past)
Cameron Matwie	Manager, Network Planning Division (present)
Eric MacNaughton	Business Strategist, Strategy (Costs)
Zorana McDaniel	Business Strategist, Strategy (Monitoring)
Chris Blaschuk	Manager, Strategy (Network Design)
Stephen Kay	Senior Transportation Engineer, Network Planning
Blanka Bracic	Transportation Engineer, Solutions (Pedestrian Design)
Tom Thivener	Transportation Planner, Solutions (Bicycle Design)
Bruce McDougall	Transportation Planner, Solutions (Traffic Calming)
Pat Churchman	Senior Transportation Planner, Development Services

**OTHER BUSINESS UNITS**

Greg Iwaskow	Supervisor, Traffic, Roads
Canace Bain	Design Co-ordinator, Traffic, Roads
Robert Whyte	Transit Planner, City Transit (Transit Design)
David Couroux	Senior Planner, LUPP
Justin Pockar	Energy and Environmental Co-ordinator, DBA
David Down	Co-ordinator, Urban Design & Heritage
Thom Mahler	Established Communities, Land Use Planning & Policy
Keath Parker	Manager, Planning & Development Services, Parks
Debra Hamilton	CPAG Business Manager
Marc Sabraw	Utilities Planning Specialist, Infrastructure-Information Services
Fabian Snyders	Utilities Planning Specialist, Infrastructure-Information Services
Ken Clogg-Wright	Water Resources Specialist

**EXTERNAL STAKEHOLDERS**

David Thatcher	Urban Development Institute (UDI)
Amie Blanchette	Canadian Home Builders Association (CHBA), Calgary Region
John Thiessen	Co-ordinator, Shallow Utilities Consortium (Enmax, Shaw, Telus, ATCO)
Karly Morgan	Federation Calgary Communities
Brent Clark	President, Bike Calgary
Leanne Squair	Advisory Committee on Accessibility (ACA)
Kathryn Winkler	Sustainable Alberta Association
Robert Homersham	Commercial Real Estate Development Association (NAIOP)