

SOUTH SHAGANAPPI STUDY

Introduction

1.0 INTRODUCTION

Shaganappi Trail NW serves as a vital link in The City of Calgary's transportation network, providing connections to the Montgomery, Point McKay, Parkdale, Edworthy Park, and University Heights areas.

Historically, Shaganappi Trail NW was classified as an expressway as per the 1970 Shaganappi Trail Functional Planning Study. The study recommended a major systems interchange at the junction of 16 Avenue NW, Bowness Road NW, Memorial Drive NW, and Shaganappi Trail NW. It also recommended that Shaganappi Trail NW be extended across the Bow River through Edworthy Park to connect to Sarcee Trail NW.

In 2009, Calgary City Council (Council) approved the Calgary Transportation Plan (CTP). It reclassified Shaganappi Trail NW as an Arterial Street between Crowchild Trail NW and Bowness Road NW, and identified the corridor as a primary route for transit, cycling and high occupancy vehicles (HOV). In addition, the CTP confirmed that the Bow River crossing is no longer part of the transportation network.

A South Shaganappi Area Study Plan completed in 2011 recommended that The City of Calgary undertake a corridor study because of the change in direction provided by the CTP. As a result, the Shaganappi Trail Corridor and HOV Study was undertaken, and its recommendations were approved by Council in 2015. The study was designed to address the long term plan for Shaganappi Trail NW between Stoney Trail NW and Bowness Road NW. However, during the study process, it was determined that the south junction of the study area required a unique approach with complex considerations to address including community connections, redevelopment opportunities and infrastructure design requirements. As such, The City removed the south segment between Bowness Road NW and north of 16 Avenue NW from the Shaganappi Trail Corridor and HOV Study and chose to address this segment through a separate planning study, The South Shaganappi Study.

The South Shaganappi Study was initiated in Summer 2015, and established a clear process for working with a diverse range of community stakeholders to determine the best means of addressing the challenges and opportunities associated with the area. Both short term investments and a long term plan were developed that accommodate all modes of transportation and align the study area with the CTP.

The South Shaganappi Study Area is shown in **Figure 1.1**. It is noted that the study area is entirely within the North West (NW) quadrant of The City, and as such, road names further referenced within this report do not include the quadrant identifier.

SOUTH SHAGANAPPI STUDY

Introduction



Figure 1.1: South Shaganappi Corridor Study - Study Area

1.1 STUDY PURPOSE AND OBJECTIVES

The goals of the South Shaganappi Study were:

1. **Review and recommend infrastructure that aligns the future corridor plans for Shaganappi Trail with the 2009 Calgary Transportation Plan, the Municipal Development Plan, and adjacent land uses.**
2. **Identify what land will no longer be required for transportation infrastructure.**

Seven study objectives were then developed based on community input and technical review. These objectives were utilized to evaluate and select the preferred concept option.

- Address safety for those who use and/or live by the corridor;
- Address accessibility across and throughout the corridor, reconnecting the adjacent communities of Montgomery and Parkdale / Point McKay;
- Accommodate all modes of transportation including walking, cycling, driving, HOV (high-occupancy vehicles), and transit;
- Move people and goods in an efficient way, providing continuous traffic flow and a reduction in greenhouse gas emissions;
- Preserve and enhance land within the study area where there are opportunities;
- Reflect the values and priorities of the community; and
- Develop an affordable and cost-effective solution that provides good value for money.

SOUTH SHAGANAPPI STUDY

Introduction

1.2 PREVIOUS RELATED STUDIES

The section outlines the relevant studies, policies, and plans that informed the approach taken for the South Shaganappi Study.

Transportation Corridor Study Policy (2014)

This policy document provides guidance regarding how The City undertakes Transportation Corridor Studies with emphasis on best practices of communication and engagement. This policy was utilized to establish the project process, inclusive of engagement and participation opportunities for stakeholders. This process is discussed in greater detail in **Section 2.0**.

Interim Transportation Corridor Study Guidelines (2014)

This document provides a complementary set of guidelines to the Transportation Corridor Study Policy with a focus on how to involve stakeholders early in the process, incorporate their input at key points throughout the project, and report back to stakeholders on how their input was integrated, or explain why it was not.

Shaganappi Trail Corridor Study (1970)

A functional planning study prepared by The City was completed in 1970 that reviewed Shaganappi Trail between Sarcee Trail and Bow Trail SW. The study recommended a major multi-level fully directional systems interchange at the junction of 16 Avenue, Bowness Road, Memorial Drive, and Shaganappi Trail. In order to provide access to Sarcee Trail, the study recommended Shaganappi Trail be extended across the Bow River through Edworthy Park.

The recommended plan for the study area as per the 1970 Corridor Plan is shown in **Figure 1.2**.



Figure 1.2: 1970 Shaganappi Trail Corridor Study Plan

SOUTH SHAGANAPPI STUDY

Introduction

Calgary Transportation Plan (CTP) (2009)

The CTP provides policy direction on multiple aspects of the city's transportation system. It provides an emphasis on multiple modes of transportation for Calgarians to move around the city. It also provides road classifications, and primary networks of movement for Goods, Bicycles, and Transit. The study area as identified within the CTP is shown in **Figure 1.3, Figure 1.4, Figure 1.5, Figure 1.6, and Figure 1.7.**

The 2009 CTP classified Shaganappi Trail into an Arterial Street and confirmed that the Bow River crossing of Shaganappi Trail is no longer part of the Transportation Network.

South Shaganappi Communities Area Plan (2011)

This plan encompasses the neighbourhoods of Varsity, Montgomery, University of Calgary, Banff Trail, University Heights, St. Andrew's Heights, Parkdale, and Point McKay, and was prepared to shape employment, housing, retail services, community facilities and services, transportation, supporting infrastructure, and protection of the environment. The plan set forth a recommendation to undertake a corridor study for Shaganappi Trail to assess opportunities for enhancing walking, cycling, transit, HOV, green infrastructure, and future land uses as a result of the reclassification of Shaganappi Trail from a Skeletal Road to an Arterial Street.

Shaganappi Trail Corridor and HOV Study (2014)

The City undertook the Shaganappi Trail Corridor and HOV Study as a result of the recommendation from the South Shaganappi Communities Area Plan. It was approved by Council in 2015. This study was intended to address both the north and south limits of Shaganappi Trail. Complexity at the south limit of the study area included community connections, potential land repurposing opportunities, and existing infrastructure based on the 1970 Shaganappi Trail Corridor Study. Thus, the south end of Shaganappi Trail was separated into its own corridor study.

Additional relevant plans, studies, and policies considered included:

- Crowchild Trail Corridor Study (2017)
- Montgomery Area Redevelopment Plan (2017)
- North Crosstown BRT Functional Plan Report (2016)
- Step Forward: A strategic plan for improving walking in Calgary (2016)
- Calgary Cancer Project Transportation Impact Assessment Report (2015)
- Trinity Hills Development Transportation Impact Assessment (2015)
- Complete Streets Policy (2014)
- Complete Streets Guide (2014)
- West Campus Outline Plan (2014)
- West Campus Transportation Impact Assessment (2013)
- Stadium Shopping Centre Area Redevelopment Plan (2013)
- Stadium Shopping Centre Transportation Impact Assessment (2013)
- Parkdale Neighbourhood Activity Centre Area Redevelopment Plan (2013)
- 2020 Sustainability Direction (2013)
- Cycling Strategy (2011)
- Municipal Development Plan (2009)
- Parkdale Special Planning Study (2004)
- Calgary Pathway & Bikeway Plan (2000)

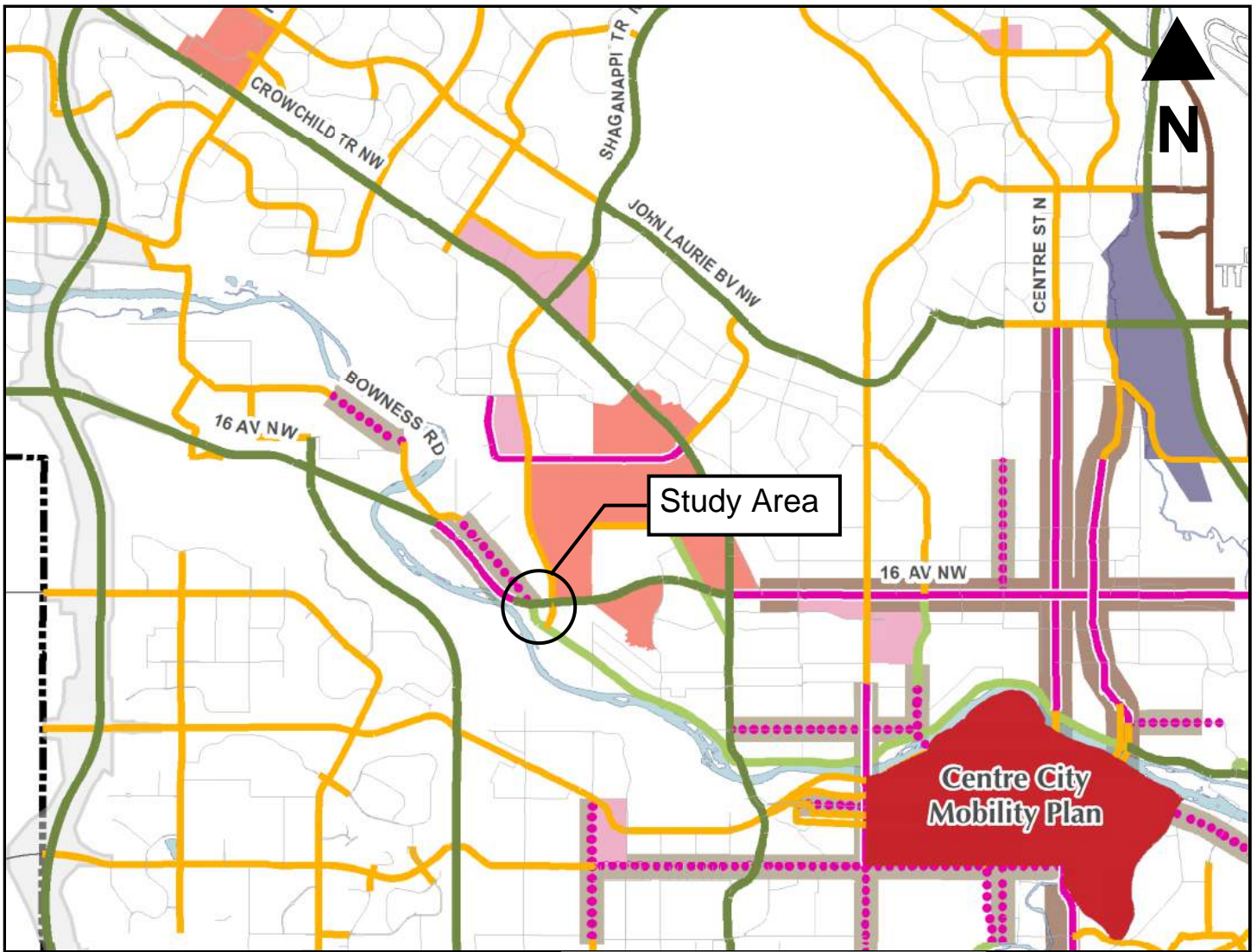

Road and Street Network

- Skeletal Road
- Arterial Street
- Industrial Arterial
- Urban Boulevard
- Neighbourhood Boulevard
- Parkway
- Roadway within City Limits
(To be classified through future Local Area Plans)
- Roadway outside City limits
- Collector Roads
- ➔ Connection to Route in Region





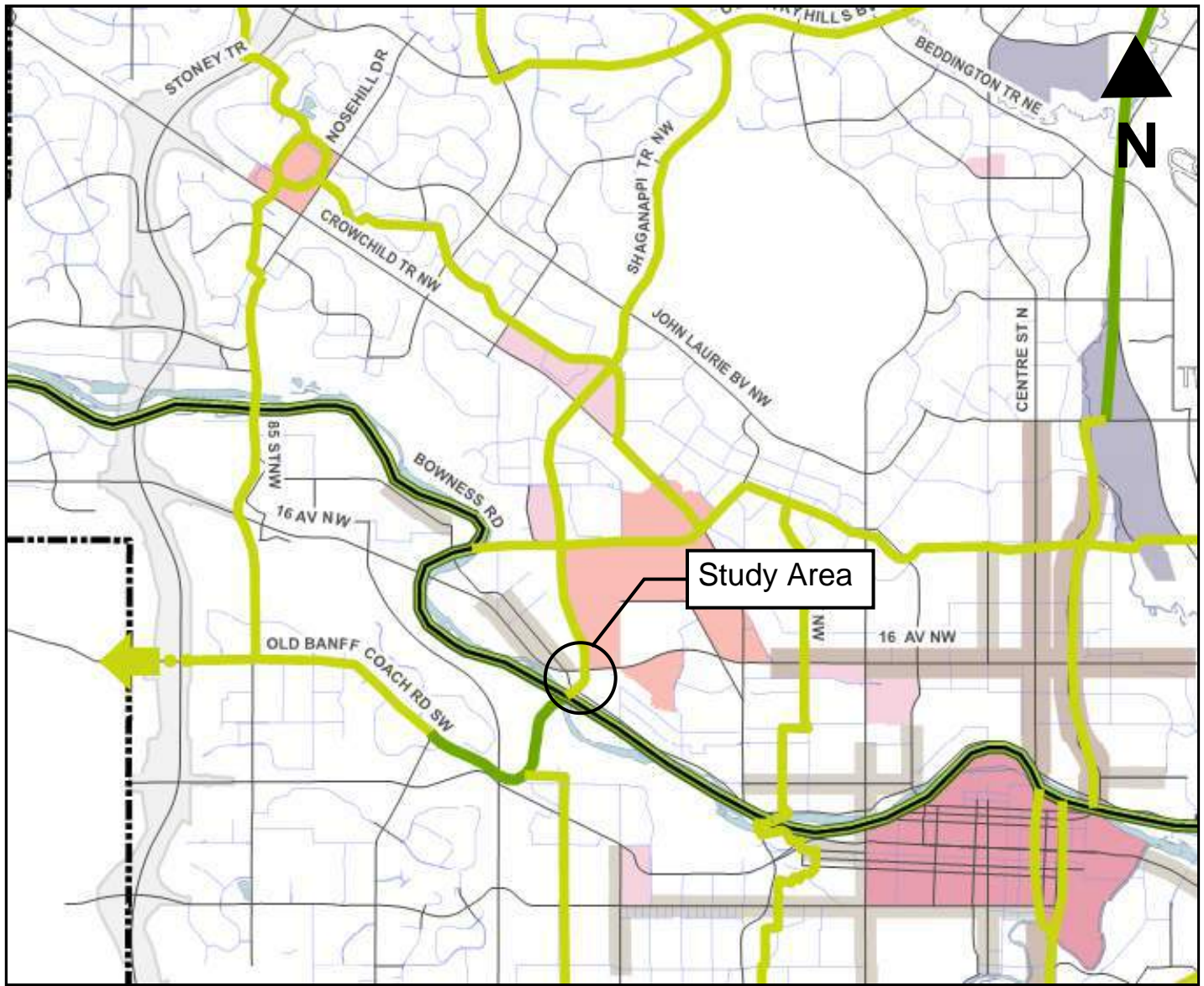

Urban Structure

- Centre City
- Major Activity Centre
- Community Activity Centre
- Urban Corridor
- Neighbourhood Corridor
- Unplanned Greenfield
- Industrial Employee Intensive
- Transportation/Utility Corridor
- City Limits

Figure 1.3 - CTP Road Classifications in Study Area



Primary Cycling Network

-  Primary Bike Route
-  Primary Bike Route dependent on land use
-  Regional Multi-Use Pathway Route (Both sides of river)*
-  Regional Multi-Use Pathway Route
-  Connection to Route in Region
-  Transportation/Utility Corridor
-  City Limits

Urban Structure

-  Centre City
-  Major Activ
-  Community Activity Centre
-  Urban Corridor
-  Neighbourhood Corridor
-  Unplanned Greenfield
-  Industrial Employee Intensive
-  Transportation/Utility Corridor
-  City Limits

Figure 1.4 - CTP Primary Cycling Network in Study Area

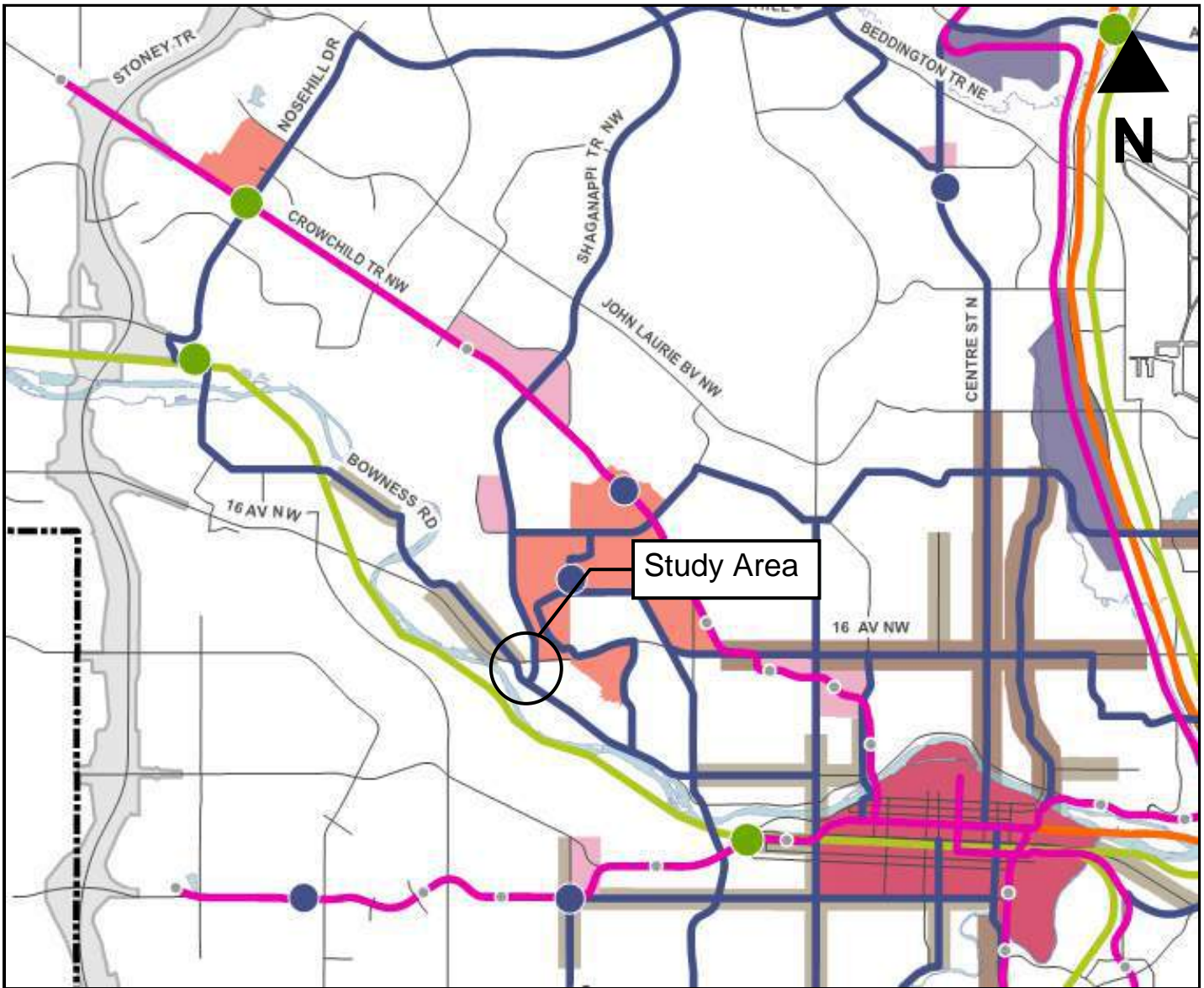

Primary Transit Network

Primary Transit Network
(Frequent, Fast, Reliable, Connected)
<10 min. Frequency, 15 hours/day, 7 days/week

- Primary Transit Network (mode to be determined based on corridor development)
- Primary Transit Network (dependent on supportive land use)
- Skeletal Light Rail Transit (LKT) Network
- Light Rail Transit (Dependent on supportive land use)
- Primary Transit Hub
- Regional/Inter-City Gateway Hub
- Transit Centres

Regional and Intercity Transit Service

- High Speed Rail Corridor
Calgary - Edmonton
- Regional Commuter Rail Corridor
- Connection to Route in Region

Urban Structure

- Centre City
- Major Activity
- Community Activity Centre
- Urban Corridor
- Neighbourhood Corridor
- Unplanned Greenfield
- Industrial Employee Intensive
- Transportation/Utility Corridor
- ⊠ City Limits

Figure 1.5 - CTP Primary Transit Network in Study Area

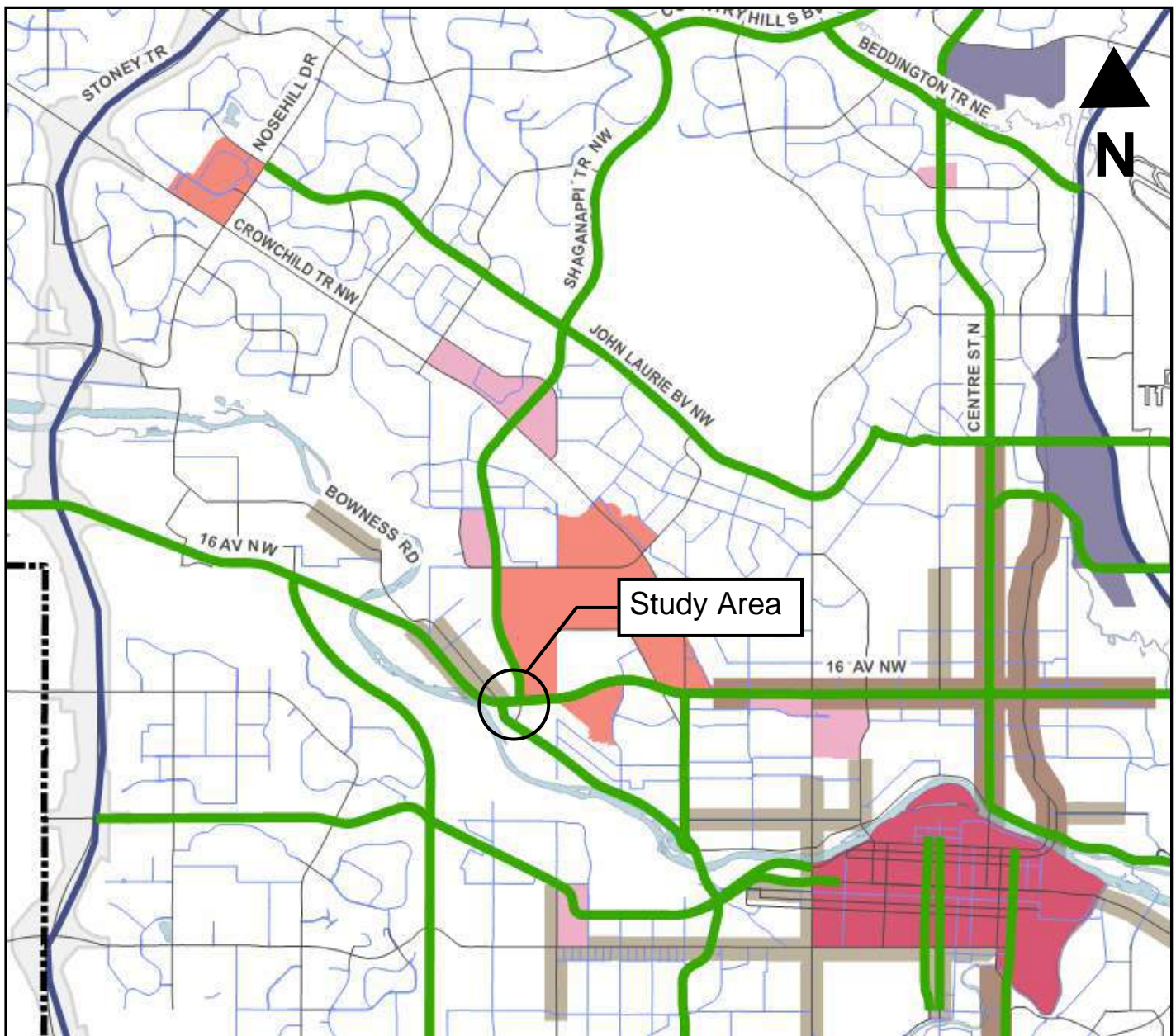

Primary HOV Network

- HOV Network (Auto and/or Transit Focus)
- Provincial HOV Network (to be confirmed with Province)

Urban Structure

- Centre City
- Major Activity
- Community Activity Centre
- Urban Corridor
- Neighbourhood Corridor
- Unplanned Greenfield
- Industrial Employee Intensive
- Transportation/Utility Corridor
- City Limits

Figure 1.6 - CTP Primary HOV Network in Study Area

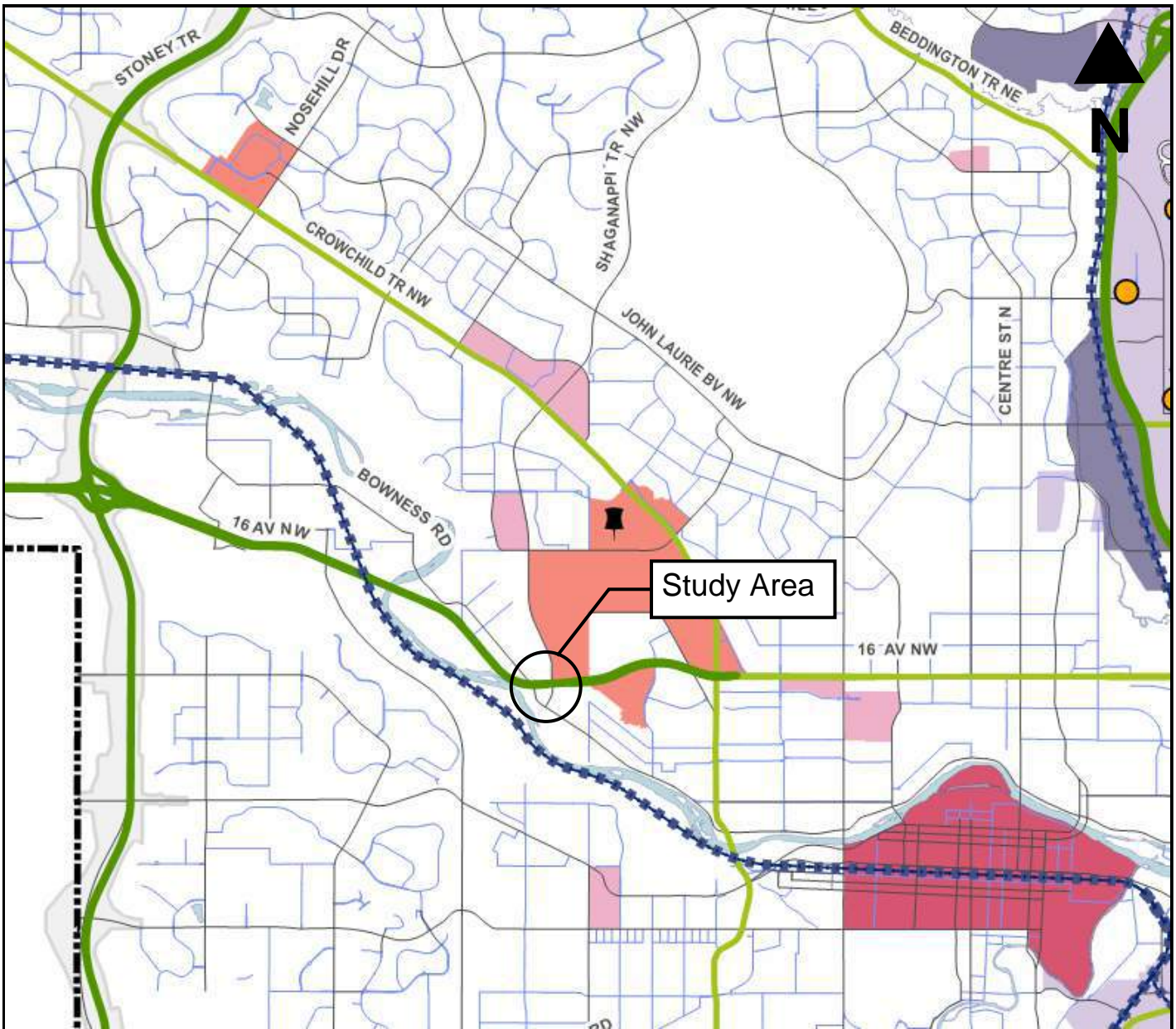

Primary Goods Movement Network

- Main Goods Movement Corridor
- Supporting Goods Movement Corridor
- - - Railway Tracks

Urban Structure

- Centre City
- Major Activity Centre
- Community Activity Centre
- Urban Corridor
- Neighbourhood Corridor
- Unplanned Greenfield
- Industrial Employee Intensive
- Transportation/Utility Corridor
- City Limits

Figure 1.7 - CTP Primary Goods Movement Network in Study Area

1.3 PROJECT PROCESS

The study was divided into three (3) primary phases running from Summer 2015 to Spring 2018 as shown in **Figure 1.8** and described between **Section 1.3.1** and **Section 1.3.5**. These phases were designed to ensure transparency, meaningful involvement, and collaboration with stakeholders.

1.3.1 Phase 1: Project Initiation and Definition

Phase 1 of the project provided area residents, businesses, and other stakeholders with an introduction to the study at an open house. Attendees were requested to provide their concerns, values, issues, and hopes for the study area. Information and input opportunities were also made available online. During this Phase, a Community Advisory Group (CAG) was formally established, whereby an introductory project meeting was held between The City and The CAG. Input collected during this phase was gathered and shared on The City's website. Relative existing technical background data was also collected during this phase.

1.3.2 Phase 2A: Concept Development

Phase 2 of the project involved reviewing public input and technical data gathered. Design Idea Workshops were held for adjacent residents of the communities and the general public to share ideas on changes in the study area. These workshops explored ways to achieve goals and objectives of the study and ideas were compiled in a "What We Heard" report available to the public. Design ideas, comments, and concerns captured in the workshop were reviewed by the project team where six common design elements were recognized. The study area was reviewed from a technical perspective during this stage, where five additional technical elements were identified. The CAG contributed to review and refinement of design and technical elements. An online survey requesting feedback on the design and technical elements was conducted to gain an understanding of the community's vision.

During this Phase, five long term concepts and a draft short term concept were presented to adjacent community residents and the public through in-person public engagement opportunities and online surveys. Feedback was gathered and presented to the public in a What We Heard report.

1.3.3 Phase 2B: Concept Analysis

Short term and long term preliminary concepts developed using study objectives established in Phase 1 were evaluated at an adjacent communities open house, a public open house and through an online survey. Feedback was gathered and presented to public in a What We Heard report and helped identify a set of draft recommended concepts to be presented to Calgarians in Phase 3.

SOUTH SHAGANAPPI STUDY

Introduction

1.3.4 Phase 3A: Preferred Concept Selection

Draft short term and long term recommended concepts were reviewed with stakeholder groups during this phase. Calgarians were invited to provide final feedback on the draft recommendations through engagement opportunities. Review of public feedback, detailed technical analysis, and refinement of draft recommended plans were completed during this stage to select final recommended plans.

1.3.5 Phase 3B: Preferred Concept Finalization

Final short term and long term recommended plans were presented to the public.

Study Timeline

Engagement Activity

Technical Design & Review



Figure 1.8: South Shaganappi Study - Study Phases

2.0 COMMUNICATIONS & ENGAGEMENT

2.1 ENGAGEMENT OVERVIEW

In conjunction with the technical analysis and design of the study area, extensive stakeholder and public engagement effort was undertaken. Feedback received through the engagement process helped the technical team evaluate and refine short and long term concepts. Stakeholder and public feedback was used to help:

- Create design and technical elements that formed the foundation for the short and long term preliminary concepts
- Refine the short term preliminary concept
- Evaluate five long term preliminary concepts
- Refine the final short term recommended concept
- Refine the final long term recommended concept

2.2 ENGAGEMENT PHASES

The study included three phases of engagement that focused on gathering stakeholder and public input to progressively inform the outcomes of the study.

2.2.1 Phase 1 – Project Initiation and Definition

Phase 1 included introductory meetings with key stakeholders and an open house to introduce the study to stakeholders and the public. This phase also included the establishment of a Community Advisory Group (CAG), a group of 17 people who represented a variety of community perspectives. The CAG worked with the technical team throughout the design process providing input and guidance on community needs.

2.2.2 Phase 2 – Concept Analysis and Development

Phase 2 included the development of design and technical elements through an iterative process that involved stakeholder and public workshops, online engagement, and technical review and analysis. These elements were then used to inform the development of one short term and five long term preliminary concepts for the study area. These preliminary concepts were presented back to stakeholders and the public for review and evaluation, resulting in the selection of one final preferred long term recommended concept, and the further refinement of the short term recommended concept.

2.2.3 Phase 3 – Preferred Concept Selection and Finalization

Phase 3 focused on evaluating and refining the short term recommended concept with the help of key stakeholders and the CAG. The feedback gathered through meetings and open houses in this phase helped the team refine and produce a final preferred short term recommended concept. The final preferred long term recommended concept was also presented to stakeholders and the public in this phase, and the team made final refinements based on the feedback received.

2.3 ENGAGEMENT ACTIVITIES

Throughout these phases a range of engagement activities were held including face-to-face meetings with key stakeholders, in-person events for stakeholders and the public, online engagement opportunities, and pop-up events in public places. These events sought input from a wide range of people including residents and businesses in adjacent and surrounding communities, those who work in and/or commute through the study area, community associations and planning committees, special interest groups, institutions, and the general public.

Throughout the course of the study, the technical team worked closely with stakeholders and the public to ensure that short and long term recommendations met the needs and vision of those who would be most impacted by the plans. This integrated and responsive approach to engagement resulted in recommended concepts that meet the study's objectives while reflecting the unique character of the communities they serve.

For a full report on the engagement process and its outcomes, please see **Appendix A**.

3.0 EXISTING CONDITIONS

Existing conditions within the study area were reviewed to help inform assessment and recommendation for both the Short Term Investments and the Long Term Concept. This section describes relevant existing conditions information for the road network, motor vehicle traffic, collision history, bridge conditions, active transportation network, transit network, deep utilities, shallow utilities and adjacent land uses.

3.1 ROAD NETWORK

The project study area includes 16 Avenue between 43 Street and West Campus Boulevard, Bowness Road between 41 Street and Shaganappi Trail, and Shaganappi Trail between Bowness Road and just north of 16 Avenue. Information outside of these limits were investigated to understand the context of the study area, but were not considered for infrastructure modifications as part of the short or long term concepts presented as part of this study.

Existing road classifications, posted speeds, and lane configurations are summarized in **Table 3-1**.

Table 3-1 - Existing Road Classifications, Geometries, and Posted Speeds

Road Segment	Street Classification	Road Geometry	Posted Speed
Shaganappi Trail	Arterial Street	Four Lane Divided Roadway	70 km/hr
16 Avenue (Crowchild Trail to 43 Street)	Skeletal Road	Four Lane Divided Roadway	70 km/hr
16 Avenue (west of 43 Street)	Urban Boulevard	Four Lane Roadway	50 km/hr
Bowness Road (16 Avenue to 42 Street)	Neighborhood Boulevard	Four Lane Roadway	50 km/hr
Bowness Road (16 Avenue to Shaganappi Trail)*	Parkway	Four Lane Roadway (inclusive of one southbound reserved transit only lane)	60 km/hr

*Southbound posted speed changes from 50km/hr to 60km/hr approximately 100m south of 16 Avenue.

Existing road geometry within the South Shaganappi study area is shown in **Figure 3.1**, **Figure 3.2**, and **Figure 3.3**, and described in further detail within **Sections 3.1.1 to 3.1.4**.

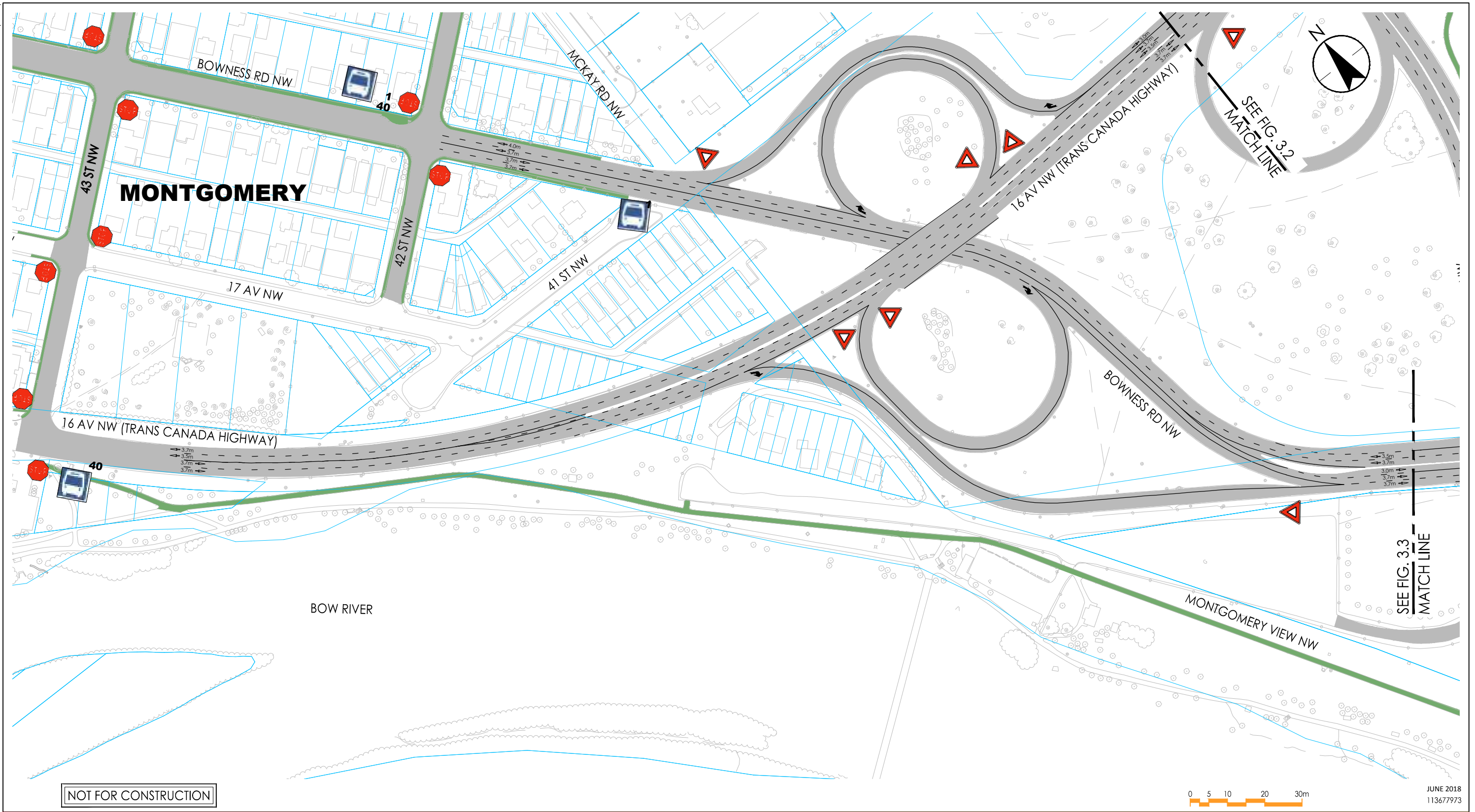

NOT FOR CONSTRUCTION



JUNE 2018
113677973



200-325 25th Street SE
Calgary AB
www.stantec.com

Legend

- EXISTING ROADWAY
- EXISTING PATHWAY/SIDEWALK
- EXISTING PROPERTY LINE
- BUS STOP
- BUS ROUTE NUMBER
- STOP SIGN
- YIELD SIGN
- TRAFFIC SIGNAL

Key Plan

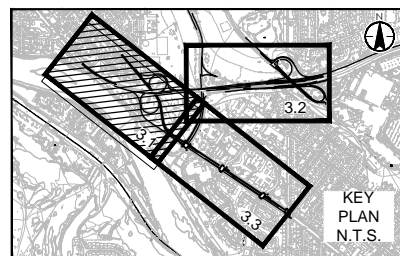

Client/Project
THE CITY OF CALGARY
SOUTH SHAGANAPPI STUDY

Figure No.
3.1

Title
EXISTING ROAD GEOMETRY
42 STREET NW TO SHAGANAPPI TRAIL NW

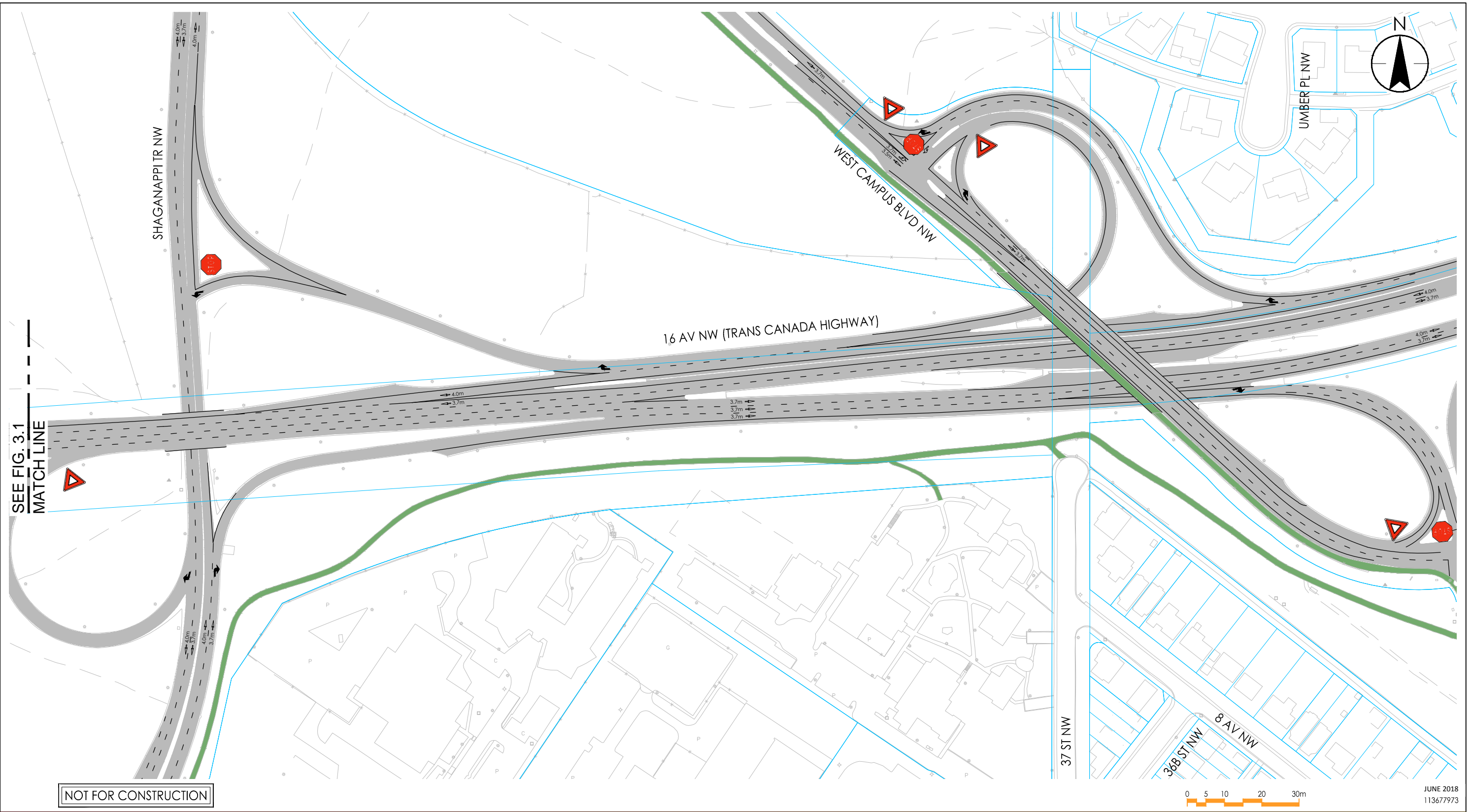

NOT FOR CONSTRUCTION



JUNE 2018
113677973



200-325 25th Street SE
Calgary AB
www.stantec.com

Legend

- EXISTING ROADWAY
- EXISTING PATHWAY/SIDEWALK
- EXISTING PROPERTY LINE
- BUS STOP
- BUS ROUTE NUMBER
- STOP SIGN
- YIELD SIGN

- TRAFFIC SIGNAL

Key Plan

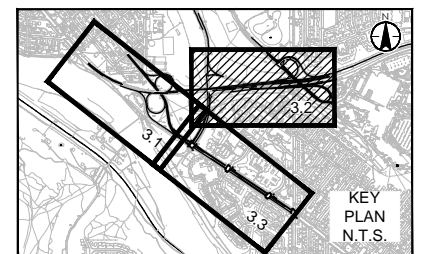

Client/Project
THE CITY OF CALGARY
SOUTH SHAGANAPPI STUDY

Figure No.
3.2

Title
EXISTING ROAD GEOMETRY
SHAGANAPPI TRAIL NW TO WEST CAMPUS
BOULEVARD NW

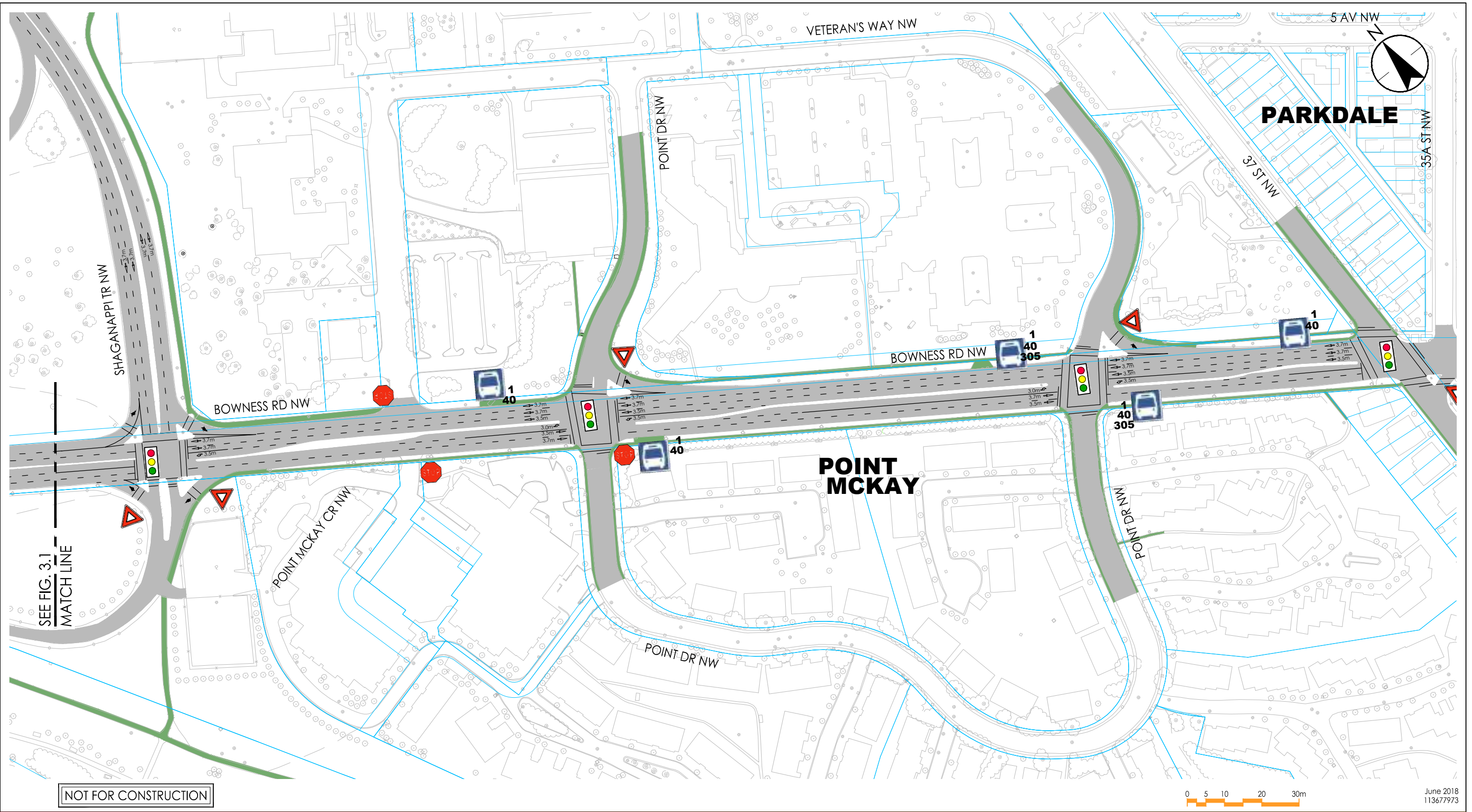

SEE FIG. 3.1
MATCH LINE

NOT FOR CONSTRUCTION











June 2018
113677973



200-325 25th Street SE
Calgary AB
www.stantec.com

Legend

-  EXISTING ROADWAY
-  EXISTING PATHWAY/SIDEWALK
-  EXISTING PROPERTY LINE
-  BUS STOP
-  BUS ROUTE NUMBER
-  STOP SIGN
-  YIELD SIGN
-  TRAFFIC SIGNAL

Key Plan

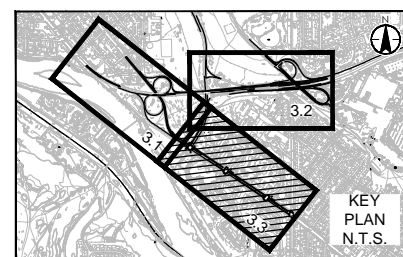

Client/Project
THE CITY OF CALGARY
SOUTH SHAGANAPPI STUDY

Figure No.
3.3

Title
EXISTING CONDITIONS

SOUTH SHAGANAPPI STUDY

Existing Conditions

3.1.1 16 Avenue Interchanges

Currently within the South Shaganappi Study area there are two existing grade separated interchanges; the 16 Avenue / Bowness Road interchange and the 16 Avenue / Shaganappi Trail interchange.

The 16 Avenue / Bowness Road interchange, as shown on **Figure 3.1**, consists of loop ramps to allow northbound Bowness Road traffic onto westbound 16 Avenue and southbound Bowness Road traffic onto eastbound 16 Avenue. Two off-ramps along 16 Avenue allow traffic to access southbound Bowness Road via eastbound 16 Avenue and northbound Bowness Road via westbound 16 Avenue.

The 16 Avenue /Shaganappi Trail interchange, as shown on **Figure 3.2**, consists of a single loop ramp to accommodate southbound Shaganappi Trail traffic onto eastbound 16 Avenue. Ramps at this interchange include an on-ramp between northbound Shaganappi Trail and eastbound 16 Avenue, and an off-ramp from westbound 16 Avenue to access both northbound and southbound Shaganappi Trail.

The existing ramp grades within the study area vary, with the steepest ramp connecting northbound Shaganappi Trail to eastbound 16 Avenue with a 6.5% slope.

3.1.2 Bowness Road and Shaganappi Trail Intersection

This signalized intersection, as shown on **Figure 3.3**, operates with two through motor vehicle travel lanes in the eastbound and westbound direction, a single dedicated eastbound left turn lane, a single dedicated westbound left turn lane, a single dedicated westbound right turn lane, and a channelized eastbound right turn lane. Shaganappi Trail consists of a shared northbound thru-left lane, a channelized northbound right turn lane, a single dedicated southbound right turn lane, a shared southbound thru-left lane, and a single dedicated southbound left turn lane.

3.1.3 Intersections Outside of the Study Area

3.1.3.1 Montgomery Main Streets Projects

During Phase 2 of the study, it was identified that consideration outside of the original project study area should be given in order to adequately consider the potential impacts of the short term modifications. This extension of the study area included Bowness Road between 41 Street and 43 Street, and 43 Street between Bowness Road and 16 Avenue.

However, during Phase 3 of the study, funding was provided for the Main Streets program to review these extents as part of the Montgomery Main Streets projects. As such, it was decided that the project limits should be returned to their original extents, and all feedback provided on Bowness Road between 41 Street and 43 Street, and 43 Street between 16 Avenue and Bowness Road be provided to the Montgomery Main Streets team.

The Montgomery Main Streets project will address short term changes to these areas.

SOUTH SHAGANAPPI STUDY

Existing Conditions

3.1.3.2 Intersections West of the Study Area

16 Avenue and 43 Street Intersection

This two-way stop-controlled intersection, as shown on **Figure 3.1**, consists of a shared through-left lane and shared through-right lane in both the eastbound and westbound direction along 16 Avenue. A single lane with shared left, through, and right turning movements in the northbound and southbound direction exists at 43 Street.

Bowness Road and 42 Street Intersection

This two-way stop controlled intersection (north-south), as shown on **Figure 3.1**, consists of a single southbound lane with shared left, through, and right turning movements on Bowness Road, and a northbound shared through-left lane and a northbound right turn lane on Bowness Road. A single lane with shared left, through, and right turning movements in the northbound and southbound directions exists at 42 Street.

3.1.3.3 Intersections East of the Study Area

Bowness Road and Point McKay Crescent Intersection

This two-way stop controlled intersection, as shown on **Figure 3.3**, operates with two westbound through lanes, a shared westbound through-right turn lane, a single eastbound through lane and a shared eastbound through-right turn lane on Bowness Road. Point McKay Crescent has a right-in right-out access onto Bowness Road.

Bowness Road and Point Drive Intersection

This signalized intersection, as shown on **Figure 3.3**, operates with three westbound through lanes, a westbound left turn lane, a westbound right turn lane, an eastbound through lane, an eastbound left turn lane, and a shared eastbound through-right turn lane on Bowness Road. Point Drive has a shared through-left turn lane and a right turn lane in the northbound and southbound directions.

Bowness Road and Veterans Way / Point Drive Intersection

This signalized intersection, as shown on **Figure 3.3**, operates with three westbound through lanes, a westbound left turn lane, a westbound right turn lane, an eastbound through lane, an eastbound left turn lane, and a shared eastbound through-right turn lane on Bowness Road. Veterans Way has a southbound through-left turn lane and a southbound right turn lane. Point Drive has a single northbound left-through-right turn lane.

Bowness Road and 37 Street Intersection

This signalized intersection, as shown on **Figure 3.3**, operates with a shared through-left turn lane and shared through-right turn lane in the westbound and eastbound directions on Bowness Road. 37 Street has a shared northbound through-left turn lane, a northbound right turn lane, and a single southbound shared left-through-right turn lane. Immediately west of the intersection, a third westbound through lane is introduced on Bowness Road.

In 2017, a new left turn bay was constructed in the eastbound direction to improve traffic operations at this intersection.

3.2 CURRENT TRAFFIC VOLUMES AND OPERATIONS

Traffic volumes within the study area were collected on June 16 – June 18, 2015. These traffic volumes were assessed to understand existing traffic operations. The existing 2015 AM and PM peak hour motor vehicle volumes, pedestrian volumes, and bicycle volumes are shown in **Figure 3.4**, **Figure 3.5**, and **Figure 3.6**, respectively. An analysis of traffic operating conditions was undertaken for the study area using the Synchro and VISSIM 7.00-07 software package. The detailed analysis undertaken is provided in **Appendix B**.

Although the intersections within the study area are operating at an acceptable overall intersection level of service, Bowness Road from Shaganappi Trail to 37 Street experiences queuing. The Bowness Road / Shaganappi Trail intersection experiences delays and queuing during both the AM and PM peak hours.

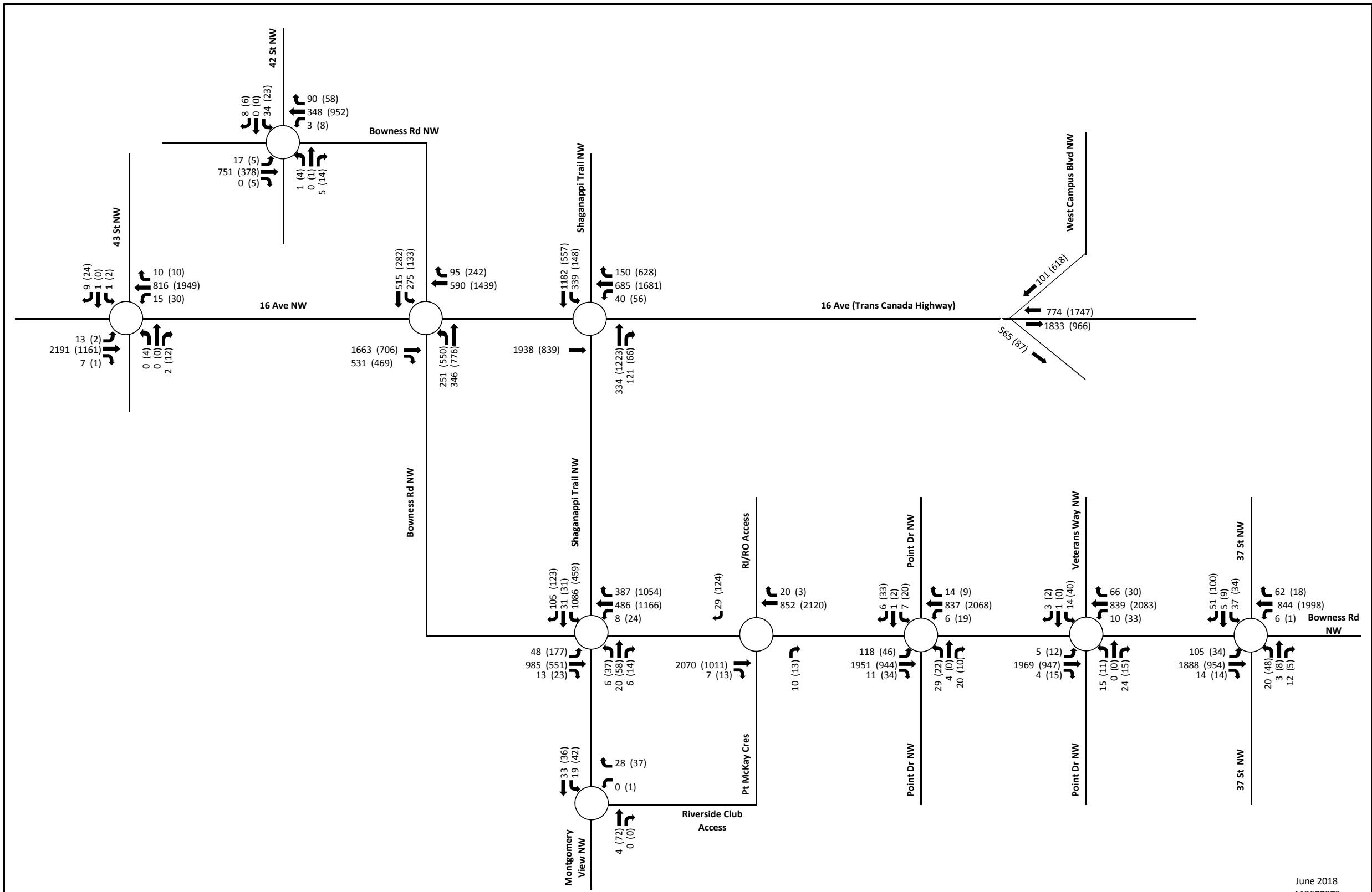

June 2018
113677973



200 - 325 25th Street SE
Calgary, AB T2A 7H8
www.stantec.com

Legend

xxx (xxx) AM (PM) PEAK HOUR TRAFFIC VOLUMES

Note: Traffic counts were conducted on June 16-18, 2015

Client/ Project

**THE CITY OF CALGARY
SOUTH SHAGANAPPI STUDY**

Figure No.

3.4

Title

2015 TRAFFIC VOLUMES

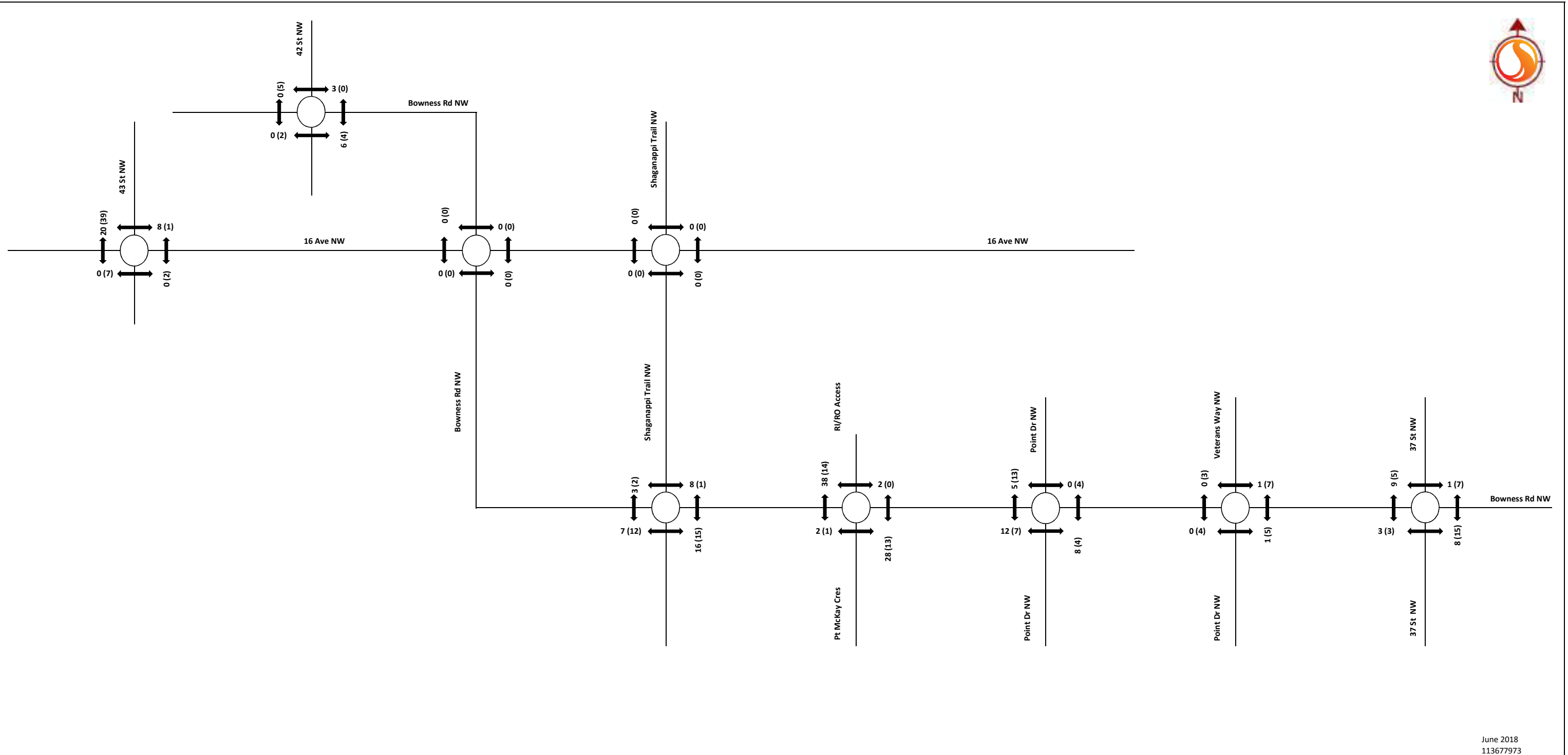

June 2018
113677973



200 - 325 25th Street SE
Calgary, AB T2A 7H8
www.stantec.com

Legend

xxx (xxx) AM (PM) PEAK HOUR PEDESTRIAN VOLUMES

Note: Traffic counts were conducted on June 16-18, 2015

Client/ Project _____

**THE CITY OF CALGARY
SOUTH SHAGANAPPI STUDY**

Figure No. _____

3.5

Title _____

2015 PEDESTRIAN VOLUMES

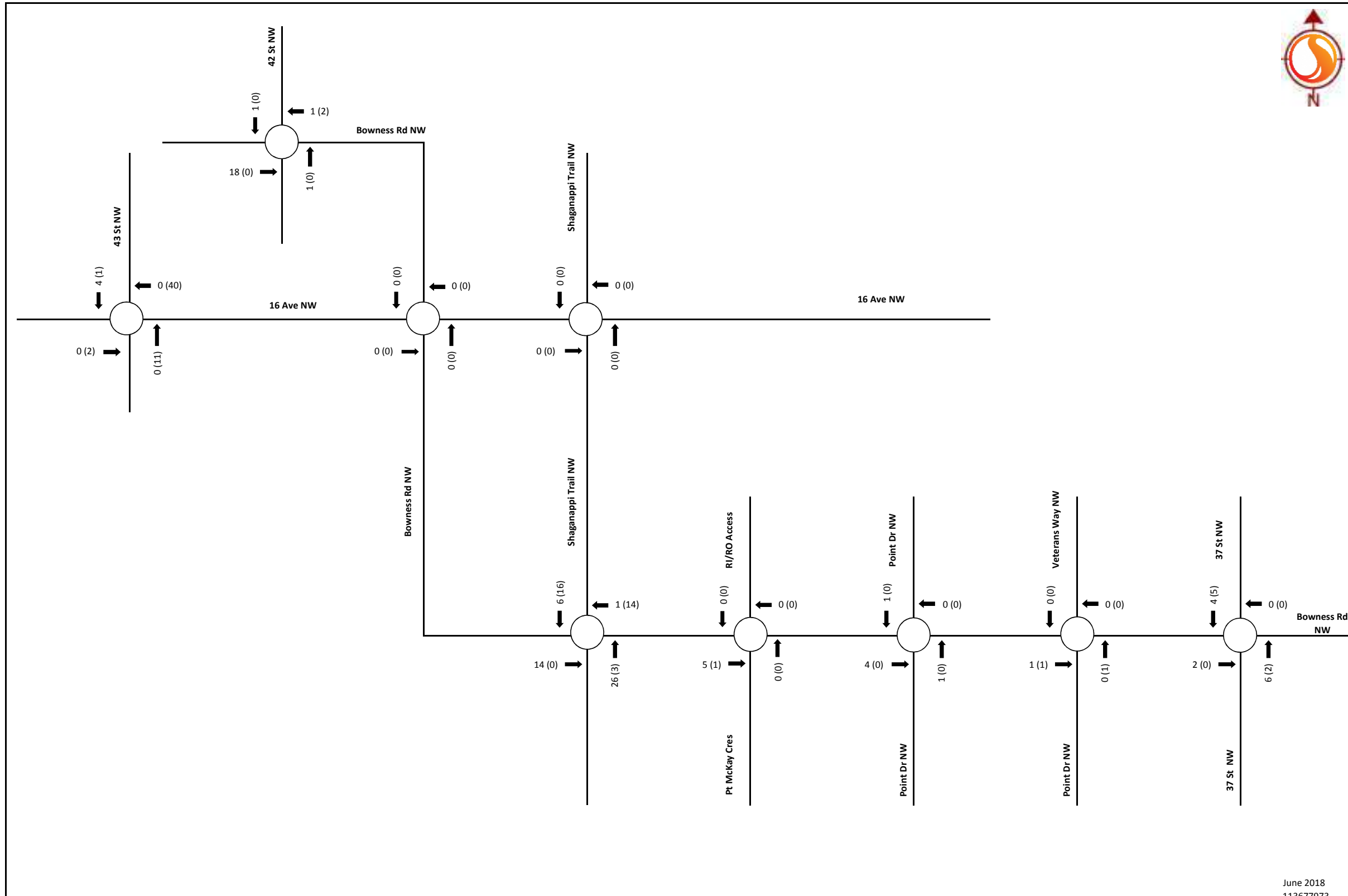

June 2018
113677973



Legend

xxx (xxx) AM (PM) PEAK HOUR BICYCLES VOLUMES

Note: Traffic counts were conducted on June 16-18, 2015

Client/ Project
**THE CITY OF CALGARY
SOUTH SHAGANAPPI STUDY**

Figure No.
3.6

Title
2015 BICYCLE VOLUMES

SOUTH SHAGANAPPI STUDY

Existing Conditions

3.3 COLLISION REVIEW

Collision history of the study area for the period of 2010 to 2014 was analyzed. During this period, there were 415 collisions.

Contributing factors for collisions at 16 Avenue and Shaganappi Trail ramps, as recorded in the collision reports, included inadequate geometry for traffic control including:

- High approach speed which results in abrupt braking, and
- Low approach angle which makes the task of observing traffic ahead and searching for a gap very complex.

A detailed collision review memo is provided in **Appendix C**.

3.4 BRIDGE CONDITIONS

There are two existing bridges within the South Shaganappi study area: the 16 Avenue bridge crossing of Bowness Road and the 16 Avenue bridge crossing of Shaganappi Trail.

The existing structures were originally built in 1960 and have since undergone several rehabilitations, with the most recent one completed in 2012. The expected remaining life of the structures based on evaluation undertaken in 2011 was 35 years. As such, the bridges could remain in service until 2046 under the current conditions with typical general maintenance and minor rehabilitations. Beyond the 35-year service life, major rehabilitation would be required.

A detailed bridge conditions memo is provided in **Appendix D**.

3.5 ACTIVE TRANSPORTATION NETWORK

The existing active transportation network is shown in **Figure 3.7**. Existing bicycle routes connect to the regional pathway system and connect communities north of the river including Montgomery, Parkdale, Point McKay, and St. Andrews Heights. South of the river, the regional pathway connects through Edworthy Park to bicycle lanes and signed routes connected to the communities of Wildwood and Spruce Cliff. Communities divided by the Bow River connect along the regional pathway via the Harry Boothman Bridge.

Some of the active transportation facilities that connect these communities include:

- Regional Pathways
- Signed bicycle routes that are shared with automobiles
- Local pathways

Existing conditions within the study area indicate significant activity along the Bow River Pathway and Bowness Road, however, limited activity exists within the rest of the study area where there is separation created by physical barriers.

A detailed account of the existing active transportation network is provided in **Appendix E**.

SOUTH SHAGANAPPI STUDY

Existing Conditions



Figure 3.7: Existing Active Transportation Network

3.6 TRANSIT

Bowness Road and Shaganappi Trail have both been identified on the Primary Transit Network within the Calgary Transportation Plan (CTP). The existing transit routes, average weekday ridership, and current bus headways are summarized in **Table 3-2**.

SOUTH SHAGANAPPI STUDY

Existing Conditions

Table 3-2 - Existing Bus Service Summary

Bus Route	Average Weekday Ridership (people/day)	Current Headways
Route 1 – Bowness/Forest Lawn	10,042	10 Minutes (peak period) 12 – 18 Minutes (off peak period)
Route 40 – Crowfoot/North Hill	1,025	35 Minutes
Route 91 – Lions Park/Brentwood	990	17 Minutes (peak period) 25 Minutes (off peak period)
Route 305 BRT – Bowness/17 Avenue SE (Peak Period Service Only)	2,166	10 Minutes (peak period)

It is noted that the 2013 Route Ahead Strategic Plan for public transit in Calgary identifies that upgrades to Route 305 Bus Rapid Transit (BRT): West should be made with implementation of transit priority in the medium term dependent on the pace of development in the corridor and availability of capital budget. Medium term is identified as the point when Calgary reaches a population of 1.5 million people.

Future Transit Routes nearby to the study area include the North Crosstown BRT. The North Crosstown BRT provides an east-west transit connection between northeast and northwest Calgary, operating between Saddletowne LRT Station and Brentwood LRT Station. Nearest to the South Shaganappi Study Area, the BRT Route runs north from 16 Avenue along West Campus Boulevard, with a planned station along West Campus Boulevard. BRT construction commenced in Summer of 2017 with service anticipated to commence in 2018. Service will be provided seven days a week with buses running every 10 minutes during peak hours (6:30-9 am & 3-6 pm). As ridership grows, the BRT will operate seven days a week, 15 hours per day with buses running every 10 minutes.

3.7 ADJACENT LAND USE

Adjacent land uses include multiple inner city and established residential areas including the communities of Varsity, Parkdale, Point McKay, St. Andrews Heights, University Heights, Montgomery, Banff Trail, Wildwood, and Spruce Cliff. Employment and commercial corridors along the Trans-Canada Highway are also located within the study area.

Multiple neighbourhood activity centres, major activity centres, and a community activity centre surround the corridor area. These include the Alberta Children’s Hospital, Foothills Hospital, the Tom Baker Cancer Centre, Market Mall, The University of Calgary, McMahon Stadium, University Innovation Park, and West Campus.

SOUTH SHAGANAPPI STUDY

Existing Conditions

Parks and open spaces in the area include Shouldice Park and Edworthy Park. The Bow River ravine system and escarpment as well as regional and local pathways are also within in the study area.

3.8 UTILITIES

The existing deep and shallow utility infrastructure within and adjacent to the study area are shown in **Figure 3.8** through **Figure 3.13** and documented in detail within **Appendix F**. The most important existing utility infrastructure is summarized below.

- There is an existing water pump station providing service to the northwest quadrant of The City located at the north west corner of Bowness Road and Veterans Way. It is noted that this water pump station does not meet future demands, and therefore, a new water pump station has been proposed for construction at the south west corner of Bowness Road and Shaganappi Trail.
- A 1950mm concrete pipe watermain runs beneath 16 Avenue, east of 43 Street, where it then crosses 16 Avenue and continues southeast beneath Montgomery View, following further southeast past the Bowness Road / Shaganappi Trail intersection.
- A 525 concrete sanitary sewer crosses Shaganappi Trail immediately south of the 16 Avenue / Shaganappi Trail interchange, where it then heads south along southbound and northbound Shaganappi Trail.
- A 1200 x 1650 concrete storm duct crosses Bowness Road approximately 150m south of the 16 Avenue / Bowness Road interchange. A 1200 x 1650 concrete storm duct crosses Montgomery View at the Bow River Pathway. A 1200 x 1650 concrete storm duct and 900 mm concrete storm sewer cross Shaganappi Trail approximately 150m south of the 16 Avenue / Shaganappi Trail interchange.
- Shallow utilities consist of power, gas, and telecommunication facilities. Above grade power and communication facilities include power poles transformers, cabinets, and communication pedestals. Below grade facilities consist of buried concrete boxes and ducts through which power, gas and telecommunication facilities are located. Set depths for buried facilities typically range between 0.7 to 1m in depth, though changes to surface elevations since original install can result in facilities residing at non-standard depths.

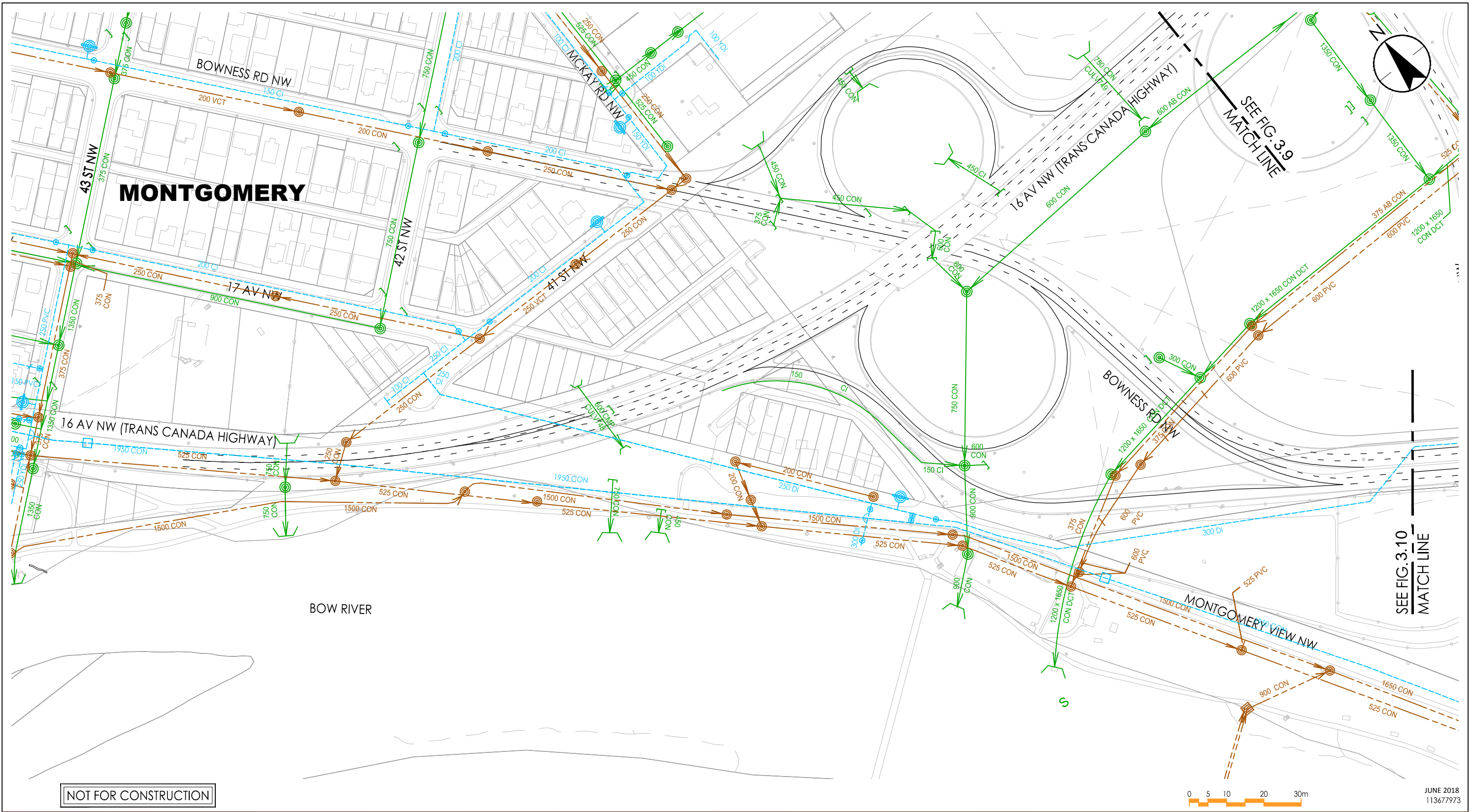

200-325 25th Street SE
Calgary AB
www.stantec.com

Legend

- EXISTING STORM LINE
- EXISTING SANITARY LINE
- EXISTING WATER LINE
- STORM MANHOLE
- SANITARY MANHOLE
- FIRE HYDRANT
- CATCH BASIN
- CULVERT

Key Plan

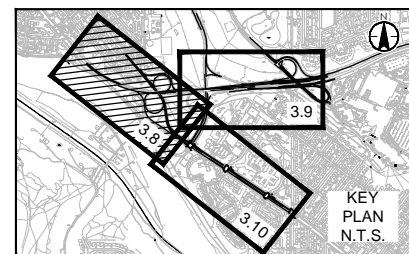

Client/Project
THE CITY OF CALGARY
SOUTH SHAGANAPPI STUDY

Figure No.
3.8

Title
EXISTING DEEP UTILITIES
42 STREET NW TO SHAGANAPPI TRAIL NW

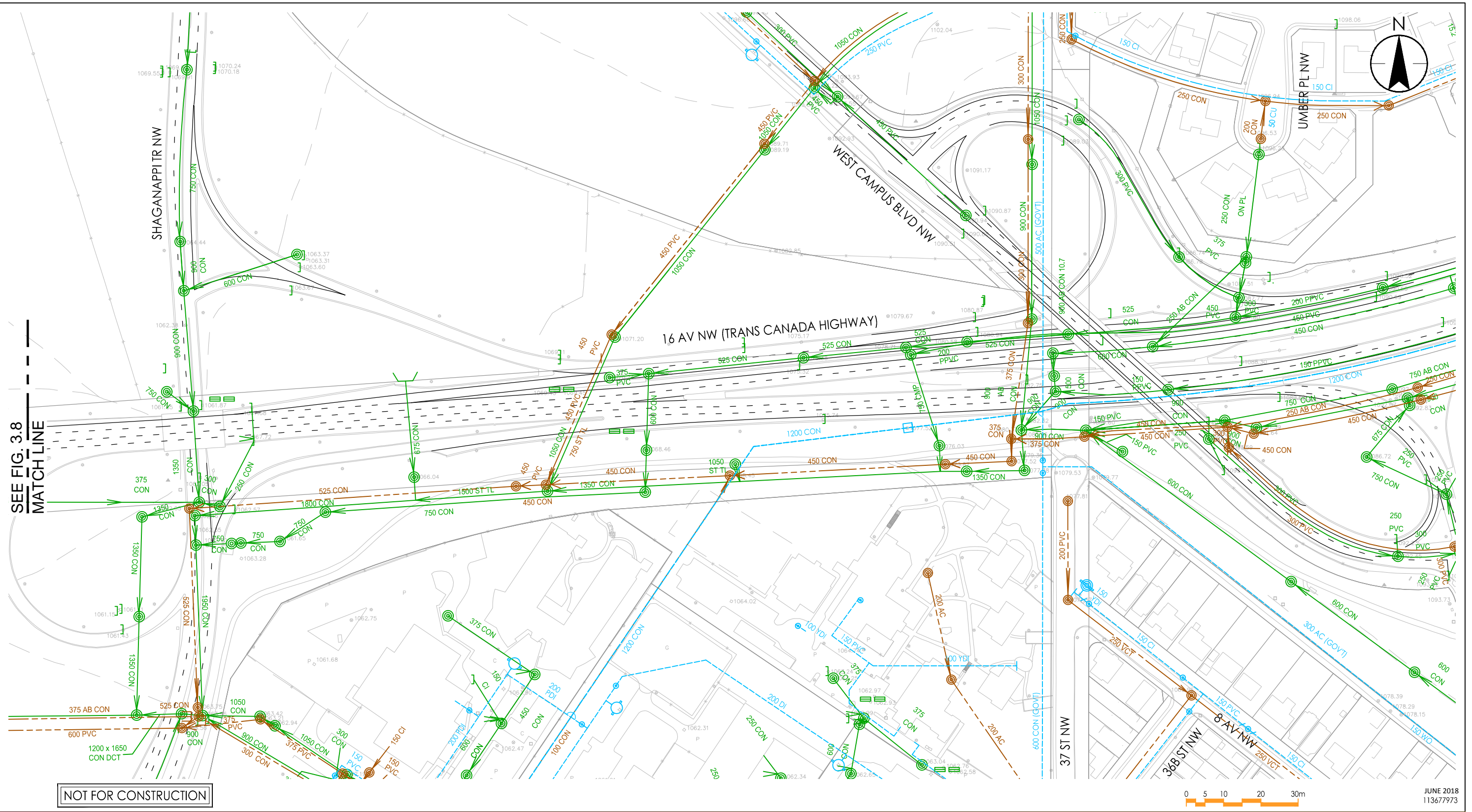

200-325 25th Street SE
Calgary AB
www.stantec.com

Legend

	EXISTING STORM LINE
	EXISTING SANITARY LINE
	EXISTING WATER LINE
	STORM MANHOLE
	SANITARY MANHOLE
	FIRE HYDRANT
	CATCH BASIN
	CULVERT

Key Plan

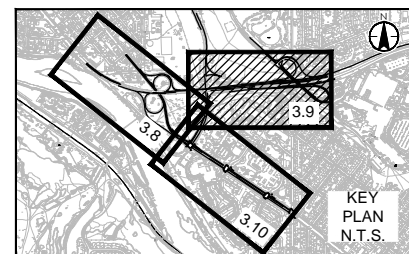

Client/Project
THE CITY OF CALGARY
SOUTH SHAGANAPPI STUDY

Figure No.
3.9

Title
EXISTING DEEP UTILITIES
SHAGANAPPI TRAIL NW TO WEST CAMPUS
BOULEVARD NW

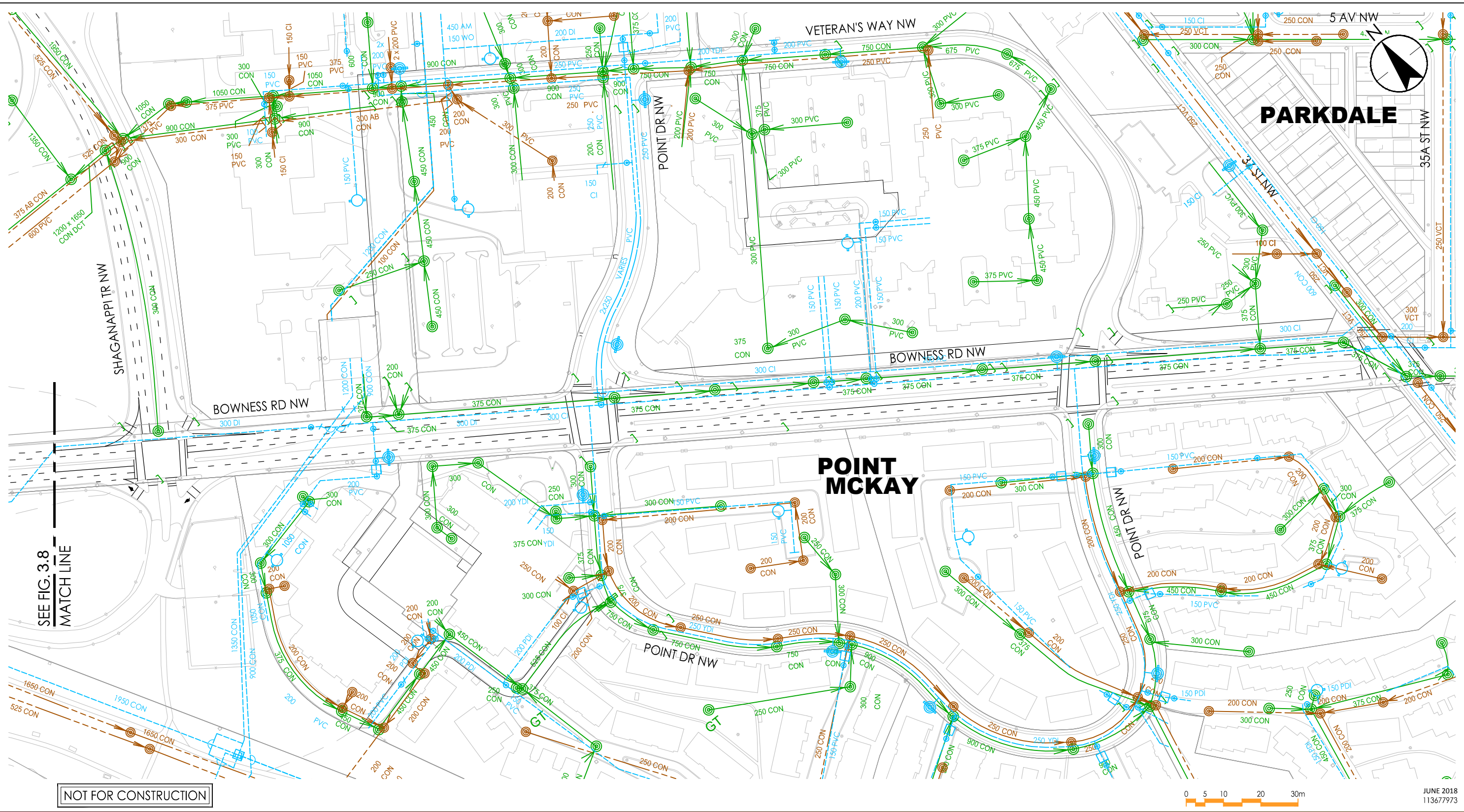

SEE FIG. 3.8
MATCH LINE

NOT FOR CONSTRUCTION



JUNE 2018
113677973



200-325 25th Street SE
Calgary AB
www.stantec.com

Legend

- EXISTING STORM LINE
- EXISTING SANITARY LINE
- EXISTING WATER LINE
- STORM MANHOLE
- SANITARY MANHOLE
- FIRE HYDRANT
- CATCH BASIN
- CULVERT

Key Plan

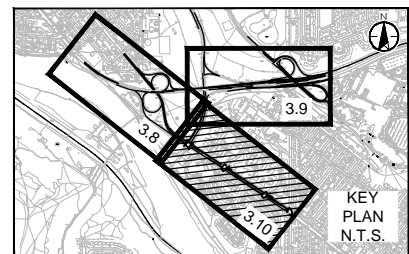

Client/Project
THE CITY OF CALGARY
SOUTH SHAGANAPPI STUDY

Figure No.
3.10

Title
EXISTING DEEP UTILITIES
SHAGANAPPI TRAIL NW TO 37 STREET NW

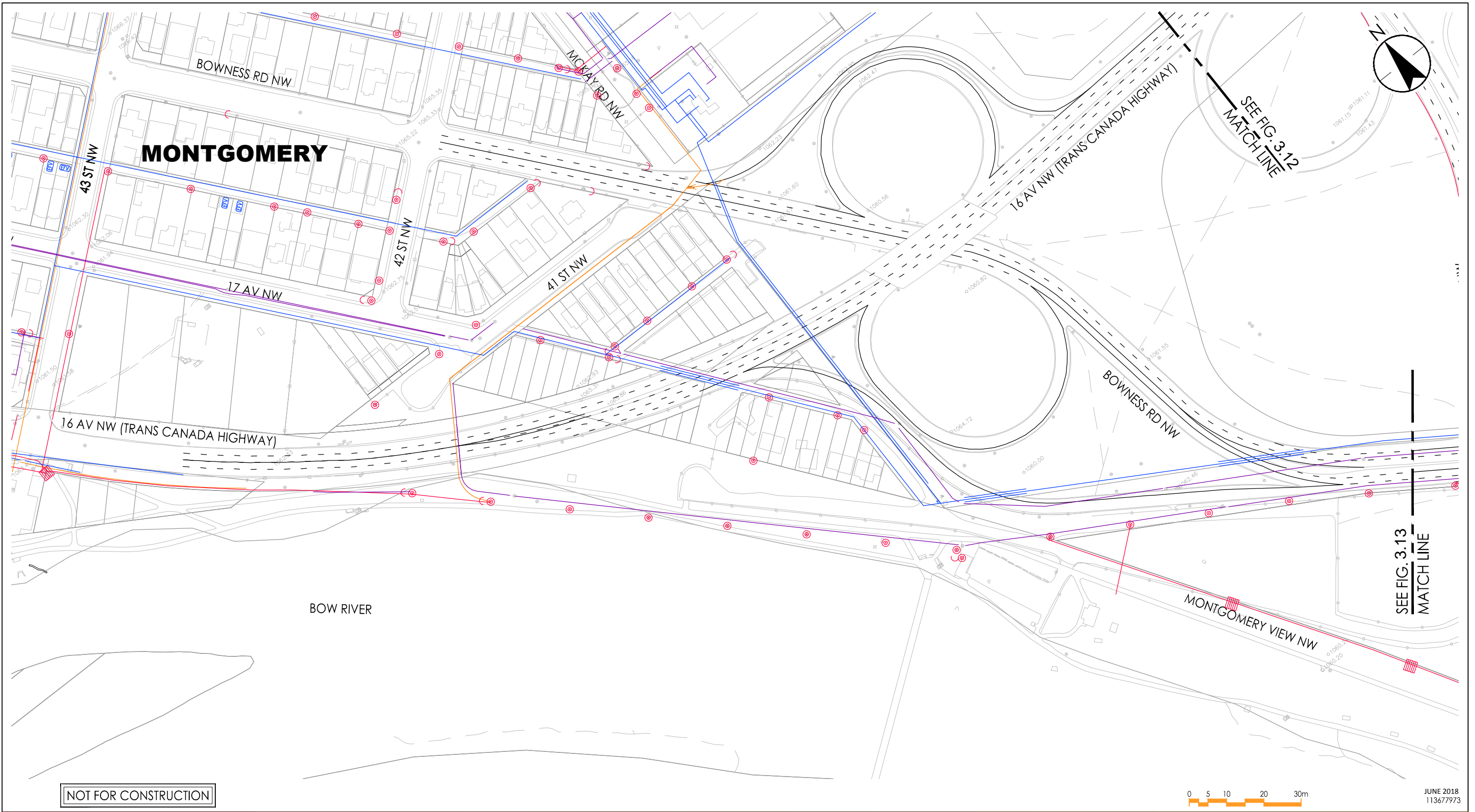

JUNE 2018
113677973



200-325 25th Street SE
Calgary AB
www.stantec.com

Legend

- EXISTING ENMAX POWER
- EXISTING SHAW LINE
- EXISTING TELUS LINE
- EXISTING ATCO GAS LINE
- POLE
- PULL BOX
- POLE AND ANCHOR
- TRANSFORMER
- ATCO GAS SYMBOL

Key Plan

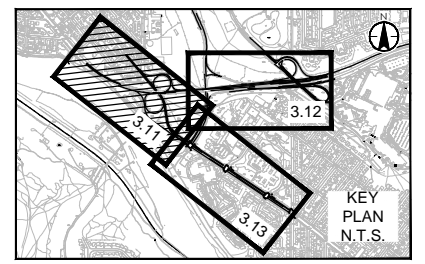

Client/Project
THE CITY OF CALGARY
SOUTH SHAGANAPPI STUDY

Figure No.
3.11

Title
**EXISTING SHALLOW UTILITIES
42 STREET NW TO SHAGANAPPI TRAIL NW**

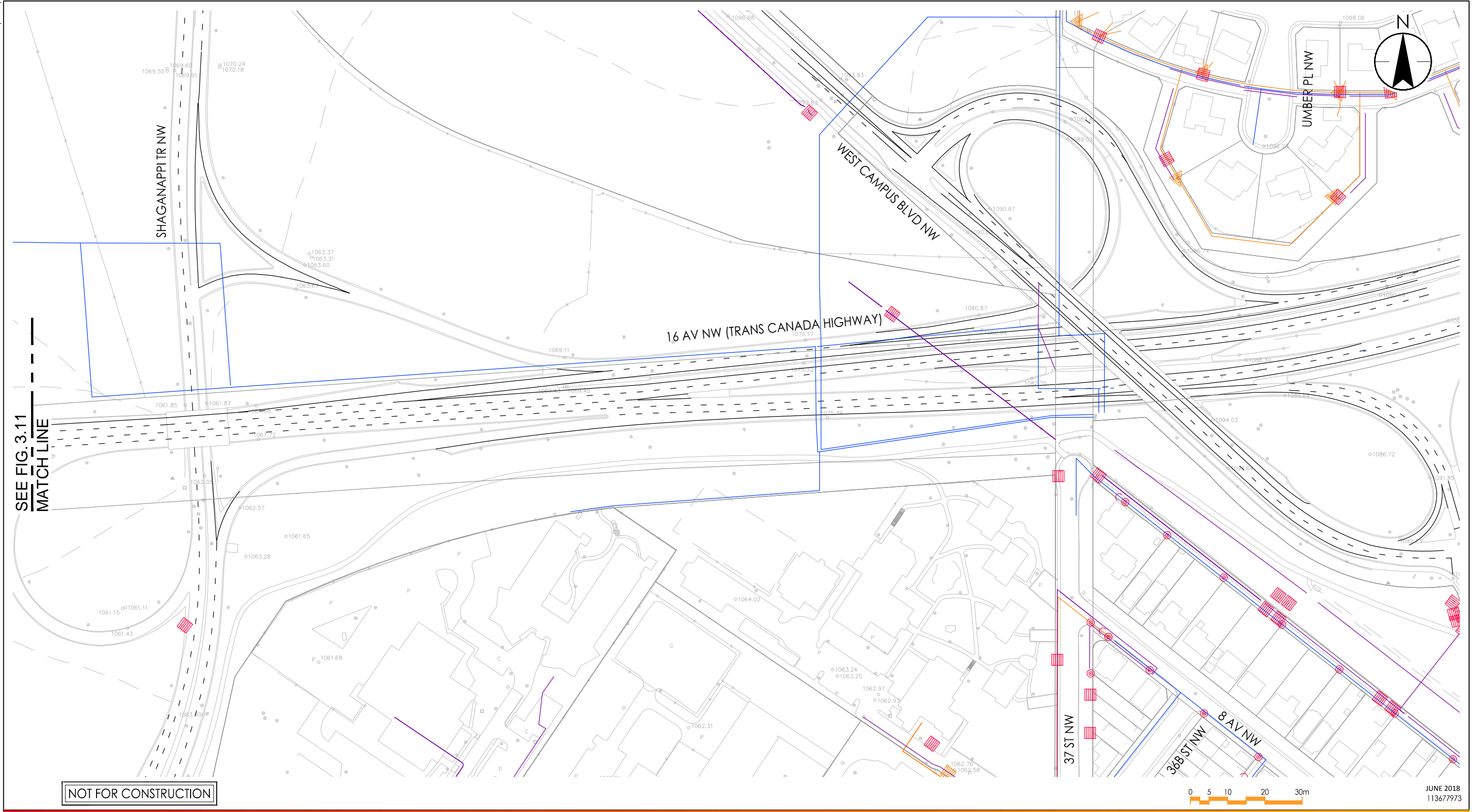

SEE FIG. 3.11
MATCH LINE

NOT FOR CONSTRUCTION

0 5 10 20 30m

JUNE 2018
113677973



200-325 25th Street SE
Calgary AB
www.stantec.com

Legend

- EXISTING ENMAX POWER
- EXISTING SHAW LINE
- EXISTING TELUS LINE
- EXISTING ATCO GAS LINE
- POLE
- PULL BOX
- POLE AND ANCHOR
- TRANSFORMER

Key Plan

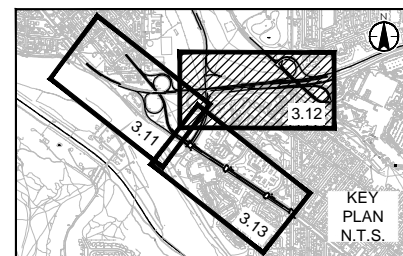

Client/Project
THE CITY OF CALGARY
SOUTH SHAGANAPPI STUDY

Figure No.
3.12

Title
EXISTING SHALLOW UTILITIES
SHAGANAPPI TRAIL NW TO WEST CAMPUS
BOULEVARD NW

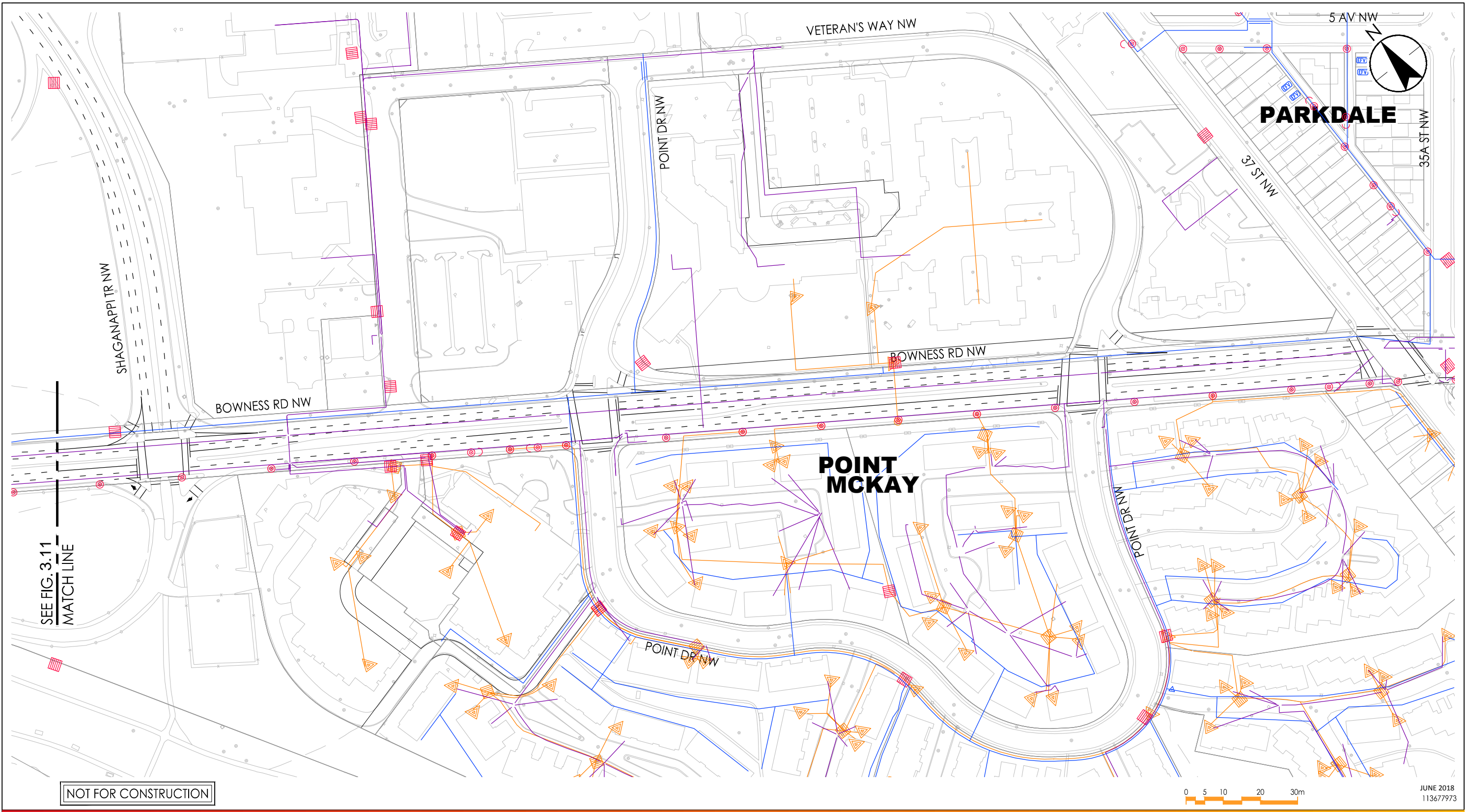

SEE FIG. 3.11
MATCH LINE

NOT FOR CONSTRUCTION

0 5 10 20 30m

JUNE 2018
113677973



200-325 25th Street SE
Calgary AB
www.stantec.com

Legend

- EXISTING ENMAX POWER
- EXISTING SHAW LINE
- EXISTING TELUS LINE
- EXISTING ATCO GAS LINE
- POLE
- PULL BOX
- POLE AND ANCHOR
- TRANSFORMER

Key Plan

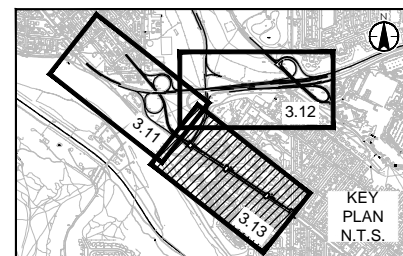

Client/Project
THE CITY OF CALGARY
SOUTH SHAGANAPPI STUDY

Figure No.
3.13

Title
EXISTING SHALLOW UTILITIES
EXISTING SHALLOW UTILITIES
SHAGANAPPI TRAIL NW TO 37 STREET NW

4.0 SHORT TERM INVESTMENT PLAN

The City's Transportation Corridor Study Policy requires the consideration for short term investments that can be made to address existing issues and fulfill opportunities within the study area being examined for long term transportation infrastructure changes.

This section describes the issues and opportunities that were identified based on the existing conditions described in **Section 3.0**, and outlines both the ideas that were evaluated as well as the final recommended short term investments within the study area.

4.1 EXISTING ISSUES AND OPPORTUNITIES

Existing issues identified through public input and technical review were grouped into three major categories: safety, motor vehicle traffic operations, and pedestrian/bicycle connectivity.

4.1.1 Safety



Figure 4.1: Collision Rate vs. City Average

4.1.2 Motor Vehicle Traffic Operations

Difficulty in making turning movements due to heavy traffic, difficulty in making turning movements due to challenging road geometry, and difficulty in making turning manoeuvres due to queueing create issues for people who drive in the study area as shown in **Figure 4.2**.

SOUTH SHAGANAPPI STUDY

Short Term Investment Plan

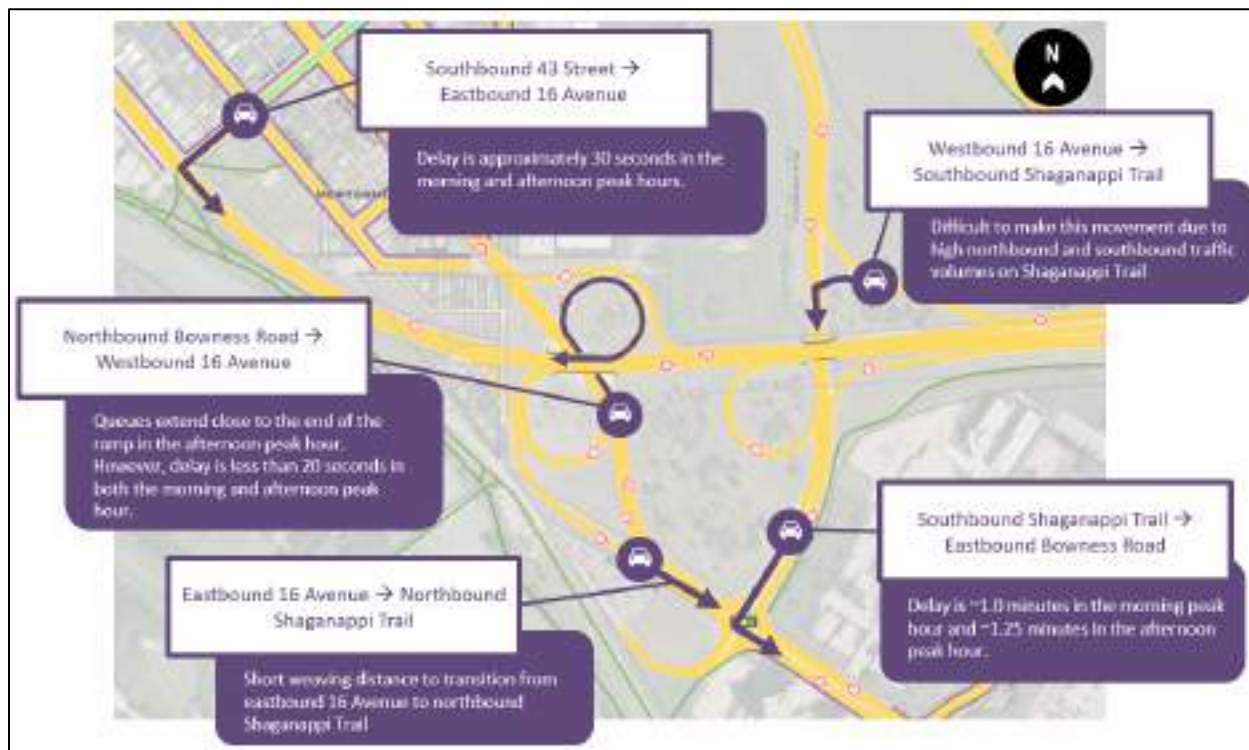

Figure 4.2: Traffic Operation Issues

Existing motor vehicle traffic operation issues identified above include:

- Northbound Bowness Road to westbound 16 Avenue queuing along the loop ramp during PM peak hours.
- Southbound Shaganappi Trail to eastbound Bowness Road traffic delays in both AM and PM peak hours.
- Southbound 43 Street to eastbound 16 Avenue delay in both AM and PM peak hours.
- Difficulty in maneuvering from westbound 16 Avenue to southbound Shaganappi Trail as a result of heavy traffic volumes on Shaganappi Trail.
- Short transition distance from eastbound 16 Avenue off ramp to northbound Shaganappi Trail.

4.1.3 Pedestrian and Bicycle Connectivity

Limited pedestrian and bicycle connectivity within the study area creates barriers for individuals who walk, roll, and bicycle as shown in **Figure 4.3**.

SOUTH SHAGANAPPI STUDY

Short Term Investment Plan

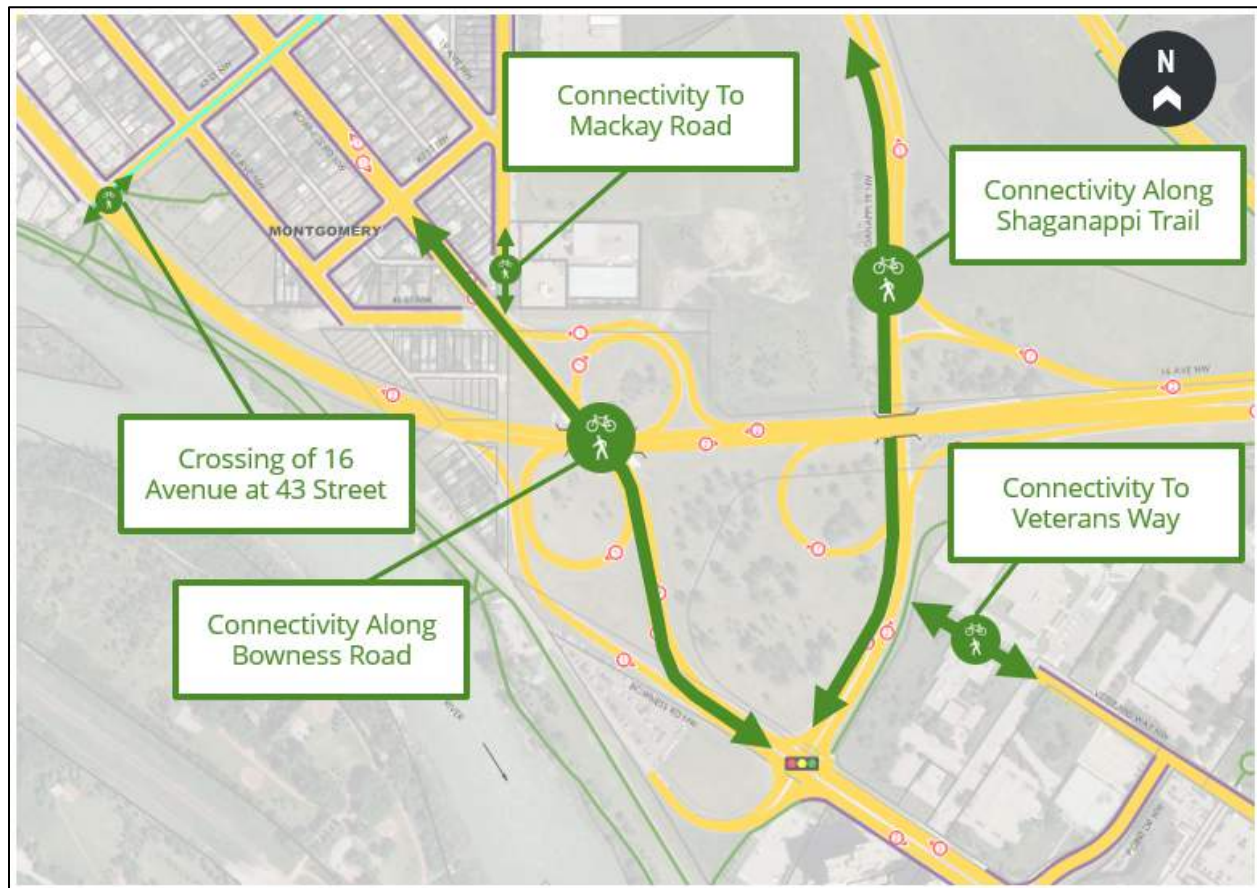

Figure 4.3: Pedestrian & Bicycle Connectivity

Existing pedestrian and bicycle connectivity issues identified were:

- A connection between Bowness Road and MacKay Road does not exist.
- A connection between Veterans Way and Shaganappi Trail does not exist.
- A connection between Edworthy Park and West Campus Way along Shaganappi Trail does not exist.
- A connection between 42 Street and Shaganappi Trail along Bowness Road does not exist.

4.2 IDEAS EVALUATED

Through the November 2016 public engagement, March 2017 Community Advisory Group engagement, and March 2017 Montgomery Community Association engagement, fifteen (15) potential ideas for modification were developed to help address the existing issues and opportunities. Each of these ideas were carefully evaluated to determine how effectively they addressed the existing issues and opportunities that were identified, and what potential adverse consequences they would introduce. They were then categorized as: recommended for short term investment, not recommended, or recommended in conjunction with future study.

SOUTH SHAGANAPPI STUDY

Short Term Investment Plan

A summary of all ideas evaluated is provided in **Table 4-1**, with a detailed summary included in **Appendix G**.

Table 4-1 - Short Term Ideas Evaluated

	Modification	Technical Review Comments	Recommendation
A	<p>Southbound Shaganappi Trail to Eastbound 16 Avenue Ramp Realignment Construct new ramp and acceleration lane. Close existing loop ramp.</p>	<p>This addresses the most significant collision history issue within the study area. There are no major adverse impacts.</p>	<p>Recommended for Short Term Investment</p>
B	<p>Northbound Bowness Road to Westbound 16 Avenue Signalization Introduce new traffic signal to control on ramp movement (from Bowness Road) and Westbound 16 Avenue movement.</p>	<p>This addresses the collision history issue at this location.</p> <p>A dual lane entrance ramp is feasible for this modification, and will improve the operation of this intersection.</p> <p>A two phase signal would control the westbound movement on 16 Avenue and the on ramp movement from Bowness Road. The eastbound movement on 16 Avenue would remain as a free flow condition.</p>	<p>Recommended for Short Term Investment</p>
C	<p>Southbound Shaganappi Trail to Westbound 16 Avenue Signalization Introduce signalized left turn movement (from Southbound Shaganappi Trail ramp) in conjunction with Modification B.</p>	<p>Adverse impacts to operations of all movements at this intersection.</p>	<p>Not Recommended</p>
D	<p>Southbound Bowness Road to Eastbound 16 Avenue Ramp Closure Close existing loop ramp. (To be implemented in conjunction with Modification E).</p>	<p>Based on The City's safety assessment, the benefit to cost ratio of this change is more moderate when considering both the increased collisions that would be anticipated at 43 Street (in the case of Modification E) or the additional cost that would be required for construction (Modification K).</p> <p>With no rerouting of traffic on 43 Street, there are adverse impacts to the operation of Bowness Road and Shaganappi Trail (with and without the implementation of Modification K, Dual Left Turn Lanes).</p> <p>However, it is recommended that The City continues to monitor collision patterns at this location and investigate necessary changes as warranted moving forward.</p>	<p>Not Recommended</p>

SOUTH SHAGANAPPI STUDY

Short Term Investment Plan

Modification		Technical Review Comments	Recommendation
E	<p>43 Street and 16 Avenue Signalization for Rerouted Motor Vehicle Traffic Implement a signalized intersection to accommodate diverted traffic from Southbound Bowness Road to Eastbound 16 Avenue. (Based on the implementation of Modification D).</p>	<p>Based on the community input, the tradeoffs associated with this improvement (as presented) do not appear acceptable for the stakeholders.</p>	Not Recommended
F	<p>Westbound 16 Avenue to Southbound Shaganappi Trail Ramp Closure Close westbound 16 Avenue to southbound Shaganappi Trail stop controlled movement. Introduce a signalized intersection at Bowness Road and westbound 16 Avenue off ramp to accommodate the movement.</p>	<p>This recommendation is not consistent with the long term option, and does not address an existing collision history issue.</p> <p>The modification was initially brought forward by public stakeholders. Their understanding and indication that the tradeoffs do not outweigh the benefits associated with it.</p>	Not Recommended
G	<p>Bowness Road Connectivity Enhancements Implement a new multi-use pathway connection to the existing bikeway on MacKay Road. Implement connectivity enhancements along Bowness Road for people who walk and people who bicycle.</p>	<p>Separated bicycle facilities are not feasible to introduce under the 16 Avenue Bridge on Bowness Road. Therefore, a pathway connection is recommended.</p>	Recommended for Short Term Investment
H	<p>Speed Limit Change on 16 Avenue Reduce the speed limit on 16 Avenue to achieve better consistency in travel speeds along the corridor.</p>	<p>An overall understanding of speed limit implications on 16 Avenue between Sarcee Trail and Crowchild Trail is appropriate for introducing speed limit changes within the study area.</p>	Recommended in Conjunction with Future Study
I	<p>Realignment of Eastbound 16 Ave to Southbound Bowness Road Ramp Realign the existing ramp to increase the weaving distance from the ramp entry point and the intersection of Bowness Road and Shaganappi Trail.</p>	<p>A realignment of this ramp is achievable, and will increase the weaving distance for motor vehicle traffic accessing northbound Shaganappi Trail from eastbound 16 Avenue.</p>	Recommended for Short Term Investment

SOUTH SHAGANAPPI STUDY

Short Term Investment Plan

	Modification	Technical Review Comments	Recommendation
J	<p>43 Street and 16 Avenue Pedestrian/Bike Intersection Options Prepare multiple options to enhance pedestrian and bicycle connectivity along 43 Street and crossing 16 Avenue.</p>	<p>Different options are feasible, and we recommend that multiple options should be reviewed in conjunction with future projects in the area.</p>	<p>Recommended in Conjunction with Future Study</p>
K	<p>Dual Left from Eastbound Bowness Road to Northbound Shaganappi Trail Implement a dual left turn lane to accommodate increased traffic as a result of Modification D (as an alternative to Modification E).</p>	<p>The Dual Left Turn lane was considered as an alternative to Modification E as a means of facilitating the southbound Bowness Road to eastbound 16 Avenue movement.</p> <p>There is a minor operational improvement to introducing the dual Eastbound Left Turn Lane, however, a significant degree of road works at the intersection and along Bowness Road to the east would be necessary to accommodate this change.</p> <p>Due to the magnitude of roadway changes required for this modification, it is not supportable from a benefit to cost perspective for the collision history issue it would support addressing (in conjunction with Modification D).</p>	<p>Not Recommended</p>
L	<p>Closure of south leg of intersection at Bowness Road and Shaganappi Trail with a New Access to Edworthy Park Parking Lot Relocate the existing parking lot access further west to provide for additional green time to the southbound left turn movement at Shaganappi Trail and Bowness Road.</p>	<p>There are minor operational benefits at the intersection for the southbound left movement by removing the south leg of the intersection for people who drive. A new intersection would be required on Bowness Road to provide a different access into the parking lot. In order to realize the operational benefits, the east cross walk at this intersection would need to be closed. This crosswalk is an important connection to the Foothills Medical Centre, and should not be removed. Therefore, the benefits of the improvements do not outweigh the tradeoffs.</p>	<p>Not Recommended</p>

SOUTH SHAGANAPPI STUDY

Short Term Investment Plan

Modification		Technical Review Comments	Recommendation
M	<p>New Signal on 46 Street and 16 Avenue Implement a new traffic signal to control all turn movements at 46 Street and 16 Avenue.</p>	<p>An overall understanding of changes along 16 Avenue and within the Montgomery area would be beneficial for assessing the value of a traffic signal at this location.</p>	<p>Recommended in Conjunction with Future Study</p>
N	<p>Downstream Operational Review on Bowness Road to 37 Street Review and adjust intersection timing along Bowness Road east of Shaganappi Trail to enable more reliable traffic flow through the corridor.</p>	<p>Introducing an eastbound left turn lane at 37 Street and associated signal coordination enhancements as appropriate. This recommendation was advanced and implemented by Roads Traffic during the South Shaganappi Study in 2017.</p>	<p>Complete. Led by Roads Traffic Various Street Improvements Program</p>
O	<p>Left Turn Access for Northbound Bowness Road to Westbound 16 Avenue Movement with a new ramp and signalization on 16 Avenue. Construct a new access from northbound Bowness Road to tie in with the signal as proposed as part of Modification B.</p>	<p>This modification introduces new delay for eastbound traffic on 16 Avenue, and is less efficient than the proposed Modification B</p>	<p>Not Recommended</p>

4.3 RECOMMENDED SHORT TERM INVESTMENTS

Following extensive technical review and evaluation, a short term concept plan was developed incorporating the four ideas recommended for short term investment as summarized below, and shown in **Figure 4.4** and **Figure 4.5**.

- **Construct a new ramp and acceleration lane from southbound Shaganappi Trail to eastbound 16 Avenue.** Constructing a complete acceleration lane addresses the most significant collision history issue within the study area by providing additional length for motor vehicle traffic from southbound Shaganappi Trail to merge onto eastbound 16 Avenue. This investment is anticipated to reduce the number of collisions at this location in the future.
- **Install a new traffic signal and dual lane entrance ramp to control northbound Bowness Road to westbound 16 Avenue.** Installing a new traffic signal at the Bowness Road to 16 Avenue on-ramp will provide signalized separation of traffic movements at this location. The dual lane entrance ramp will provide additional queuing space for vehicles. This investment is anticipated to reduce the number of collisions at this location in the future.
- **Introduce connectivity enhancements along Bowness Road for people who walk and bicycle.** Introducing two new multi-use pathways along Bowness Road between Shaganappi Trail and 42 Street establishes new travel options for people to walk, roll, or bicycle along Bowness Road. Additional pathway connections to Mackay Road and the Harry Boothman Bridge ensures strong integration with the existing active transportation network. This investment is anticipated to support increased walking, rolling, and cycling activity along Bowness Road.
- **Realign the ramp from eastbound 16 Avenue to southbound Bowness Road.** Modifying the existing ramp geometry will result in a longer weaving distance for people who drive to more easily access northbound Shaganappi Trail from eastbound 16 Avenue, while maintaining the existing transit only lane. Realigning the existing ramp allows for extension of the transit only lane creating a bus queue jump for Calgary Transit at the intersection. This investment is anticipated to improve motor vehicle connectivity and traffic operations.

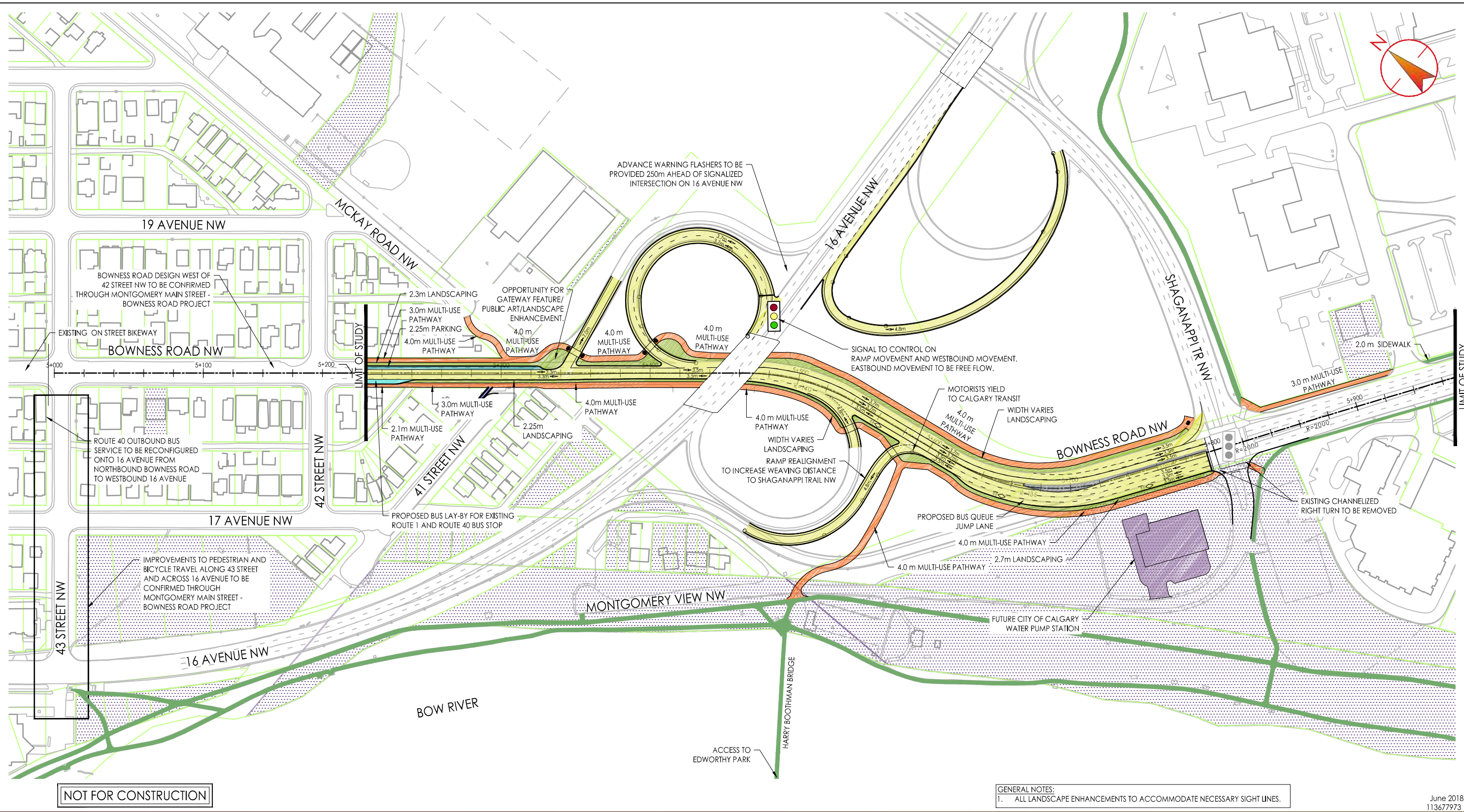

NOT FOR CONSTRUCTION

GENERAL NOTES:
1. ALL LANDSCAPE ENHANCEMENTS TO ACCOMMODATE NECESSARY SIGHT LINES.

June 2018
113677973



200-325 25th Street SE
Calgary AB
www.stantec.com

Legend	
	ULTIMATE ROADWAY
	CITY OWNED PROPERTY OUTSIDE ROAD ROW
	PROPOSED CONCRETE MEDIAN / NOSING
	PROPOSED SIDEWALK
	PROPOSED MULTI-USE PATHWAY
	PROPOSED RESERVED CALGARY TRANSIT BUS LAY-BY
	PROPOSED PARKING LANE
	PROPOSED CURB EXTENSION
	PROPOSED LANDSCAPING
	PROPOSED WATER PUMP STATION
	EXISTING PATHWAY
	EXISTING PROPERTY LINE
	EXISTING BUILDINGS
	PROPOSED TRAFFIC SIGNALS
	EXISTING TRAFFIC SIGNALS

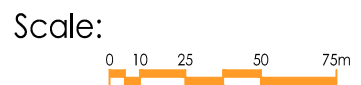

Client/Project
THE CITY OF CALGARY
SOUTH SHAGANAPPI STUDY

Figure No.
4.4

Title
RECOMMENDED SHORT TERM INVESTMENT PLAN

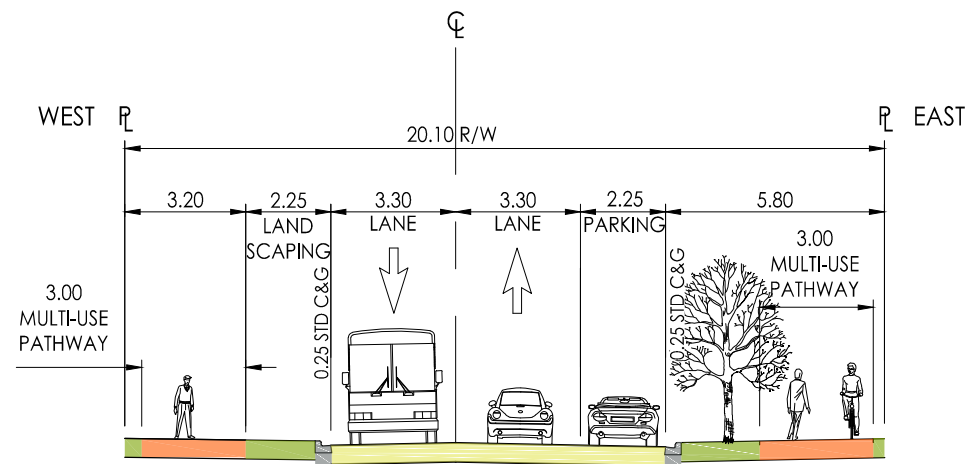

PROPOSED BOWNESS ROAD
NW SOUTH OF 42 STREET NW
2 LANES (50 km/h)

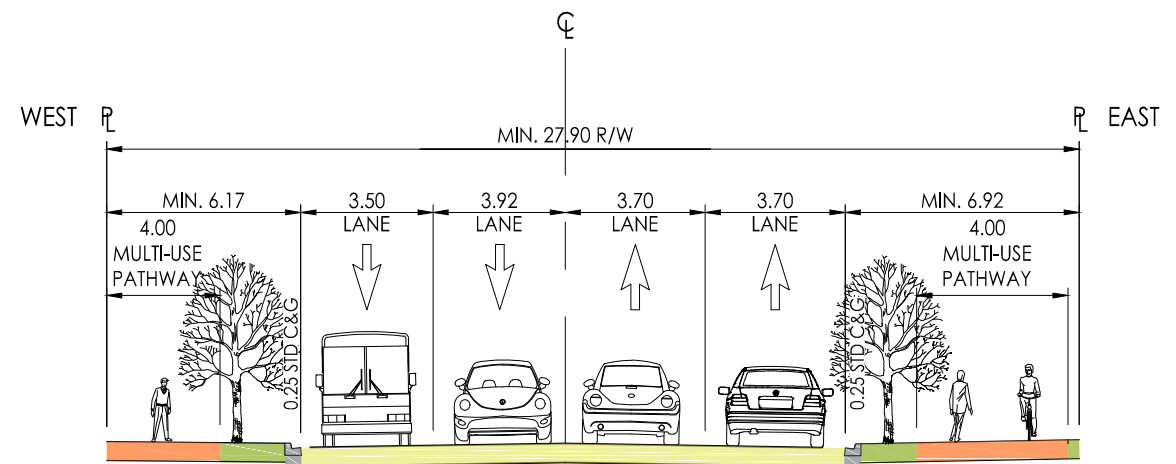

PROPOSED BOWNESS ROAD
NW SOUTH OF 16 AVENUE NW
4 LANES (50 km/h)

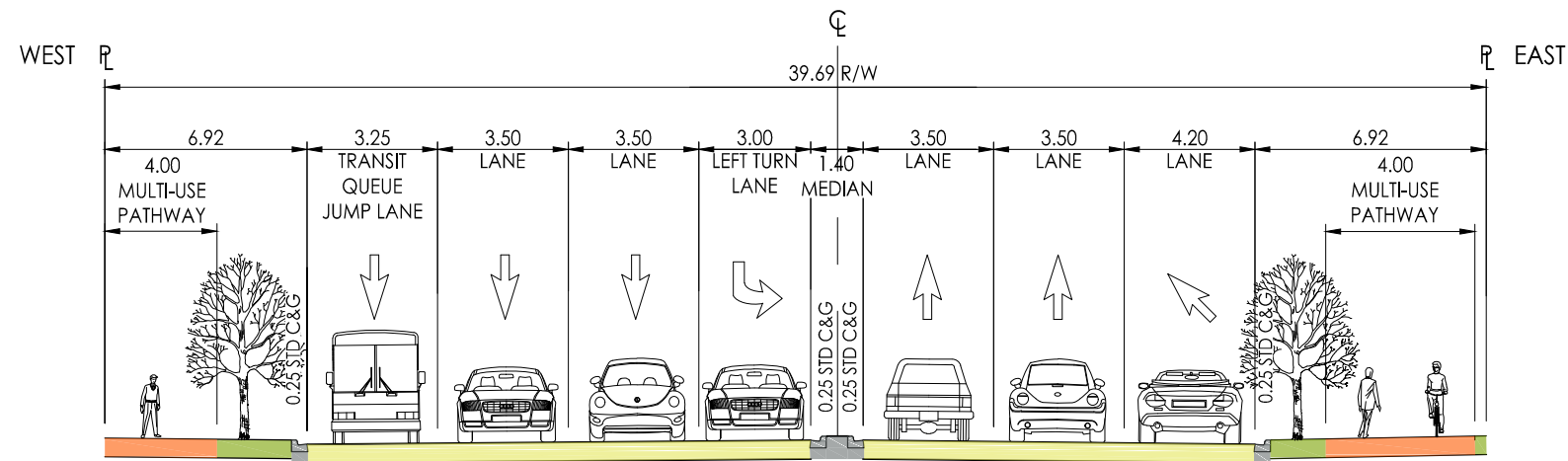

PROPOSED BOWNESS ROAD NW
WEST OF SHAGANAPPI TRAIL NW

NOTES:
1. LANDSCAPING (STREET TREES) SHOWN FOR ILLUSTRATIVE PURPOSES ONLY. LANDSCAPE DESIGN TO OCCUR AT PRELIMINARY DESIGN STAGE.
2. LANE WIDTH AT SHAGANAPPI TRAIL NW (INCLUDING 3.00 m) LEFT TURN LANE MATCH AMBIENT CONDITIONS. MODIFICATION TO INCREASE IS NOT FEASIBLE WITHOUT PROPERTY ACQUISITION.

NOT FOR CONSTRUCTION

JUNE 2018
113677973

\\Cd1002-10A\shared_projects\113677973\07_cad\sheet_files\92_figure\functional_report\113677973_prel_st_tsec_1_package_a.dwg
2018/07/10 4:00 PM By: Wiebe, Brian



200-325 25th Street SE
Calgary AB
www.stantec.com

Legend

- | | | | | | |
|--|--|--|-----------------------------|--|--------------------------|
| | ULTIMATE ROADWAY | | PROPOSED PARKING LANE | | PROPOSED TRAFFIC SIGNALS |
| | CITY OWNED PROPERTY OUTSIDE ROAD ROW | | PROPOSED CURB EXTENSION | | EXISTING TRAFFIC SIGNALS |
| | PROPOSED CONCRETE MEDIAN / NOSING | | PROPOSED LANDSCAPING | | EXISTING TRAFFIC SIGNALS |
| | PROPOSED SIDEWALK | | PROPOSED WATER PUMP STATION | | |
| | PROPOSED MULTI-USE PATHWAY | | EXISTING PATHWAY | | |
| | PROPOSED RESERVED CALGARY TRANSIT BUS LAY-BY | | EXISTING PROPERTY LINE | | |
| | | | EXISTING BUILDINGS | | |

Scale: NTS

THE CITY OF CALGARY
SOUTH SHAGANAPPI STUDY

Figure No.

4.5

Title

SHORT TERM BOWNESS ROAD NW
TYPICAL SECTIONS

4.4 UTILITY ASSESSMENT

This section of the report describes potential conflicts between the proposed road upgrades and the water and sanitary sewer utilities within the study corridor.

4.4.1 Water

The existing 300mm diameter DI watermain pipe that runs along Bowness Road (immediately west of Shaganappi Trail and crossing Bowness Road) may require removal and re-installation with an encasement pipe across Bowness Rd. The 200mm – 150mm diameter CI watermains located under Bowness Road at the west end of the study corridor may also require replacement due to the age and pipe material. It should be confirmed with Water Resources when the watermain is scheduled to be upgraded so that this work can be completed prior to or as a part of the short term investments work. This would avoid potential surface disturbance along Bowness Road should there be maintenance work required shortly after the surface is upgraded.

4.4.2 Sanitary Sewer

The 375mm diameter abandoned sewer and 600mm diameter PVC sanitary sewer which cross Bowness Road between Shaganappi Trail and 16 Avenue are to be reviewed with Water Resources. The oldest of the sanitary mains is the 375mm abandoned concrete main installed in 1970. The 600mm diameter sanitary mains should be in reasonable condition, however further coordination with Water Resources at the time of implementation is needed to find out if condition assessment for these mains is available and if any upgrades projects are planned within the study area.

The condition of the sanitary sewers along Bowness Road at the west end of the study area is anticipated to be acceptable with the exception of the 200mm VCT pipe, which may be approaching its design life and should be considered for replacement. Coordination with Water Resources will be required at the time of implementation to confirm if any upgrades are scheduled for these sanitary sewer lines so that this work can be scheduled prior to or in conjunction with the implementation of short term investments.

SOUTH SHAGANAPPI STUDY

Short Term Investment Plan

4.5 OPINION OF PROBABLE COST

A preliminary order of magnitude opinion of probable cost for each of the Short Term Recommended Investments is summarized in

Table 4-2, Table 4-3, Table 4-4, and Table 4-5. A detailed breakdown is provided in **Appendix H.**

Table 4-2 - Opinion of Probable Cost – Construct a new ramp and acceleration lane from southbound Shaganappi Trail NW to eastbound 16 Avenue NW

Category	Cost*
Roadways	\$240,000.00
Earthworks	\$384,000.00
Removals, Utilities, and Landscaping	\$46,000.00
Sub-Total	\$670,000.00
Contingency (30%)	\$201,000.00
Engineering / Testing (12%)	\$105,000.00
City Administration and Traffic Control (21%)	\$183,000.00
Total	\$1,159,000.00

*Rounded to the nearest \$1,000. Opinion of probable cost based on a Class 5 order of magnitude estimate.

Table 4-3 - Opinion of Probable Cost – Install a new traffic signal and dual lane entrance ramp to control northbound Bowness Road NW to westbound 16 Avenue NW

Category	Cost*
Roadways	\$76,000.00
Traffic Signal	\$250,000.00
Removals, Utilities, and Landscaping	\$46,000.00
Sub-Total	\$372,000.00
Contingency (30%)	\$112,000.00
Engineering / Testing (12%)	\$58,000.00
City Administration and Traffic Control (21%)	\$102,000.00
Total	\$644,000.00

*Rounded to the nearest \$1,000. Opinion of probable cost based on a Class 5 order of magnitude estimate.

SOUTH SHAGANAPPI STUDY

Short Term Investment Plan

Table 4-4 - Opinion of Probable Cost – Introduce connectivity enhancements along Bowness Road NW for people who walk and bicycle

Category	Cost*
Roadways	\$447,000.00
Retaining Walls	\$125,000.00
Removals, Utilities, and Landscaping	\$346,000.00
Sub-Total	\$918,000.00
Contingency (30%)	\$275,000.00
Engineering / Testing (12%)	\$143,000.00
City Administration and Traffic Control (21%)	\$251,000.00
Total	\$1,587,000.00

*Rounded to the nearest \$1,000. Opinion of probable cost based on a Class 5 order of magnitude estimate.

Table 4-5 - Opinion of Probable Cost – Realign the ramp from eastbound 16 Avenue NW to southbound Bowness Road NW

Category	Cost*
Roadways	\$126,000.00
Earthworks	\$48,000.00
Removals, Utilities, and Landscaping	\$46,000.00
Sub-Total	\$220,000.00
Contingency (30%)	\$66,000.00
Engineering / Testing (12%)	\$34,000.00
City Administration and Traffic Control (21%)	\$60,000.00
Total	\$380,000.00

*Rounded to the nearest \$1,000. Opinion of probable cost based on a Class 5 order of magnitude estimate

5.0 LONG TERM CONCEPT DEVELOPMENT AND EVALUATION

A thorough and participatory approach was taken to develop, evaluate, and recommend a preferred long term concept for the South Shaganappi Study Area. This section describes the process taken, the concepts developed, and the evaluation completed to arrive at the preferred long term plan.

5.1 PROCESS TAKEN

This section describes the process that was taken to develop ideas, evaluate concepts, and provide a recommendation.

As described in **Section 2.0**, public and stakeholder participation has been critical throughout the entire study. The concepts developed were the result of a highly collaborative approach between community stakeholders and technical experts. This process allowed for the exploration of a range of ideas and suggestions brought forward to ensure that the optimal configuration was selected.

Clear study goals, project objectives, and evaluation criteria were set forward to transparently evaluate how each of the different concepts performed as a means of selecting the preferred concept. The process taken from project initiation through to preferred concept selection is shown in **Figure 5.1**. The three evaluation steps taken were:

1. **Confirm Project Purpose and Intent.** This step aligned with Phase 1 of the study, and included the definition of study goals, project objectives, evaluation criteria, and design criteria. All of these were developed based on stakeholder input which was solicited through the Community Advisory Group, one Public Open House event, and an online survey.
2. **Develop Design Concepts.** This step aligned with Phase 2A of the study, and was initiated through a public design ideas workshop. The project team worked carefully with adjacent community stakeholders and public stakeholders to develop a range of ideas for how transportation infrastructure could be re-imagined within the study area. This input was synthesized into six design elements which were used as the basis for public engagement, alongside five technical elements identified by the project team. Using the input gathered from the design ideas workshop, the CAG, and online engagement associated with the design and technical elements, a technical workshop was held with thirteen (13) technical experts to develop design concept ideas. A total of eleven (11) concepts were developed through the technical workshop and evaluated using the project accounts and evaluation criteria. The four highest ranked concepts were advanced for feasibility review and evaluation along with the do-nothing concept.
3. **Concept Evaluation.** This step aligned with Phase 2B of the study, and was initiated through a public open house and online survey. The project team collected evaluation scorecards for each of the five concepts to help understand how each concept performed across the different project objectives. This input was then used alongside a technical evaluation which utilized specific metrics for each project objective to measure how each of the five concepts performed. The highest ranking concept from this evaluation was brought forward as the recommended concept.

Figure 5.1: Preferred Concept Selection Process

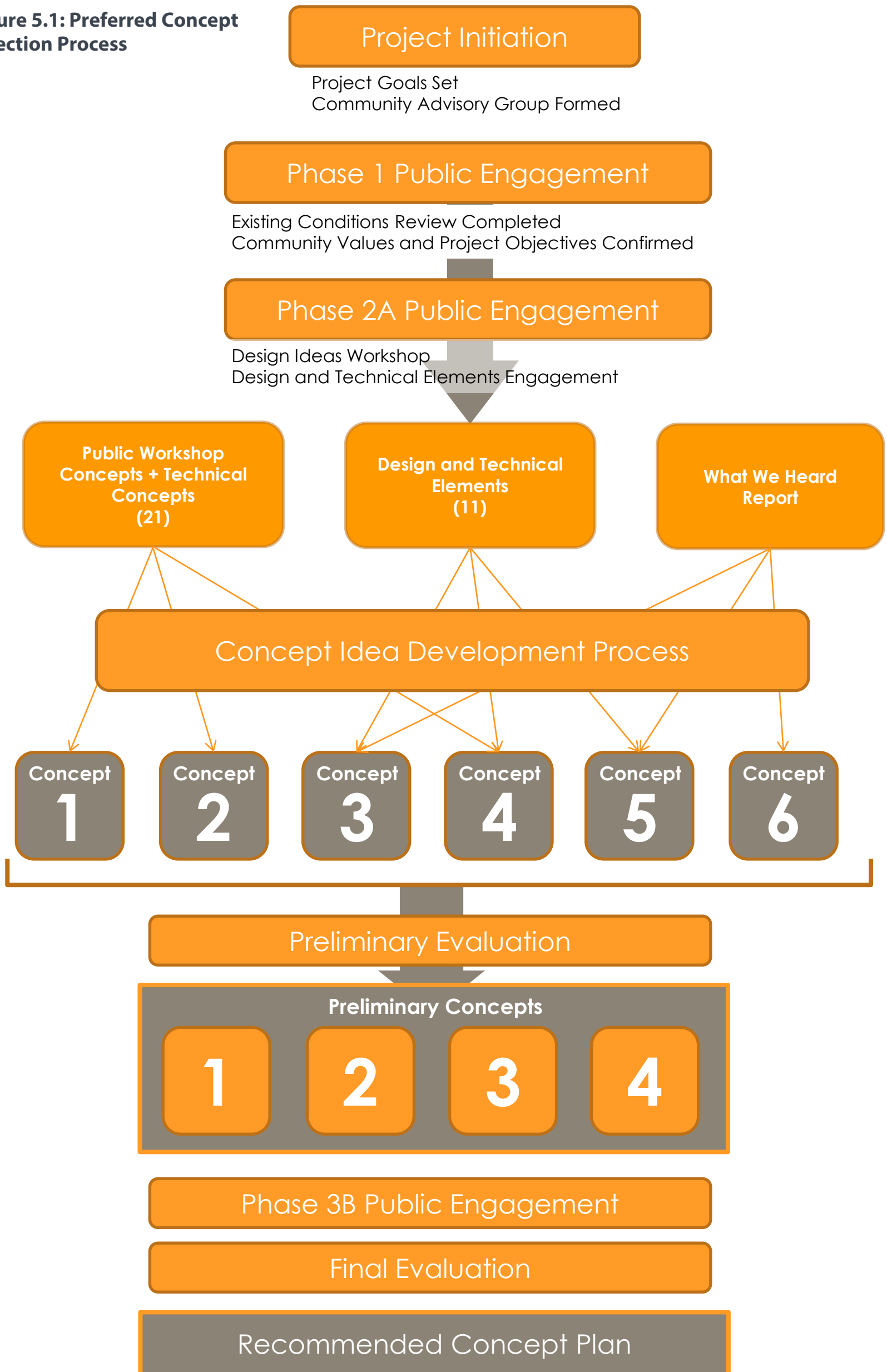

5.2 PROJECT GOALS AND OBJECTIVES

This section summarizes the study goals, project objectives, and design criteria that were collaboratively developed and then utilized to prepare and evaluate concept ideas.

5.2.1 Study Goals

As previously stated in **Section 1.1**, The City developed two goals at the outset of this study:

- 1. Review and recommend infrastructure that aligns the future corridor plans for Shaganappi Trail with the 2009 Calgary Transportation Plan, the Municipal Development Plan, and adjacent land uses.**
- 2. Identify what land will no longer be required for transportation infrastructure.**

5.2.2 Project Objectives

Through stakeholder engagement in Fall of 2015, the following five community values were developed:

1. Address safety for those who use and/or live by the corridor.
2. Address accessibility across and throughout the corridor, reconnecting the adjacent communities of Montgomery and Parkdale/Point McKay.
3. Accommodate all modes of transportation including walking, cycling, driving, HOV, and transit.
4. Move people and goods in an efficient way, providing continuous traffic flow and a reduction in green house gas emissions.
5. Preserve and enhance land within the study area where there are opportunities.

These community values were then incorporated as Project Objectives for the purposes of option evaluation and recommendation. Two additional project objectives were identified and incorporated as follows:

6. Reflect the values and priorities of the community.
7. Develop an affordable and cost-effective solution that produces good value for money.

The seven project objectives are summarized in **Table 5-1**.

Table 5-1 - Project Objectives

Objective	Description
Safety	Improve safety for those who use and/or live by the corridor.
Access and Connectivity	Improve accessibility across and throughout the corridor, reconnecting adjacent communities.
Multi-Modal Transportation	Accommodate all modes of transportation including walking, cycling, HOV, and transit.

SOUTH SHAGANAPPI STUDY

Long Term Concept Development and Evaluation

Objective	Description
Efficient Traffic Flow	Move people and goods in an efficient way, providing continuous traffic flow and a reduction in green house gas emissions.
Land Enhancement	Preserve and enhance land within the study area while minimizing impacts to existing neighbourhoods.
Community Values	Reflect the values and priorities of the community.
Financial Feasibility	Develop an affordable and cost-effective solution that produces good value for money.

5.2.3 Design Criteria

Design criteria provides a method of identifying minimum requirements for transportation infrastructure. The design criteria is based on road classification and associated design guidelines used by The City. This includes the Complete Streets Design Guidelines, the Design Guidelines for Subdivision Servicing (2014), and the Transportation Association of Canada Geometric Design Guidelines (2017).

The design criteria used to develop long term concepts are summarized in **Table 5-2**. It is noted that design criteria were provided for both a Skeletal Road Classification and an Urban Boulevard Road Classification on 16 Avenue. 16 Avenue is classified as an Urban Boulevard west of 43 Street (in Montgomery) and east of Crowchild Trail (in Banff Trail/Briar Hill). Design criteria details were also provided for both an Arterial Road Classification and an Urban Boulevard Road Classification for Shaganappi Trail in the case that a reclassification were to be contemplated. Road classifications were indicated based on the designations for each road as per the Calgary Transportation Plan Maps.

Table 5-2 - Design Criteria
South Shaganappi Study

Design Criteria	16 Avenue NW ¹	Shaganappi Trail		Bowness Road	
		North of 16 Avenue NW	South of 16 Avenue NW	North of 16 Avenue NW	South of 16 Avenue NW
Primary Road Details					
Road Classification	Skeletal <Urban Boulevard>	Arterial	Arterial <Urban Boulevard>	Neighbourhood Boulevard	Parkway
Number of Motor Vehicle Lanes	4, 6 or 8	6	4 or 6	2 or 4	4
Right-Of-Way (m)	60 <36 or 42.6>	46	36 or 46 <36 or 42.6>	30	36
Design Speed (km/h)	80-100 <50>	60	50 or 60	50	50
Daily Traffic Volume (vehicles/day)	> 30,000 <17,500 - 25,000>	20,000 - 35,000	20,000 - 35,000 <17,500 - 25,000>	12,500 - 22,500	20,000 - 35,000
Minimum Intersection Spacing (m)	<120, from Arterial Street; 80, for other streets>	300	<120, from Arterial Street; 80, for all other streets>	120 (from Arterial Street) 60 (with other streets)	300
Base Cross Section					
Inside Lane Width (m)	3.7 <3.3>	3.5	3.5 <3.3>	3.3	3.3
Outside Lane Width (m)	3.7 (3.3)	3.5	3.5 <3.3>	3.3	3.3
Inside Shoulder Width (min.) (m)	2.5 <None>	None	None	None	0.0
Outside Shoulder Width (min.) (m)	2.5 - 3.0 <None>	None	None	None	0.0
Median Width (m)	6 <3.5>	8	6 <3.5>	None	6.0
Pathway Width (m)	None	4	3 (if no bikelanes) <None>	3.0 on both sides (if no bike lane lanes)	3 ³
Sidewalk Width (m)	None <3.0>	None	2 <3.0>	3	2.0
Bike Lane Width (m)	None <2.5>	None	2.5 (if no pathway)	1.5 (if not pathway)	2.5
Curb & Gutter, Size and Type	Outside: 0.25 m Standard C&G Median: 0.25 m Standard C&G	0.25 m Standard C&G	0.25 m standard C&G	0.25 m rolled C&G	0.25m Standard C&G
Base Traffic Features					
Posted Speed (km/h)	80 - 100 <50>	60	50 or 60 <50>	50	50
Street Parking	None <2.1 with 0.8 door zone>	None	None <2.1 with 0.8 door zone>	2.1 with 0.8 door zone with bike lane 2.1 with no bike lane	No
Pedestrian Crossing	Grade Separated <At Grade>	At Grade	At Grade	At Grade	At Grade
CTP Map Classifications³					
Primary Transit Network	No	Yes	Yes	Yes	Yes
Primary HOV Network	Yes	Yes	No	No	Yes
Primary Cycling Network	No	Yes	Yes	No	No
Primary Goods Movement Network	Main Goods Movement	No	No	No	No
Horizontal Geometry					
Minimum Curve Radius (m)	340 <90>	130	90 or 130 m	90	90
Minimum Stopping Sight Distance (m)	140 <65>	85	65 or 85	65	65
Vertical Geometry					
Maximum Grade (%)	4 <8>	6	7 or 6 <8>	8.0	8.0
Minimum Grade (%)	0.8 <0.6>	0.6	0.6	0.6	0.6
Super Elevation (Max.) (%)	6 <4>	6	6 <4>	4.0	4.0
Grade Through Intersection (Max. %)	N/A <4.0>	4.0	4.0	4.0	4.0
Desireable Crest Vertical Curve (K)	TAC <20>	55	35 or 55 <20>	20	20
Minimum Sag Vertical Curve (K) (Comfort Control)	TAC <6>	10	6 or 10	6	10
Access Conditions					
Industrial Properties	Not Permitted	Permitted	Not Permitted	Not Permitted	Generally Not Permitted
Commercial Properties	Not Permitted <Generally Not Permitted>	Permitted	Permitted <Generally Not Permitted>	Generally Not Permitted	Generally Not Permitted
Multi-Residential Properties	Not Permitted <Generally Not Permitted>	Not Permitted	Not Permitted <Generally Not Permitted>	Generally Not Permitted	Generally Not Permitted
Residential Properties	Not Permitted	Not Permitted	Not Permitted	Not Permitted	Not Permitted
Lanes	Not Permitted <Generally Not Permitted>	Not Permitted	Not Permitted <Generally Not Permitted>	Permitted	Not Permitted

NOTES:

¹ Design criteria details are provided for both a Skeletal Road Classification and an Urban Boulevard Road Classification. It should be noted that 16 Avenue NW is classified as an Urban Boulevard west of 43 Street NW (in Montgomery) and east of Crowchild Trail (in Banff Trail/Briar Hill).

Design criteria details are provided for both an Arterial Road Classification and an Urban Boulevard Road Classification.

² A parallel pathway is provided along the Bow River Pathway System.

³ Classification indicated is based on the designations for each road as per the Calgary Transportation Plan Maps.

5.3 CONCEPTS DEVELOPED

5.3.1 Design and Technical Elements

A design ideas workshop was hosted by The City on April 6, 2016 as part of Phase 2: Concept Development and Analysis and was attended by adjacent community members and the general public to create potential design ideas for the study area. Twenty-one different public workshop concepts and technical concepts were developed. Using these concepts, six common design ideas were developed for incorporation into the preliminary concepts. These design elements are described in **Table 5-3**.

Table 5-3 - Design Elements Identified

Design Elements
<ul style="list-style-type: none"> • Change the design of the junction at Shaganappi Trail and 16 Avenue to improve safety and traffic flow for all modes of transportation.
<ul style="list-style-type: none"> • Encourage people who drive to take 16 Avenue by revisiting the way the road functions within the study area.
<ul style="list-style-type: none"> • Improve access and reduce traffic volume and speed on Bowness Road to better accommodate people who walk, bike, and take transit
<ul style="list-style-type: none"> • Explore how land within the study area could be used to improve the area.
<ul style="list-style-type: none"> • Design safe and efficient movement for all modes of transportation through any at-grade intersections that may be developed.
<ul style="list-style-type: none"> • Improve connectivity to and between surrounding communities, key destinations and pathways for people who walk and bike.

In review of the design elements from a technical perspective, five additional elements were noted that should be incorporated into the design process. These are summarized in **Table 5-4**.

Table 5-4 - Technical Elements Identified

Technical Elements
<ul style="list-style-type: none"> • Improve access, amenities, and travel time within the study area for people who take transit and carpool.
<ul style="list-style-type: none"> • Change the role of Shaganappi Trail south of 16 Avenue to support local and community traffic on Bowness Road.
<ul style="list-style-type: none"> • Change how the roads connect to draw the communities of Montgomery, Parkdale, and Point McKay together.
<ul style="list-style-type: none"> • Realign Shaganappi Trail to reduce the footprint of the roadway and free land for other uses.
<ul style="list-style-type: none"> • Provide easy access to all roads in the study area so emergency vehicles can get to their destinations efficiently

Each of the design and technical elements were then shared for feedback from Calgarians as part of a three week online engagement period. This is described in the *South Shaganappi Study 2015 – 2018 Engagement Summary Report*.

SOUTH SHAGANAPPI STUDY

Long Term Concept Development and Evaluation

5.3.2 Technical Working Session

Using public input gathered, a Technical Working Session between the consulting team and The City including participation from Network Planning, Roads, Calgary Transit, and Land Use Planning led to the development of unique design ideas that were assessed using the approved project evaluation criteria. Four concepts, in addition to a do nothing concept, were reviewed in further detail with consideration for road geometry, traffic operations, transit operations, pedestrian and bicycle connectivity, and future land repurposing flexibility.

The long term concepts developed for evaluation are shown on **Figure 5.2** through **Figure 5.6**. A brief description of each of the concepts is provided in the following sections.

5.3.3 Concepts Developed

5.3.3.1 At-Grade Intersections

This concept, as shown in **Figure 5.2**, consists of new at-grade intersections on 16 Avenue at Bowness Road and Shaganappi Trail. All existing interchange ramps located at these junctions would be removed.

Based on the preliminary traffic operations assessment, it was concluded that the traffic performance of the at-grade intersections would be poor. It is unlikely that additional traffic volumes from future area development could be accommodated without further compromising the operation of the intersections.

To provide improved bicycle connectivity on Bowness Road north of the study area, it was recommended that bicycle accommodation be provided north of Shaganappi Trail to connect with future improvements on Bowness Road north of 41 Street. A protected bicycle facility is recommended due to the anticipated volume and speed of traffic on Bowness Road at this location. Multi-use pathways are proposed on both sides of Shaganappi Trail to tie in with the approved facility as noted in the Shaganappi Trail North Corridor Study, however, further design assessment would be needed to ensure a clear, safe, and comfortable crossing of 16 Avenue.

There would be no substantial change to the proposed bus routing. However, travel time for Routes 1, 305, and 40 would increase as a result of the new at-grade intersection at Bowness Road and 16 Avenue.

5.3.3.2 East-West Couplet

This concept, as shown in **Figure 5.3**, consists of a reconfiguration of 16 Avenue into an east-west couplet with at-grade intersections at Bowness Road and Shaganappi Trail. Similar to the At-Grade Intersections Concept, this concept will include closure of all existing interchange ramps, and the existing 16 Avenue roadway. This concept will require land acquisition south of 16 Avenue to accommodate the realigned southern leg of the couplet. This is consistent with the Montgomery Area Redevelopment Plan Transportation Policy, however, is an additional cost and impact associated with this concept. It should further be noted that a north alignment was investigated, however, it resulted in greater property impacts.

It is expected that this concept would provide for acceptable traffic performance; although with future area development, signalized intersections would be approaching capacity at the forecast horizon.

SOUTH SHAGANAPPI STUDY

Long Term Concept Development and Evaluation

Bicycle accommodation is proposed similar to the At-Grade Intersection Concept. It is noted that with future changes to the remnant lands within the study area, enhanced pedestrian and bicycle connectivity through future development should be accommodated for all options. This may include a new connection to Veterans Way, complete with a pedestrian/bicycle crossing at this location.

There would be no substantial change to the proposed bus routing. However, travel time for Routes 1, 305, and 40 would increase as a result of the new at-grade intersections on 16 Avenue at Bowness Road and Shaganappi Trail.

5.3.3.3 Hybrid

This concept, as shown on **Figure 5.4**, realigns both Shaganappi Trail and Bowness Road, complete with new grade separated structures on 16 Avenue at Shaganappi Trail and Bowness Road. The realignment of Shaganappi Trail is necessary to achieve a maximum grade of 6.0% outside of the signalized intersection and 4.0% through the intersection. It was also necessary to mitigate significant cut slope requirements with the alignment of the new road connection between 16 Avenue and Shaganappi Trail. All existing interchange ramps would be closed, and a new two-way road connection would be constructed between 16 Avenue and Shaganappi Trail to provide all of the turning movements between Shaganappi Trail and 16 Avenue.

It is expected that this concept will provide for acceptable traffic performance; although with future area development, signalized intersections at the new road connection will be approaching capacity at the forecast horizon. There is the potential for inclusion of an eastbound to southbound ramp from 16 Avenue to Bowness Road to accommodate additional traffic capacity. This ramp may be desirable for all traffic or transit/HOV only, however this ramp could limit flexibility for repurposed land.

Bicycle accommodation is proposed similar to the At-Grade Intersections Concept. However, if the access ramp is desired from 16 Avenue to Bowness Road, a two-way bicycle facility on the east side of the ramp may be preferred.

This concept will result in impacts to Route 40 in the inbound direction only. Buses would be required to utilize the new access road between 16 Avenue and Shaganappi Trail or access Bowness Road via 43 Street.

5.3.3.4 Tight Urban Diamond

This concept, as shown on **Figure 5.5**, consists of a new Tight Urban Diamond Interchange providing all turn movements at the Shaganappi Trail and 16 Avenue intersection. The junction of 16 Avenue and Bowness Road would be grade separated but no turning movements would be provided. A new structure would be required to provide three travel lanes in each direction on 16 Avenue. All existing ramps would be removed. Similar to the Hybrid concept, there is potential for inclusion of an eastbound to southbound ramp from 16 Avenue to Bowness Road to accommodate additional traffic capacity for either all traffic or transit/HOV only. A diverging diamond interchange configuration was also assessed. However, this option was not selected due to the increased land requirements and reduced flexibility for repurposing adjacent parcels in the future.

It is expected that this concept would provide for acceptable traffic performance; although with future land repurposing, signalized intersections would be approaching capacity at the forecast horizon.

SOUTH SHAGANAPPI STUDY

Long Term Concept Development and Evaluation

Bicycle accommodation is proposed similar to the At Grade Intersections concept. However, if the access ramp is desired from 16 Avenue to Bowness Road, a two-way bicycle facility type on the east side of the ramp may be preferred.

This concept would result in impacts to Route 40 in the inbound direction only. Buses would be required to utilize the tight diamond interchange and turn right onto Shaganappi Trail, or access Bowness Road via 43 Street.

5.3.4 No Build











This concept, as shown on **Figure 5.6**, retains all infrastructure within the study area as it currently exists. Although cost savings as part of this concept are considered significant, existing bridge infrastructure within the Study Area will require major rehabilitation beyond a 35-year service life, thus impacting the financial feasibility of this concept.



U:\113677973\07_cad\sheet_files\91_sketch\sk_005_at_grade.dwg
 2018/06/12 2:56 PM By: Wiebe, Brian

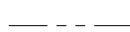

LEGEND

- | | | | | | |
|---|------------------------|---|------------------|---|------------------------------|
|  | ROADWAYS |  | ROAD CLOSED |  | PROPOSED PROTECTED BIKE LANE |
|  | PROPOSED PATHWAY |  | EXISTING PATHWAY |  | EXISTING SIGNAL |
|  | PROPOSED PROPERTY LINE |  | NUMBER OF LANES |  | PROPOSED SIGNAL |
|  | EXISTING PROPERTY LINE | | | | |

Client/Project
 THE CITY OF CALGARY
 SOUTH SHAGANAPPI STUDY

Figure No.
 5.2

Title
 LONG TERM CONCEPT
 AT GRADE INTERSECTIONS

0 100m
 June 2018
 113677973



- NOTES:
1. ADDITIONAL TURN LANES WILL BE REQUIRED AT INTERSECTIONS WITHIN THE STUDY AREA.
 2. FUTURE BICYCLE ACCOMMODATIONS ANTICIPATED ON BOWNESS ROAD NW NORTH OF 41 AVENUE NW.
 3. ALL LAND USES TO BE CONFIRMED THROUGH FUTURE LAND USE STUDY.
 4. PROPERTY LINES SHOWN ARE APPROXIMATE, AND SUBJECT TO CHANGE BASED ON GRADING.

U:\113677973\07_cad\sheet_files\91_sketch\sk_006_e_w_couplet_plan.dwg
 2018/06/12 3:07 PM By: Wiebe, Brian

LEGEND

	ROADWAYS		ROAD CLOSED		PROPOSED PROTECTED BIKE LANE
	PROPOSED PATHWAY		EXISTING PATHWAY		EXISTING SIGNAL
	PROPOSED PROPERTY LINE		NUMBER OF LANES		PROPOSED SIGNAL
	EXISTING PROPERTY LINE				



Client/Project
 THE CITY OF CALGARY
 SOUTH SHAGANAPPI STUDY

Figure No.
 5.3

Title
 LONG TERM CONCEPT
 EAST WEST COUPLET

June 2018
 113677973



- NOTES:
1. ADDITIONAL TURN LANES WILL BE REQUIRED AT INTERSECTIONS WITHIN THE STUDY AREA.
 2. FUTURE BICYCLE ACCOMMODATIONS ANTICIPATED ON BOWNESS ROAD NW NORTH OF 41 AVENUE NW.
 3. ALL LAND USES TO BE CONFIRMED THROUGH FUTURE LAND USE STUDY.
 4. PROPERTY LINES SHOWN ARE APPROXIMATE, AND SUBJECT TO CHANGE BASED ON GRADING.

U:\113677973\07_cad\sheet_files\91_sketch\sk_007_hybrid_option_a.dwg
2018/06/14 11:01 AM By: Wiebe, Brian

LEGEND

	ROADWAYS		ROAD CLOSED		PROPOSED PROTECTED BIKE LANE
	PROPOSED PATHWAY		EXISTING PATHWAY		EXISTING SIGNAL
	PROPOSED PROPERTY LINE		NUMBER OF LANES		PROPOSED SIGNAL
	EXISTING PROPERTY LINE				



Client/Project
THE CITY OF CALGARY
SOUTH SHAGANAPPI STUDY

Figure No.
5.4

Title
LONG TERM CONCEPT
HYBRID



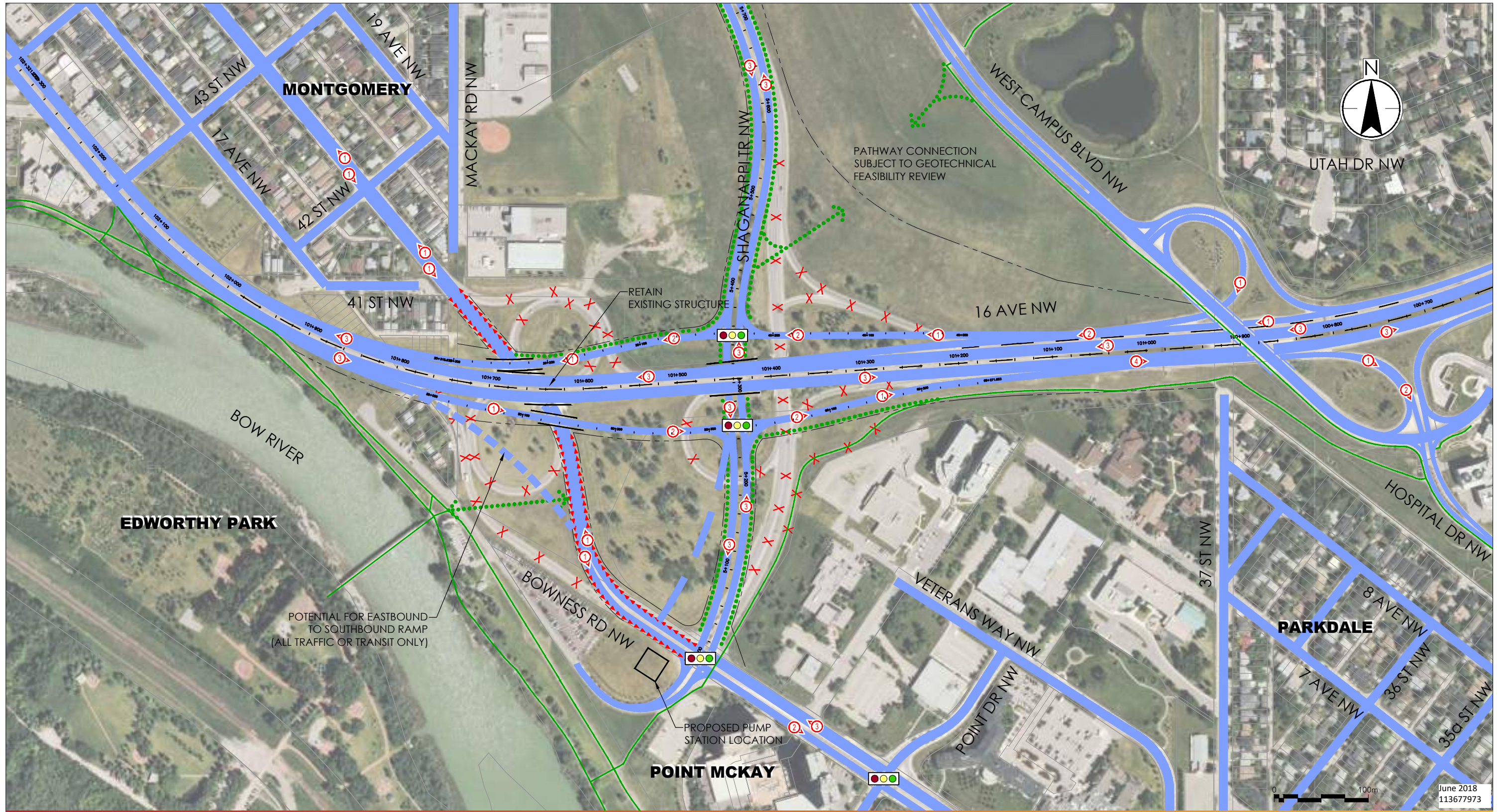







June 2018
113677973



U:\113677973\07_cad\sheet_files\91_sketch\sk_008_tight_urban_diamond.dwg
 2018/06/14 10:59 AM By: Wiebe, Brian

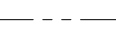

LEGEND

- | | | | | | |
|---|------------------------|---|------------------|---|------------------------------|
|  | ROADWAYS |  | ROAD CLOSED |  | PROPOSED PROTECTED BIKE LANE |
|  | PROPOSED PATHWAY |  | EXISTING PATHWAY |  | EXISTING SIGNAL |
|  | PROPOSED PROPERTY LINE |  | NUMBER OF LANES |  | PROPOSED SIGNAL |
|  | EXISTING PROPERTY LINE | | | | |

Client/Project
 THE CITY OF CALGARY
 SOUTH SHAGANAPPI STUDY

Figure No.
 5.5

Title
 LONG TERM CONCEPT
 TIGHT URBAN DIAMOND

June 2018
 113677973



NOT FOR CONSTRUCTION

1:4000 0 10 25 50 75 100m

JUNE 2018
113677973

Client/Project
THE CITY OF CALGARY
SOUTH SHAGANAPPI STUDY







Figure No.
5.6

Title
DO NOTHING CONCEPT



200 - 325 25th Street SE
Calgary, AB T2A 7H8
www.stantec.com

Legend

-  ROADWAYS
-  EXISTING SIGNAL
-  EXISTING PROPERTY LINE
-  EXISTING SIDEWALK
-  EXISTING BICYCLE ROUTE
-  EXISTING PATHWAY
-  NUMBER OF LANES

5.4 CONCEPT EVALUATION

Each of the preliminary concepts were evaluated using the seven project objectives described in **Section 5.2.2**. Evaluation criteria were developed for each of the project objectives and then used to assess how each concept performed.

- **Develop evaluation criteria.** Evaluation criteria were developed to measure how each concept performs within each project objective. Multiple evaluation criteria were developed where necessary to measure different characteristics of each project objective.
- **Assess concept performance.** Each concept was assessed across each of the evaluation criteria, resulting in a score between one (1) and five (5) for each. A score of five (5) means that the concept performs well within the criteria. A score of one (1) means that the concept performs poorly within the criteria.
- **Summarize total score.** The total score for each project objective was calculated to determine the highest performing concept. The concept with the highest performance across all of the project objectives is then identified. It should be noted that all evaluation criteria and project accounts carry equal weight to minimize subjective value judgement in the evaluation process

The following sections outline the evaluation criteria used, the results of the concept evaluation, and the final recommended concept.

5.4.1 Evaluation Criteria

Appropriate technical evaluation criteria were developed for each of the seven objectives, and used to quantify how well the concepts met the project objectives. The evaluation criteria for each of the objectives is summarized in **Table 5-5**.

Table 5-5 - Evaluation Criteria Summary

Project Objective	Description	Evaluation Criteria
Safety	Improve safety for those who use and/or live by the corridor.	<ul style="list-style-type: none"> • The proposed concept reduces the number or severity of potential conflict points between vehicles. • The proposed concept reduces exposure for pedestrian and bicycles.
Access and Connectivity	Improve accessibility across and throughout the corridor, reconnecting adjacent communities.	<ul style="list-style-type: none"> • Access to communities, institutions, and adjacent businesses to the study area are maintained or enhanced. • Satisfactory access is available into remnant land parcels from the surrounding neighbourhoods.
Multi-Modal Transportation	Accommodate all modes of transportation including walking, cycling, HOV (high occupancy vehicles), and transit.	<ul style="list-style-type: none"> • Enhanced access to key destinations is provided through the study area with increased permeability across the major roadways. • A network of high quality connected bicycle routes is provided within the study area to minimize additional travel time for bicycle users.

SOUTH SHAGANAPPI STUDY

Long Term Concept Development and Evaluation

Project Objective	Description	Evaluation Criteria
		<ul style="list-style-type: none"> Infrastructure supports direct and efficient transit operation for both current and planned routes through the study area. Infrastructure supports direct and efficient HOV facility operation in alignment with the CTP.
Efficient Traffic Flow	Move people and goods in an efficient way, providing continuous traffic flow and a reduction in GHG emissions.	<ul style="list-style-type: none"> The proposed concept optimizes reliable travel time for motor vehicles on 16 Avenue, Shaganappi Trail, and Bowness Road (south of Shaganappi Trail). The proposed concept optimizes turn movements for motor vehicles between Shaganappi Trail and 16 Avenue.
Land Enhancement	Preserve and enhance land within the study area while minimizing impacts to existing neighbourhoods.	<ul style="list-style-type: none"> Remnant land parcel sizes are suitable to accommodate a range of future potential uses. Remnant land parcel sizes have flexibility for access and servicing. Remnant land parcel locations are optimized to provide integration with the Bow River and distance from transportation infrastructure.
Community Values	Reflect the values and priorities of the community.	<ul style="list-style-type: none"> The preliminary concepts meets the community values, community preferences, and project objectives
Financial Feasibility	Develop an affordable and cost-effective. Costs should be achievable, sustainable in the long term and provide good value for money.	<ul style="list-style-type: none"> The estimated capital cost to build the proposed infrastructure is minimized

SOUTH SHAGANAPPI STUDY

Long Term Concept Development and Evaluation

5.4.2 Concept Evaluation

The results of the evaluation for each of the project objectives is described below.

5.4.2.1 Safety

The **Tight Urban Diamond Concept** ranks the highest because this configuration has the least number of intersection conflict points and the fewest number of lane crossings for people who walk and bicycle. The At-Grade Intersections Concept ranks poorly due to the high number of intersection conflict points and the large number of lane crossings for people who walk and bicycle. The Do Nothing Concept also ranks poorly due to the demonstrated existing collision issues and lack of bicycle/pedestrian connectivity through the study area.

The Safety Evaluation Summary is shown on **Figure 5.7**.

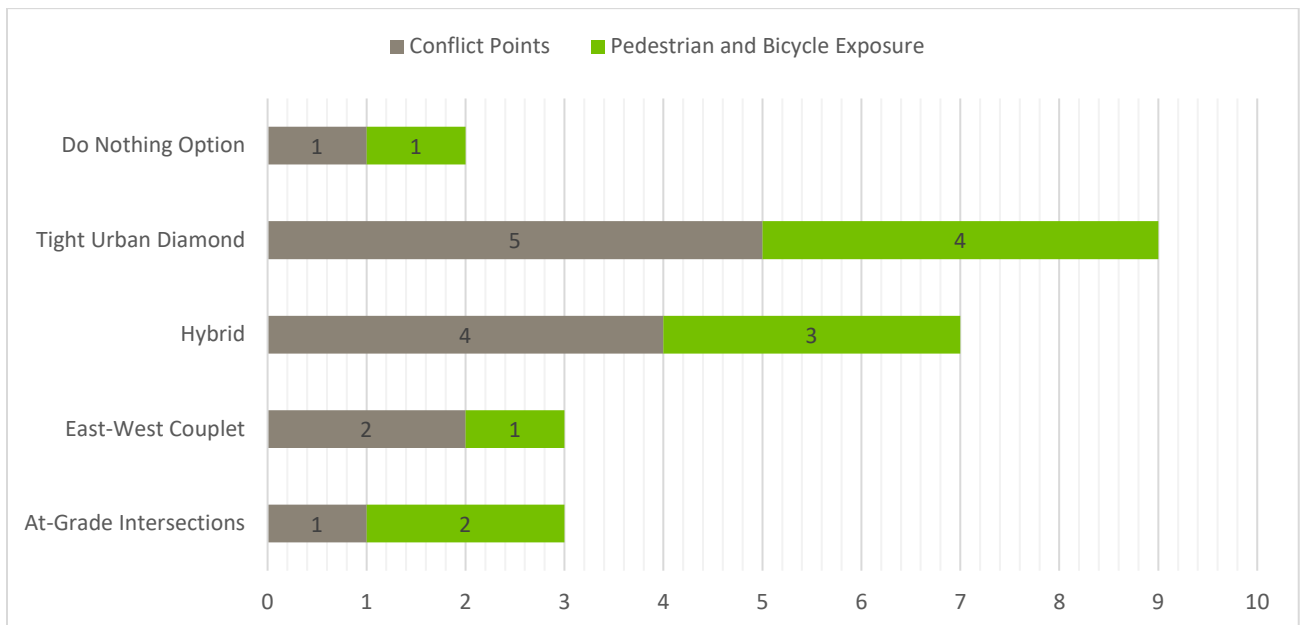

Figure 5.7: Safety Evaluation Summary

SOUTH SHAGANAPPI STUDY

Long Term Concept Development and Evaluation

5.4.2.2 Access and Connectivity

The **At Grade Intersections Concept** ranks the highest due to the integration opportunity for access to the remnant parcels from the existing communities, combined with enhanced access between communities adjacent to the study area.

The Access and Connectivity Evaluation Summary is shown on **Figure 5.8**.

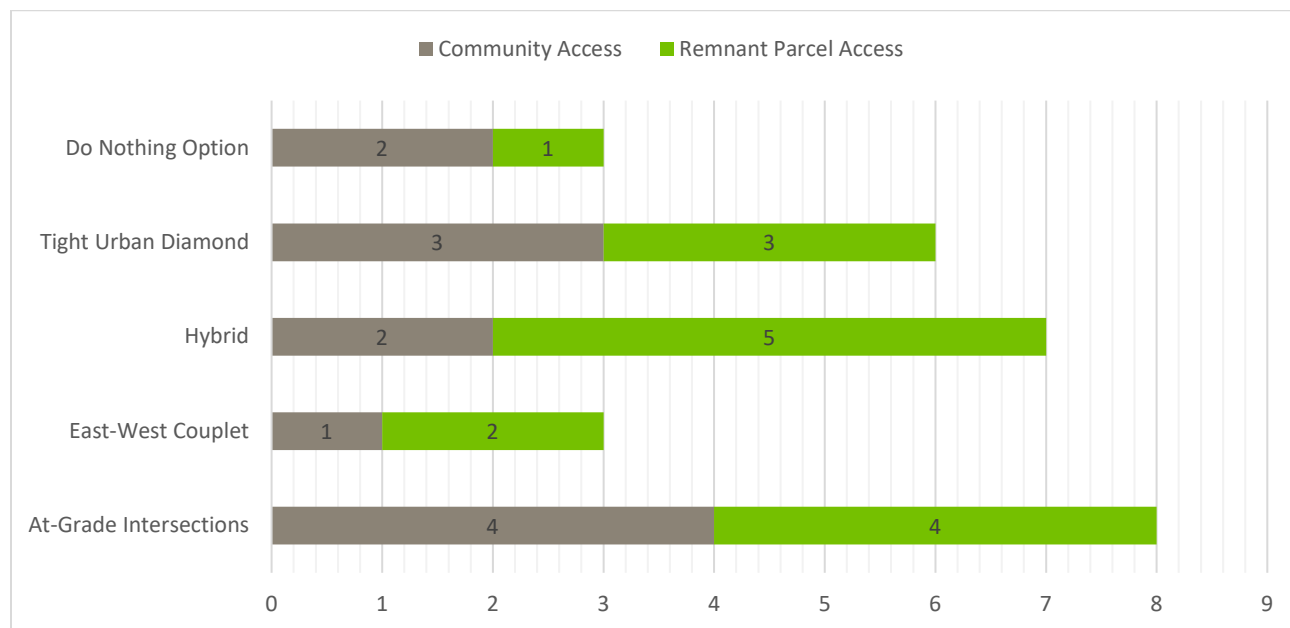

Figure 5.8: Access and Connectivity Evaluation Summary

SOUTH SHAGANAPPI STUDY

Long Term Concept Development and Evaluation

5.4.2.3 Multi-Modal Transportation

The **At-Grade Intersections Concept** ranks highest in this account due to the density of network connections for people who walk and bicycle, along with the flexibility for future transit connections in this area. The Do Nothing Concept ranks lowest due to the lack of infrastructure in place for people who walk and bicycle on Bowness Road, Shaganappi Trail, and 16 Avenue.

The Multi-Modal Transportation Evaluation Summary is shown on **Figure 5.9**.

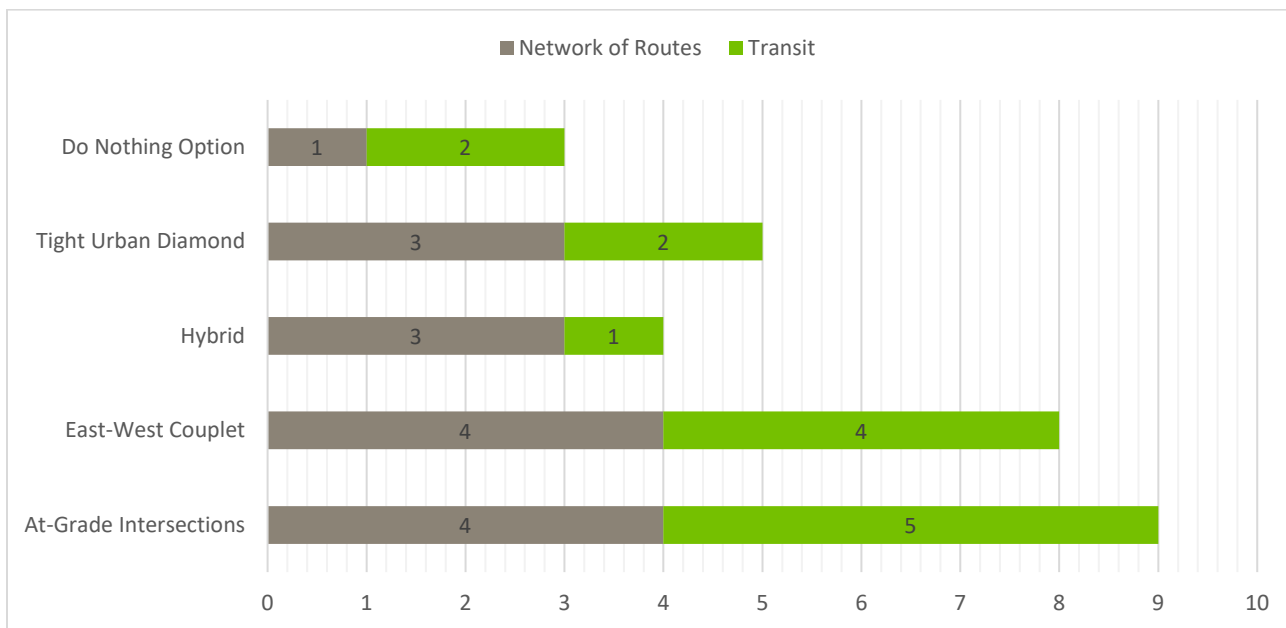

Figure 5.9: Multi-Modal Transportation Evaluation Summary

SOUTH SHAGANAPPI STUDY

Long Term Concept Development and Evaluation

5.4.2.4 Efficient Traffic Flow

The **Tight Urban Diamond Concept** ranks highest due to the level of grade separation and efficient intersection configurations which is maintained for the forecasted motor vehicle traffic in this area.

The Efficient Traffic Flow Evaluation Summary is shown on **Figure 5.10**.

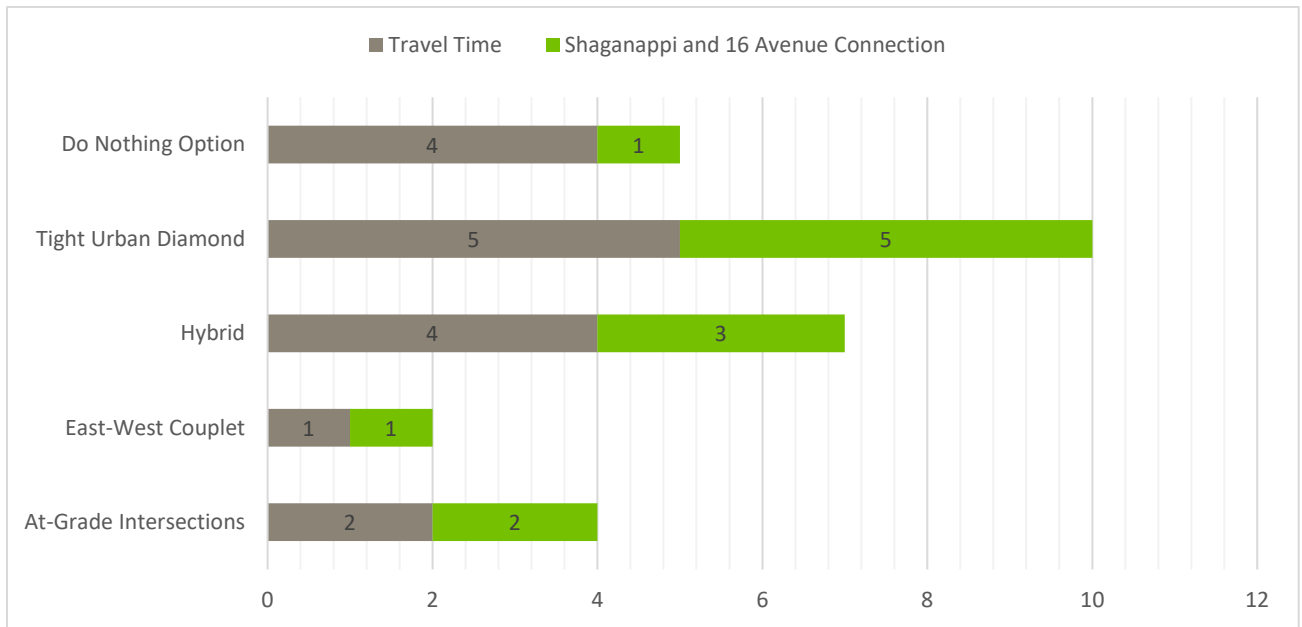

Figure 5.10: Efficient Traffic Flow Evaluation Summary

SOUTH SHAGANAPPI STUDY

Long Term Concept Development and Evaluation

5.4.2.5 Land Enhancement

The **Tight Urban Diamond Concept** and **Hybrid Concept** are ranked highest due to the flexibility they afford for realignment of Bowness Road to expand parcel depth adjacent to the river.

The Land Enhancement Evaluation Summary is shown on **Figure 5.11**.

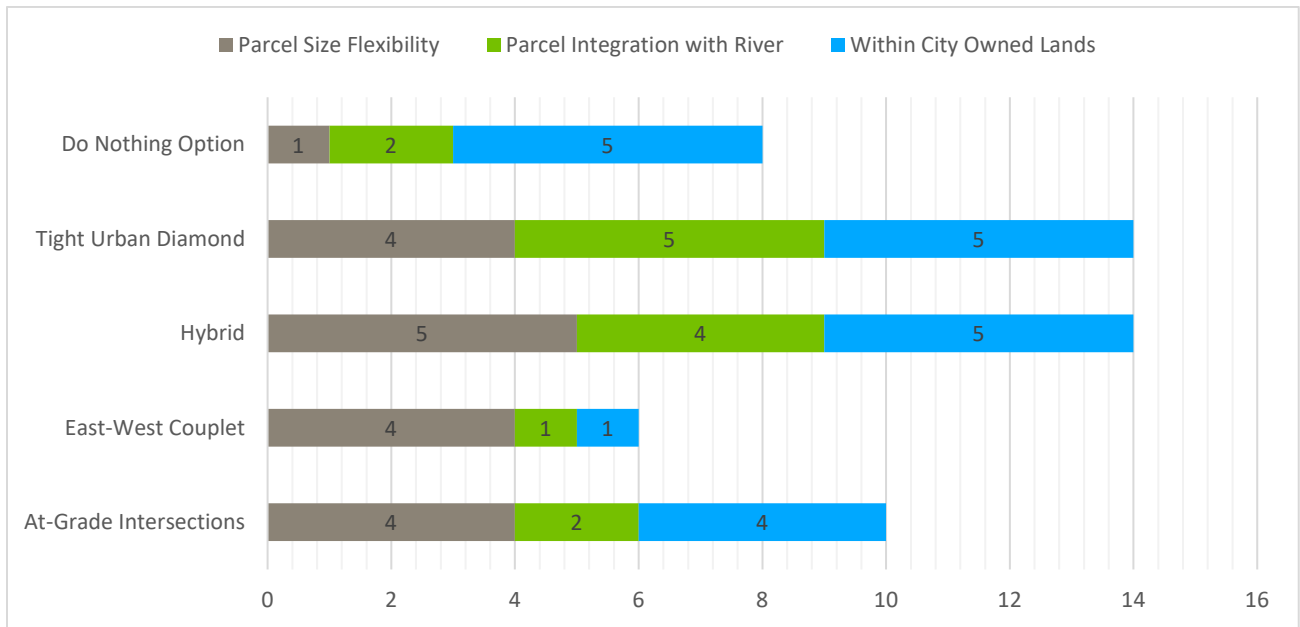

Figure 5.11: Land Enhancement Evaluation Summary

SOUTH SHAGANAPPI STUDY

Long Term Concept Development and Evaluation

5.4.2.6 Stakeholder Input

The **Tight Urban Diamond** was ranked highest based on stakeholder input, with the Hybrid Concept ranked lowest.

The Stakeholder Input Evaluation Summary is shown on **Figure 5.12**.

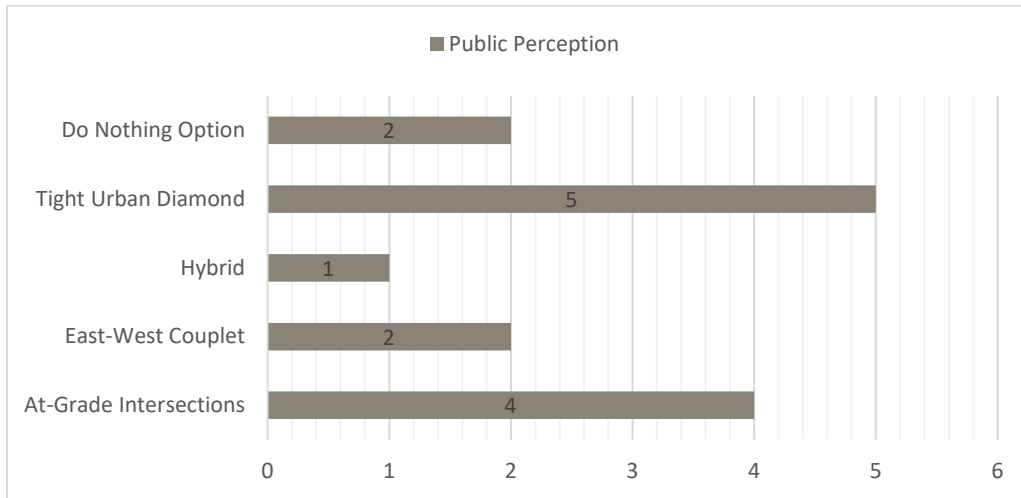

Figure 5.12: Stakeholder Input Evaluation Summary

SOUTH SHAGANAPPI STUDY

Long Term Concept Development and Evaluation

5.4.2.7 Financial Feasibility

The **Do Nothing Concept** was ranked highest as no new infrastructure would be required, but major rehabilitation would be required beyond the 35-year bridge structure service life.

The Financial Feasibility Evaluation Summary is shown in **Figure 5.13**.

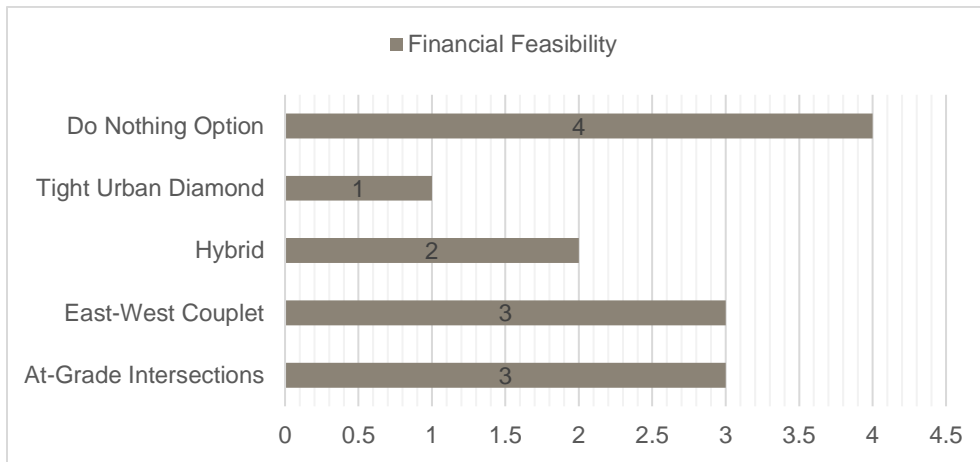

Figure 5.13: Financial Feasibility Evaluation Summary

SOUTH SHAGANAPPI STUDY

Long Term Concept Development and Evaluation

5.4.3 Summary of Results

The highest performing concept for each objective based on the evaluation is summarized in **Figure 5.14** and shown in detail in **Appendix I**.

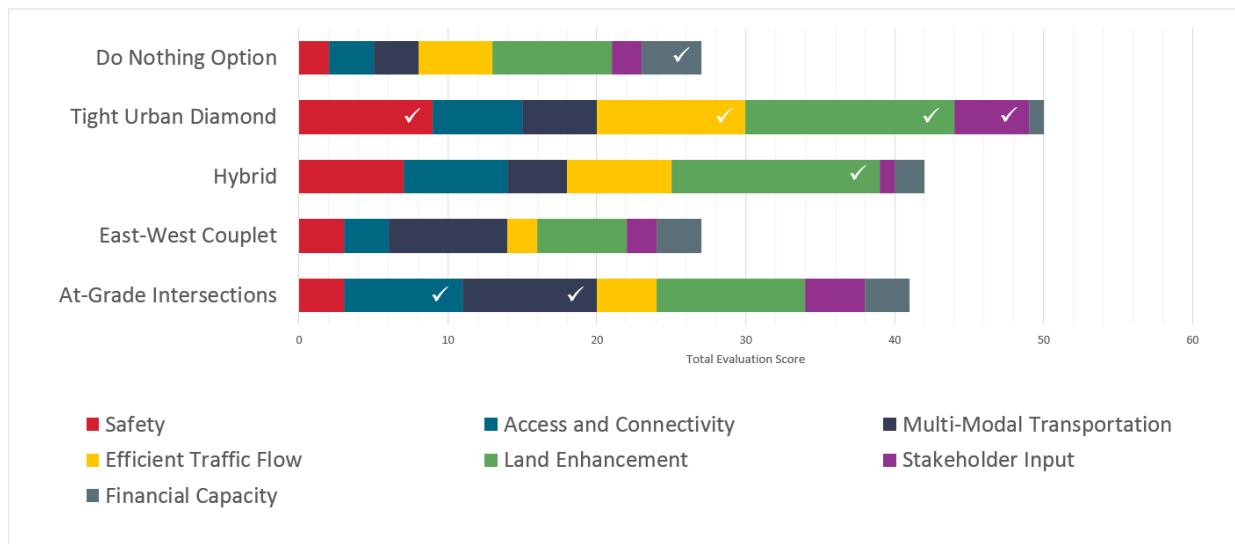

Figure 5.14: Summary of Evaluation

As shown, the Tight Urban Diamond performs the strongest across the six project objectives. It performed the highest across the most number of objectives, and as a total of the evaluation scores across all objectives. Based on this evaluation, the Tight Urban Diamond is recommended as the preferred concept. This concept is anticipated to provide The City the best value for transportation infrastructure investment in the long term within the project area.

6.0 RECOMMENDED CONCEPT

The Tight Urban Diamond Concept is the recommended long term concept for the South Shaganappi Study. This concept was presented to community stakeholders and Calgarians in June 2017 for feedback, comments, and ideas for improvement. The project team incorporated many of these ideas, undertook a detailed traffic analysis, and finalized the concept with internal City stakeholders before presenting back to Calgarians in March 2018.

The final recommended concept is described within this section. A focus is provided on how the recommended concept aligns with the study goals and project objectives described within **Section 1.1**.

6.1 ULTIMATE ROADWAY CONCEPT

The final recommended concept is shown in **Figure 6.1** through **Figure 6.6**. Land no longer required for transportation infrastructure is shown in **Figure 6.7**. Plan and profile figures for each of the roadways are also provided for in **Appendix J**.

6.1.1 Overview

The primary aspects of the recommended plan are summarized as follows:

Accommodates all turns between 16 Avenue and Shaganappi Trail at one intersection unlike the existing infrastructure with loop ramps. All movements between 16 Avenue and Shaganappi Trail will be consolidated to a single interchange location. This consolidation enables a more efficient use of land within the study area, and enables flexibility for access and connectivity along Bowness Road.

Enhance bicycle and pedestrian mobility in the area. Significant connectivity enhancements for people who walk, roll, and bicycle are recommended along Bowness Road, 16 Avenue, and Shaganappi Trail. This includes recommendations for new multi-use pathways, new on street bicycle facilities, new sidewalks, and new pathway bridges. All together, these modifications will provide an enhanced level of connectivity and improve access between communities for people who walk, roll, and bicycle.

Maximizes land that is no longer required for transportation. Land no longer required for transportation infrastructure has been identified, with the placement of proposed roads in such a manner as to maximize the flexibility with which the remnant land can be repurposed.

Encourages through traffic to stay on 16 Avenue discouraging neighbourhood cut-through traffic. The recommend plan intentionally seeks to maintain motor vehicle traffic on 16 Avenue, and discourage the use of the Bowness Road, 3 Avenue, and Parkdale Boulevard to access the downtown core. This is supported by the classification of 16 Avenue as a skeletal road through the study area, and by the transportation network enhancements planned for Crowchild Trail between 17 Avenue SW and 24 Avenue NW.

Enables multimodal mobility along Shaganappi Trail. Since it is classified as an Arterial Road within the Calgary Transportation Plan, it is important to ensure that Shaganappi Trail maintains an acceptable level of mobility for people who drive. Although this plan introduces two new at-grade intersections for people who drive on Shaganappi Trail, it is anticipated that the roadway will continue to operate at acceptable levels of service with long term forecasted traffic in the study area.

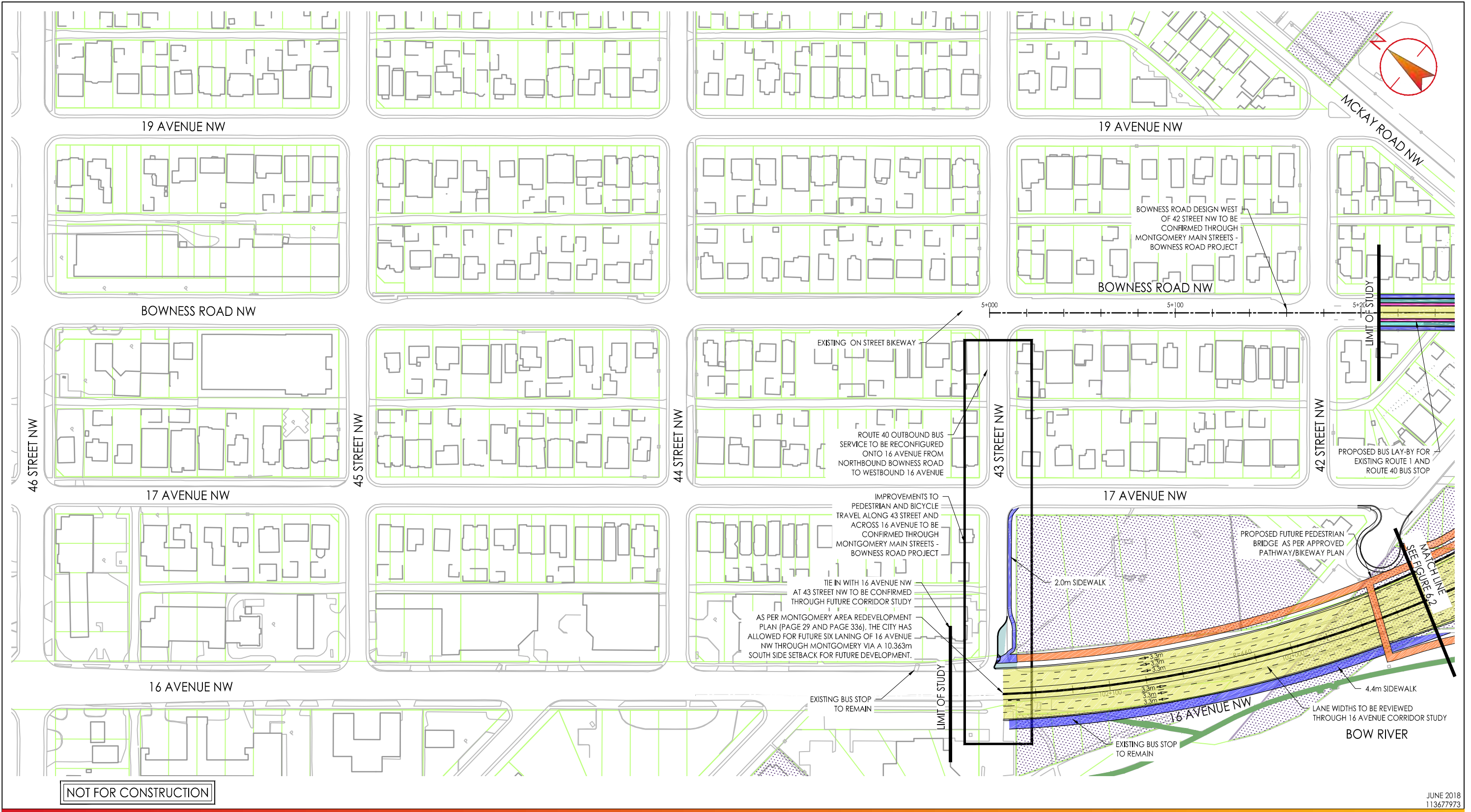

200-325 25th Street SE
Calgary AB
www.stantec.com

Legend

- ULTIMATE ROADWAY
- PROPOSED BRIDGE DECK
- CITY OWNED PROPERTY OUTSIDE ROAD ROW
- PROPOSED CONCRETE MEDIAN / NOSING
- PROPOSED SIDEWALK
- PROPOSED MULTI-USE PATHWAY
- PROPOSED CYCLE TRACKS
- PROPOSED BICYCLE LANE
- PROPOSED PARKING LANE
- PROPOSED CURB EXTENSION
- PROPOSED LANDSCAPING
- PROPOSED WATER PUMP STATION
- PROPOSED RETAINING WALL
- PROPOSED RESERVED CALGARY TRANSIT BUS LAY-BY
- EXISTING PATHWAY / SIDEWALK
- EXISTING PROPERTY LINE
- EXISTING BUILDINGS
- PROPOSED TRAFFIC SIGNALS
- EXISTING TRAFFIC SIGNALS

Scale:



Client/Project
THE CITY OF CALGARY
SOUTH SHAGANAPPI STUDY

Figure No.
6.1

Title
RECOMMENDED LONG TERM PLAN
16 AVENUE NW

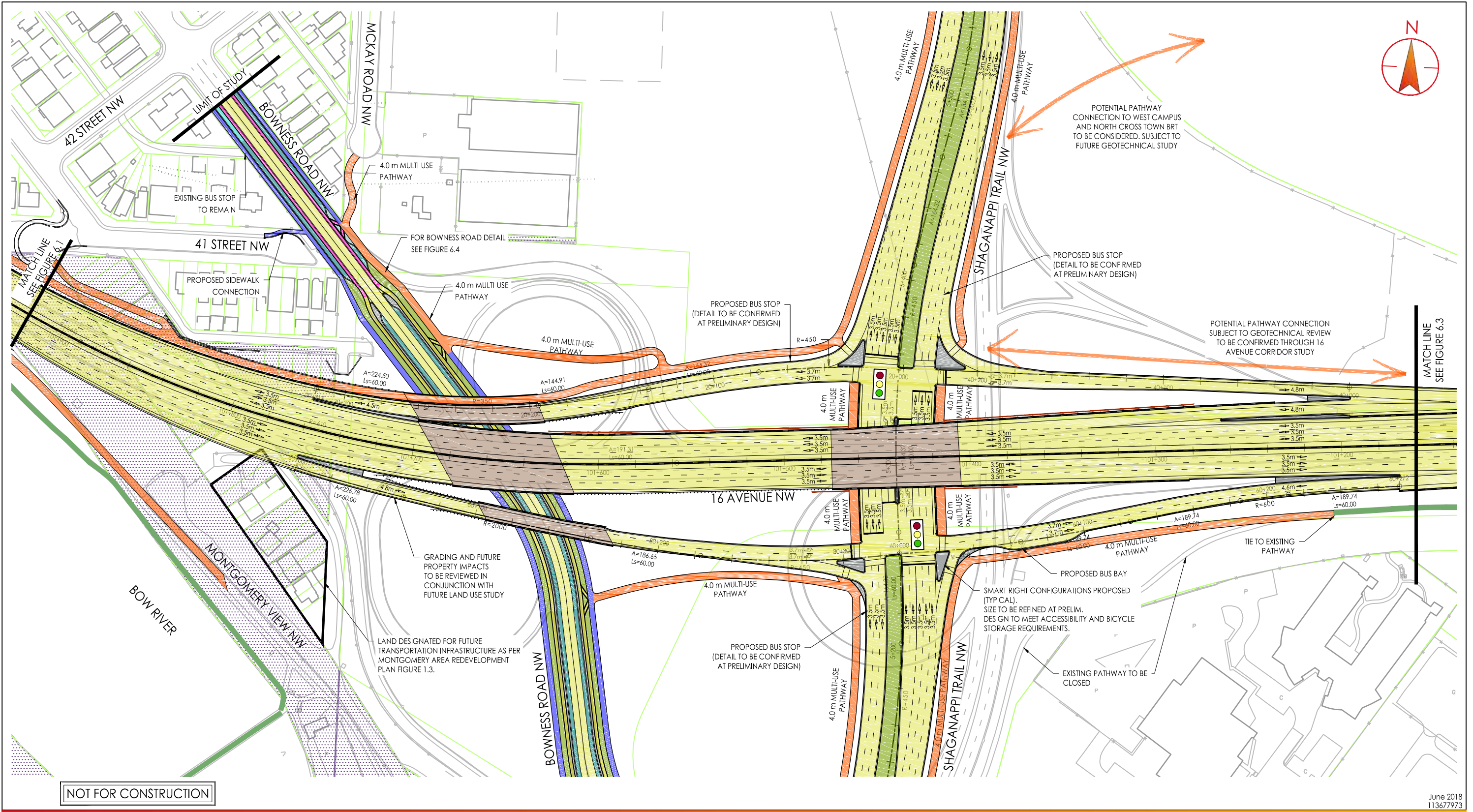

NOT FOR CONSTRUCTION

June 2018
113677973



200-325 25th Street SE
Calgary AB
www.stantec.com

Legend

- | | | | | | |
|--|--------------------------------------|--|--|--|--------------------------|
| | ULTIMATE ROADWAY | | PROPOSED PARKING LANE | | PROPOSED TRAFFIC SIGNALS |
| | PROPOSED BRIDGE DECK | | PROPOSED CURB EXTENSION | | EXISTING TRAFFIC SIGNALS |
| | CITY OWNED PROPERTY OUTSIDE ROAD ROW | | PROPOSED LANDSCAPING | | |
| | PROPOSED CONCRETE MEDIAN / NOSING | | PROPOSED WATER PUMP STATION | | |
| | PROPOSED SIDEWALK | | PROPOSED RETAINING WALL | | |
| | PROPOSED MULTI-USE PATHWAY | | PROPOSED RESERVED CALGARY TRANSIT BUS LAY-BY | | |
| | PROPOSED CYCLE TRACKS | | EXISTING PATHWAY / SIDEWALK | | |
| | PROPOSED BICYCLE LANE | | EXISTING PROPERTY LINE | | |
| | | | EXISTING BUILDINGS | | |

Scale:



Client/Project
THE CITY OF CALGARY
SOUTH SHAGANAPPI STUDY

Figure No.
6.2

Title
RECOMMENDED LONG TERM PLAN
16 AVENUE NW

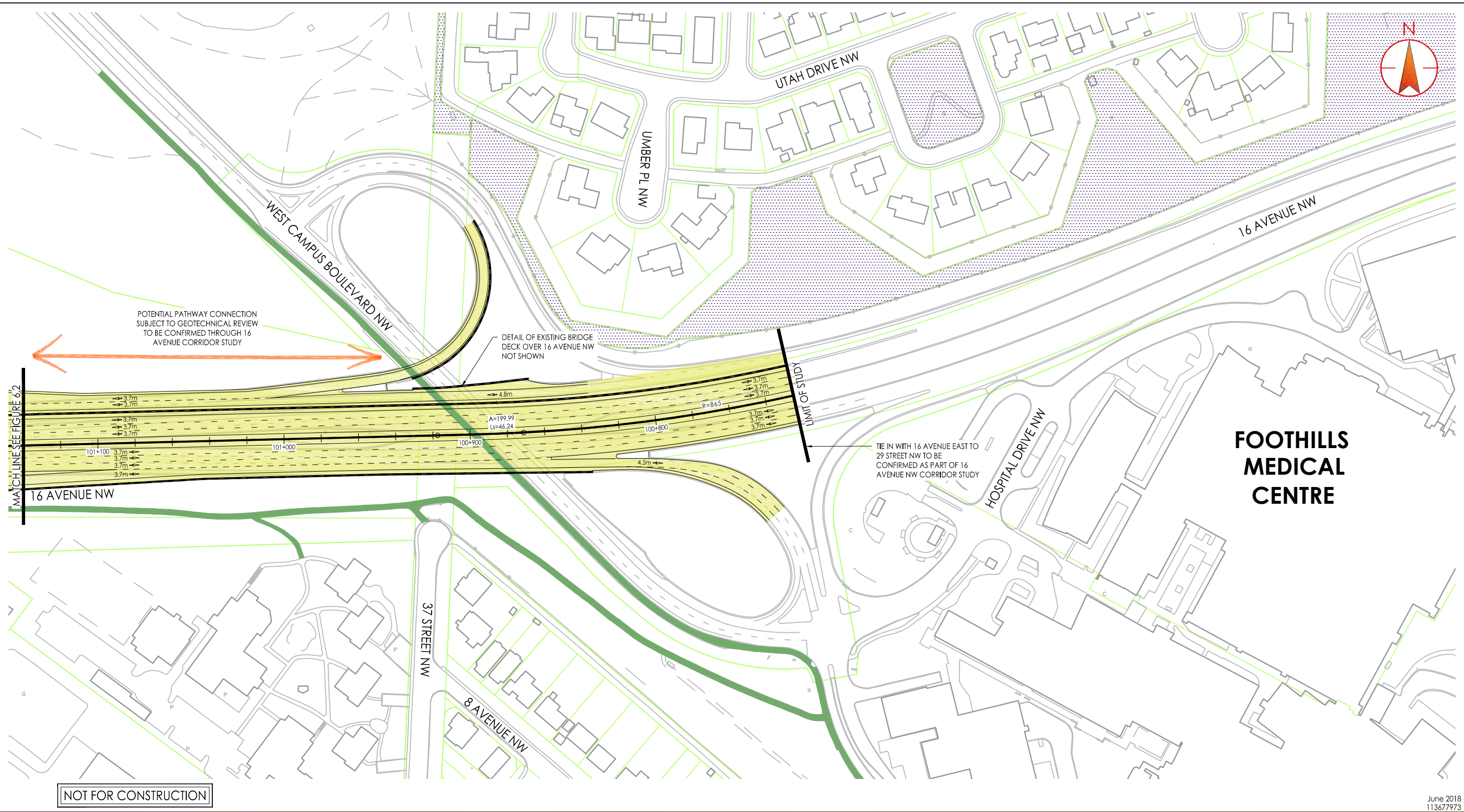

FOOTHILLS MEDICAL CENTRE



200-325 25th Street SE
Calgary AB
www.stantec.com

Legend

- | | | | | | |
|--|--------------------------------------|--|--|--|--------------------------|
| | ULTIMATE ROADWAY | | PROPOSED PARKING LANE | | PROPOSED TRAFFIC SIGNALS |
| | PROPOSED BRIDGE DECK | | PROPOSED CURB EXTENSION | | EXISTING TRAFFIC SIGNALS |
| | CITY OWNED PROPERTY OUTSIDE ROAD ROW | | PROPOSED LANDSCAPING | | |
| | PROPOSED CONCRETE MEDIAN / NOSING | | PROPOSED WATER PUMP STATION | | |
| | PROPOSED SIDEWALK | | PROPOSED RETAINING WALL | | |
| | PROPOSED MULTI-USE PATHWAY | | PROPOSED RESERVED CALGARY TRANSIT BUS LAY-BY | | |
| | PROPOSED CYCLE TRACKS | | EXISTING PATHWAY / SIDEWALK | | |
| | PROPOSED BICYCLE LANE | | EXISTING PROPERTY LINE | | |
| | | | EXISTING BUILDINGS | | |

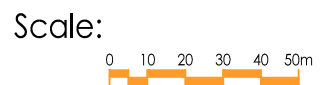

Client/Project
THE CITY OF CALGARY
SOUTH SHAGANAPPI STUDY

Figure No.
6.3

Title
RECOMMENDED LONG TERM PLAN
16 AVENUE NW

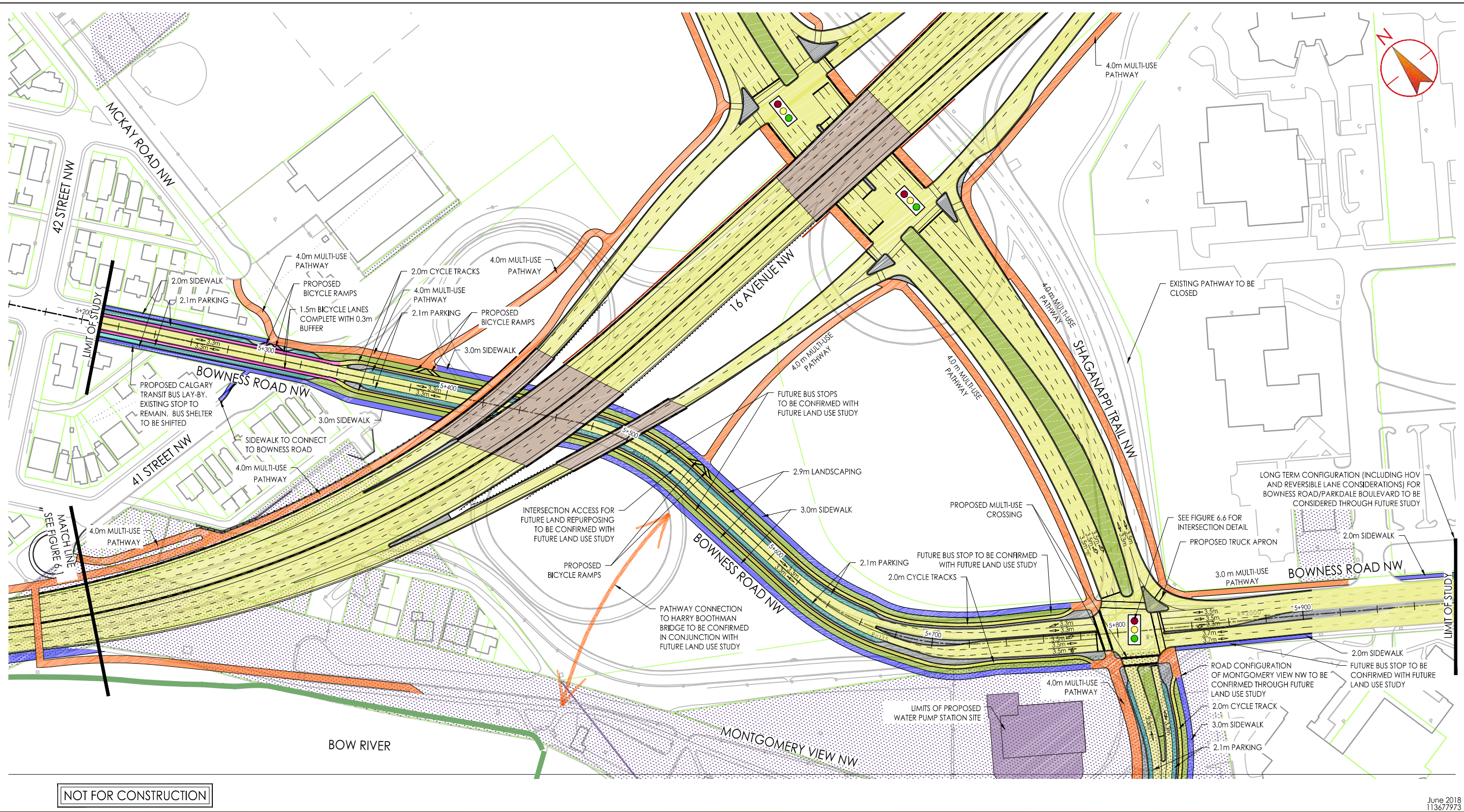

NOT FOR CONSTRUCTION

June 2018
113677973



200-325 25th Street SE
Calgary AB
www.stantec.com

Legend

- | | | | | | |
|--|--------------------------------------|--|--|--|--------------------------|
| | ULTIMATE ROADWAY | | PROPOSED PARKING LANE | | PROPOSED TRAFFIC SIGNALS |
| | PROPOSED BRIDGE DECK | | PROPOSED CURB EXTENSION | | EXISTING TRAFFIC SIGNALS |
| | CITY OWNED PROPERTY OUTSIDE ROAD ROW | | PROPOSED LANDSCAPING | | |
| | PROPOSED CONCRETE MEDIAN / NOSING | | PROPOSED WATER PUMP STATION | | |
| | PROPOSED SIDEWALK | | PROPOSED RETAINING WALL | | |
| | PROPOSED MULTI-USE PATHWAY | | PROPOSED RESERVED CALGARY TRANSIT BUS LAY-BY | | |
| | PROPOSED CYCLE TRACKS | | EXISTING PATHWAY / SIDEWALK | | |
| | PROPOSED BICYCLE LANE | | EXISTING PROPERTY LINE | | |
| | | | EXISTING BUILDINGS | | |

Scale:

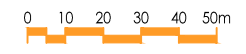

Client/Project
THE CITY OF CALGARY
SOUTH SHAGANAPPI STUDY

Figure No.
6.4

Title
RECOMMENDED LONG TERM PLAN
BOWNESS ROAD NW

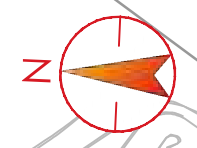
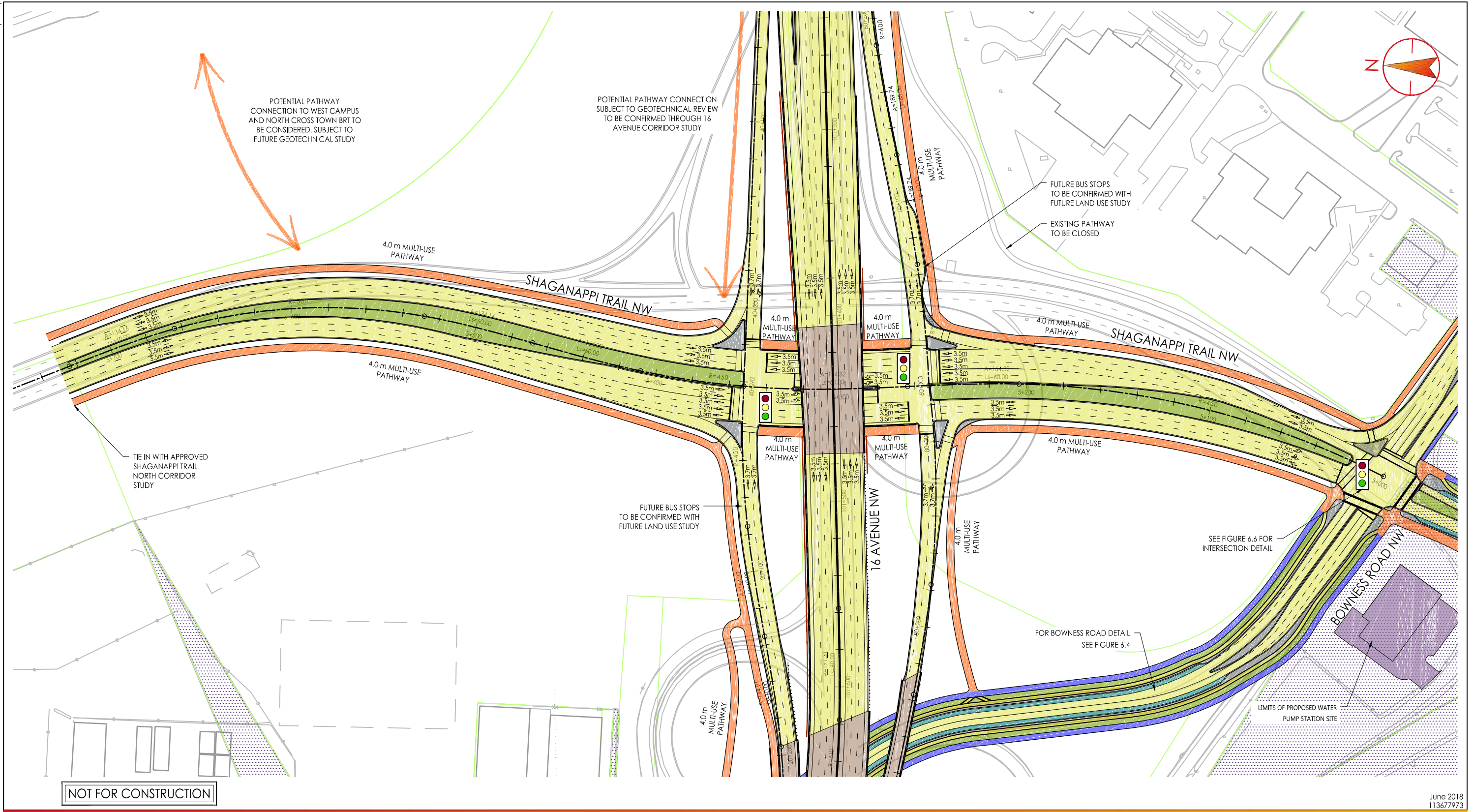





















NOT FOR CONSTRUCTION

June 2018
113677973



200-325 25th Street SE
Calgary AB
www.stantec.com

Legend

- | | | | | | |
|---|--------------------------------------|---|--|---|--------------------------|
|  | ULTIMATE ROADWAY |  | PROPOSED PARKING LANE |  | PROPOSED TRAFFIC SIGNALS |
|  | PROPOSED BRIDGE DECK |  | PROPOSED CURB EXTENSION |  | EXISTING TRAFFIC SIGNALS |
|  | CITY OWNED PROPERTY OUTSIDE ROAD ROW |  | PROPOSED LANDSCAPING |  | |
|  | PROPOSED CONCRETE MEDIAN / NOSING |  | PROPOSED WATER PUMP STATION | | |
|  | PROPOSED SIDEWALK |  | PROPOSED RETAINING WALL | | |
|  | PROPOSED MULTI-USE PATHWAY |  | PROPOSED RESERVED CALGARY TRANSIT BUS LAY-BY | | |
|  | PROPOSED CYCLE TRACKS |  | EXISTING PATHWAY / SIDEWALK | | |
|  | PROPOSED BICYCLE LANE |  | EXISTING PROPERTY LINE | | |
| | |  | EXISTING BUILDINGS | | |

Scale:



Client/Project
THE CITY OF CALGARY
SOUTH SHAGANAPPI STUDY

Figure No.
6.5

Title
RECOMMENDED LONG TERM PLAN
SHAGANAPPI TRAIL NW

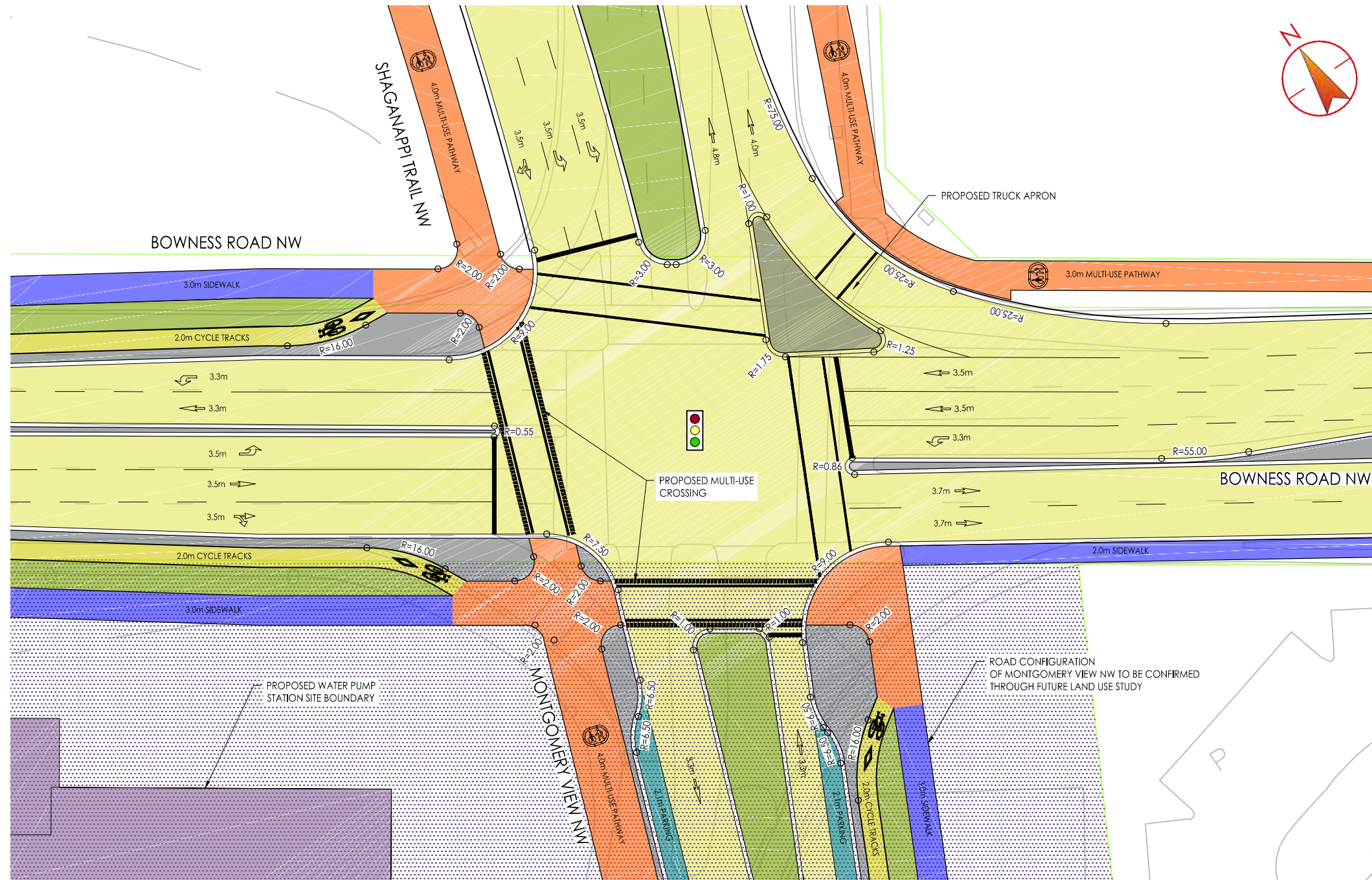

BOWNESS ROAD NW AND SHAGANAPPI TRAIL NW INTERSECTION DETAILS

NOT FOR CONSTRUCTION

JUNE 2018
113677973



200-325 25th Street SE
Calgary AB
www.stantec.com

Legend

- | | | | | | |
|--|--------------------------------------|--|--|--|--------------------------|
| | ULTIMATE ROADWAY | | PROPOSED PARKING LANE | | PROPOSED TRAFFIC SIGNALS |
| | PROPOSED BRIDGE DECK | | PROPOSED CURB EXTENSION | | EXISTING TRAFFIC SIGNALS |
| | CITY OWNED PROPERTY OUTSIDE ROAD ROW | | PROPOSED LANDSCAPING | | EXISTING TRAFFIC SIGNALS |
| | PROPOSED CONCRETE MEDIAN / NOSING | | PROPOSED WATER PUMP STATION | | |
| | PROPOSED SIDEWALK | | PROPOSED RETAINING WALL | | |
| | PROPOSED MULTI-USE PATHWAY | | PROPOSED RESERVED CALGARY TRANSIT BUS LAY-BY | | |
| | PROPOSED CYCLE TRACKS | | EXISTING PATHWAY / SIDEWALK | | |
| | PROPOSED BICYCLE LANE | | EXISTING PROPERTY LINE | | |
| | | | EXISTING BUILDINGS | | |

Scale:



Client/Project
THE CITY OF CALGARY
SOUTH SHAGANAPPI STUDY

Figure No.
6.6

Title
INTERSECTION DETAIL
LONG TERM PLAN BOWNESS ROAD NW AT
SHAGANAPPI TRAIL NW

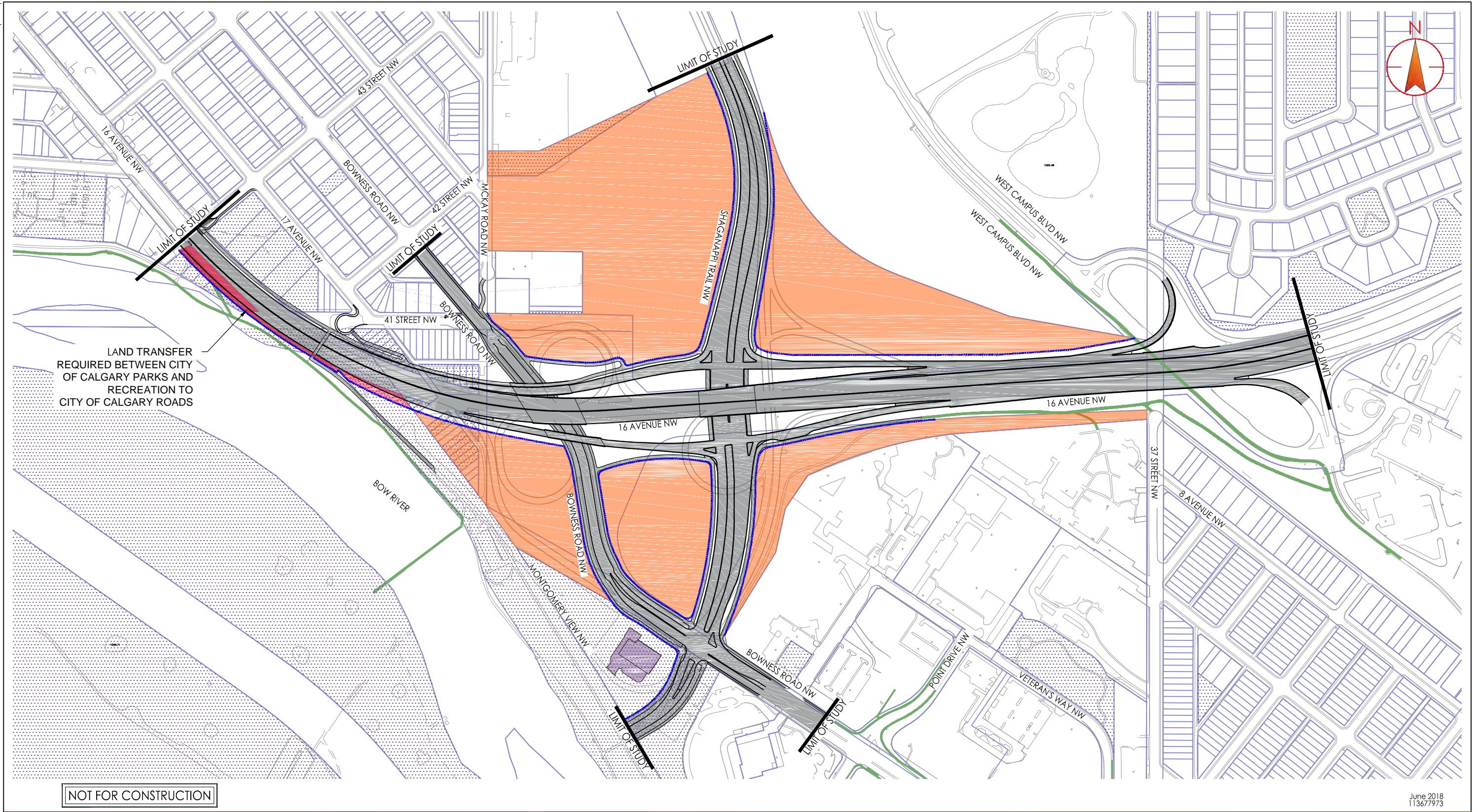

LAND TRANSFER
REQUIRED BETWEEN CITY
OF CALGARY PARKS AND
RECREATION TO
CITY OF CALGARY ROADS









NOT FOR CONSTRUCTION

June 2018
113677973



200-325 25th Street SE
Calgary AB
www.stantec.com

Legend

-  PROPOSED LONG TERM TRANSPORTATION INFRASTRUCTURE
-  CITY OWNED PROPERTY OUTSIDE ROAD ROW
-  LAND NO LONGER REQUIRED FOR TRANSPORTATION INFRASTRUCTURE
-  PROPOSED WATER PUMP STATION
-  EXISTING PATHWAY / SIDEWALK
-  PROPOSED LAND TRANSFER
-  EXISTING PROPERTY LINE
-  PROPOSED PROPERTY LINE

Scale:



Client/Project
THE CITY OF CALGARY
SOUTH SHAGANAPPI STUDY

Figure No.
Fig. 6.7

Title
LAND NO LONGER REQUIRED FOR
TRANSPORTATION INFRASTRUCTURE - LONG TERM

SOUTH SHAGANAPPI STUDY

Recommended Concept

With the proposed reconfiguration of the study area in the long term, there will be a number of changes for how people travel through the study area. New turning manoeuvres that will be introduced and existing turning movements will be refined to a more concise configuration upon implementation of the ultimate plan.

6.1.2 Recommended Roadway Configurations

6.1.2.1 Shaganappi Trail

Shaganappi Trail will function as an Arterial Road south of Crowchild Trail, as per the CTP.

Shaganappi Trail will tie in with the approved Shaganappi Trail Corridor and HOV Study terminus south of West Campus Way. This study recommended a six lane cross section, which will continue south to the junction of 16 Avenue and Shaganappi Trail. Consistent with the North Shaganappi Study, a multi-use pathway will be provided on both sides of Shaganappi Trail to facilitate mobility for people who walk, roll, and bicycle.

Dual left turning lanes are recommended in both the northbound and southbound direction to accommodate access onto 16 Avenue in both the westbound and eastbound direction.

Between 16 Avenue and Bowness Road, Shaganappi Trail will maintain a three lane cross section in the southbound direction. In the northbound direction, Shaganappi Trail reduces to a two lane cross section.

It has been recommended to realign Shaganappi Trail approximately 50m west of its current location. This is necessary to accommodate the minimum vertical grade of 4% through the at-grade intersections. It also provides a benefit by reducing the impact at the time of construction by enabling efficient detour staging and bridge construction.

6.1.2.2 16 Avenue

16 Avenue will tie in at 43 Street with a six lane cross section, median, and concrete curb and gutter on both sides of the roadway. 16 Avenue will function as a Skeletal Road within the study area, as per the CTP. Pedestrian and bicycle accommodation is proposed with multi-use pathways on both the north and south sides of 16 Avenue. The configuration of these pathways is described further in **Section 6.2**.

Between 43 Street and Bowness Road, 16 Avenue will follow a 2.50% grade in order to provide a 5.7m clearance over Bowness Road. Access ramps to and from Shaganappi Trail terminate west of Bowness Road in order to provide sufficient ramp lengths. As such, separate bridge structures over Bowness Road are provided for 16 Avenue, eastbound 16 Avenue off Ramp, and westbound 16 Avenue on ramp.

Between 43 Street and Bowness Road, the cross section transitions from a 0.25m standard concrete curb and gutter to a 0.50m rollover concrete curb and gutter with a 3.50m shoulder on both sides of the road.

Between Bowness Road and Shaganappi Trail, the six lane cross section continues, with a bridge crossing over Shaganappi Trail. Off ramps and on ramps tie between 16 Avenue and Shaganappi Trail.

16 Avenue ties in with existing roadway grades approximately 300m east of the existing Shaganappi Trail centreline.

SOUTH SHAGANAPPI STUDY

Recommended Concept

Lane widths of 3.50 m were carried through the study area to align with the existing lane widths on 16 Avenue at the West Campus Boulevard interchange. There is a transition from 3.50 m to 3.30 m lane widths between the west terminus of the 16 Avenue / Shaganappi Trail interchange and the intersection of 43 Street. This transition was provided in order to align with the Urban Boulevard classification of 16 Avenue west of 43 Street.

It is noted that the lane widths should be revisited as part of the 16 Avenue Corridor Study to ensure there is consistency and integration with 16 Avenue to the west and to the east of the study area.

6.1.2.3 Bowness Road

Bowness Road will function as a Neighbourhood Boulevard west of Shaganappi Trail. This is a modification from the CTP, which maintains Bowness Road a Parkway classification between Shaganappi Trail and 41 Street. Since access is not maintained between 16 Avenue and Bowness Road within the ultimate roadway configuration, the arterial roadway classification is not needed.

Consistent with The Complete Streets Guidelines, Bowness Road will maintain a two motor vehicle lane cross section, with parking on both sides, and flexibility for the introduction of turn lanes dependent on future land repurposing decisions that are made within the study area.

Between Shaganappi Trail and 41 Street, accommodation for bicycles will be provided by two uni-directional cycle tracks, separated by a concrete median from the parking lane. A landscaped boulevard and sidewalk are recommended on both sides of Bowness Road, consistent with the Complete Streets Guidelines.

Between 41 Street and 42 Street, accommodation for bicycles will transition to marked bicycle lanes due to existing road right of way constraints.

Consistent with the short term investment recommendations, the tie in at 42 Street will need to be confirmed with the outcomes of the Montgomery Main Streets – Bowness Road project that is currently underway.

6.2 PEDESTRIAN/CYCLIST FACILITIES

People who walk or people who use wheelchairs, strollers, or bicycles within the study area are provided with flexibility and numerous route choices to access local and regional destinations near by to the study area. In particular, improved connections are provided to the University District, the Foothills Medical Centre, Point McKay, Parkdale, Montgomery, and Edworthy Park.

Specific improvements recommended are summarized as follows:

- Sidewalk connections on both sides of Bowness Road between 42 Street and Shaganappi Trail.
- Bicycle accommodation on both sides of Bowness Road between 42 Street and Shaganappi Trail.
- Multi-use pathway connection between Bowness Road and Mackay Road.
- Multi-use pathway connection on both sides of Shaganappi Trail between West Campus Way and Bowness Road.
- Multi-use Pathway connection on the north side of 16 Avenue between 43 Street and Shaganappi Trail.
- Multi-use pathway connection on the south side of 16 Avenue between Bowness Road and West Campus Boulevard.
- New pedestrian bridge over 16 Avenue connecting 43 Street with the Bow River Pathway.

SOUTH SHAGANAPPI STUDY

Recommended Concept

Additionally, the following routes have been identified for further evaluation:

- Connection between Bowness Road and Harry Boothman bridge to be reviewed in conjunction with future land use study.
- Connection on north side of 16 Avenue between Shaganappi Trail and West Campus Boulevard subject to future study.
- Connection between Shaganappi Trail and University District (including North Cross Town BRT Stop) subject to future study.
- Alternate pedestrian underpass connection in place of recommended pedestrian overpass connecting 16 Avenue/43 Street to Edworthy Park to be reviewed at implementation stage.

6.3 TRANSIT

The recommended plan allows for future transit operation on 16 Avenue, Shaganappi Trail, and Bowness Road. There is flexibility for all existing routes to be maintained, with the exception of Route 40 which will no longer be able to access southbound Bowness Road directly from eastbound 16 Avenue. This route would be realigned to access Bowness Road from Shaganappi Trail.

Allowance for bus stops have been made in both the northbound and southbound direction on Shaganappi Trail at 16 Avenue, as well as eastbound and westbound on 16 Avenue at the ramp intersections with Shaganappi Trail. These bus stops could accommodate potential future transit service on Shaganappi Trail and/or 16 Avenue.

Dependent on future studies, additional bus stops could be introduced on Bowness Road between Shaganappi Trail and 42 Street.

A transit priority signal treatment is recommended for eastbound buses on Bowness Road at Shaganappi Trail. This will provide for greater travel time reliability for passengers traveling on Route 1 and Route 305.

6.4 HIGH-OCCUPANCY VEHICLES (HOV)

The Shaganappi Trail Corridor and HOV Study provided a long term recommendation for high occupancy vehicle accommodation between Crowchild Trail and West Campus Way. North of Crowchild Trail, the plan recommended that HOV accommodation should not be included in the long term. The Calgary Transportation Plan provided a recommended HOV Network (as per **Figure 1.7**) which includes Bowness Road south of 16 Avenue, Shaganappi Trail south to 16 Avenue, and 16 Avenue through the study area. There has been no further advancement of geometric recommendations for the accommodation of HOV Facilities on these roadways. Further, the North Crosstown BRT project did not incorporate any HOV facilities.

The South Shaganappi Study has allowed for a six lane configuration on Shaganappi Trail to tie in with the HOV Lanes identified as part of the Shaganappi Trail Corridor Study & HOV Plan. However, there was insufficient clarity on the future intended HOV accommodation for 16 Avenue and Bowness Road to provide recommendation on the appropriate geometric transitions between these facilities.

As such, it is recommended that the HOV accommodation and transitions be reviewed and confirmed upon completion of The City's HOV Network Study.

6.5 TRAFFIC ANALYSIS

The 2048 horizon was selected for use in the traffic analysis. The 2048 forecast traffic volumes provided by The City were modified to better reflect the University District development and the Calgary Cancer Centre. All traffic volumes and results of the operational evaluation are shown in **Appendix K**.

The preferred 16 Avenue / Shaganappi Trail interchange is anticipated to operate acceptably at the north and south ramp terminals. It is anticipated that there may be operational challenges at the intersection of Shaganappi Trail and Bowness Road. These challenges were identified based on the algorithms and assumptions embedded within The City's Emme2 Transportation Model which identified increased traffic volumes on Bowness Road east of Shaganappi Trail.

Acknowledging the project objectives, the intent of the preferred concept is to maintain traffic on 16 Avenue. Together with the approved upgrades planned for Crowchild Trail, an evaluation was undertaken to assess how a redistribution of traffic from 16 Avenue-Bowness Road-Parkdale Boulevard-Crowchild Trail to 16 Avenue-Crowchild Trail would operate. It was determined that with a diversion of 20% traffic volumes, the intersections within the study area are expected to operate at an acceptable level of service and with acceptable queues.

Several modifications to the preferred concept at the Shaganappi Trail / Bowness Road intersection were considered to improve traffic operations should this diversion not occur. These alternative configurations were developed while being mindful of the overall project objectives. Should a modification to the preferred concept be required to accommodate the 2048 traffic volumes with no diversion, the best option that addresses the operational deficiencies at the Shaganappi Trail / Bowness Road intersection is modifying the intersection to a T-intersection as shown in **Figure 6.8**. However, this modification would compromise the pedestrian and bicycle mobility in this area, and is therefore not recommended unless warranted by traffic volumes observed and anticipated at the time the project is funded.



NOT FOR CONSTRUCTION



UTAH DR NW

PRECISE DETAILS REGARDING ALIGNMENT AND CONNECTIONS TO BE DETERMINED AS PART OF A FUTURE STUDY

June 2018
113677973

U:\113677973\07_cad\sheet_files\91_sketch\sk-019_tudl_bow-rd_intersection_opt1.dwg
2018/06/12 3:10 PM By: Wiebe, Brian

LEGEND

- ROADWAYS
- PROPOSED PROPERTY LINE
- EXISTING PROPERTY LINE
- 4 NUMBER OF LANES
- PROPOSED BRIDGE

Client/Project
**THE CITY OF CALGARY
SOUTH SHAGANAPPI
CORRIDOR STUDY**

Figure No.
6.8

Title
**BOWNESS ROAD / SHAGANAPPI TRAIL
CAPACITY IMPROVEMENTS
RIGHT-IN/RIGHT-OUT**



SOUTH SHAGANAPPI STUDY

Recommended Concept

6.6 UTILITY ASSESSMENT

This section of the report describes potential short and long term conflicts between the proposed road upgrades and the water and sanitary sewer utilities within the study corridor.

6.6.1 Water

The 1,950mm diameter concrete feedermain, which is currently under 16 Avenue (west end of study corridor) may not require modifications as the proposed road upgrades will not place significant fill over top of the existing pipe, and since the pipe is already inside the roadway, it is assumed that keeping it at the same location after the roads upgrades are complete is acceptable. Communication and coordination with Water Resources at the time of preliminary design is required to confirm the condition of this pipe and if replacement is required due to reasons outside of the road upgrades.

The 250mm diameter ductile iron pipe located at the west end of Bowness Road and crossing 16 Avenue may require removal and re-installation with encasement. It should also be confirmed with Water Resources when the watermain is scheduled to be upgraded so that this work can be done prior to or as a part of road upgrades work.

The existing 1,200mm diameter concrete water feedermain that runs parallel to 16 Avenue along the south side (east end of the study corridor) is not expected to be impacted by widening of 16 Avenue; however, consideration should be provided to the fact that this line is in close proximity to the road widening at this location and may potentially fall under heavy construction traffic and may require protection or relocation. The 500mm diameter asbestos cement (AC) watermain crossing 16 Avenue may have to be replaced due to its material and should be installed within an encasement. This can be reviewed with Water Resources to confirm any scheduled upgrades so that this work can be done prior to or as a part of Shaganappi interchange work.

It is understood that The City of Calgary Water Resources is planning to relocate the existing water pump station located at north side of the Bowness Road west of Point Drive to the green space at the southwest corner of Shaganappi Trail and Bowness Road intersection. This facility relocation requires relocation of major water feedermain pipes as illustrated on **Figure 6.9**. It is understood this work is planned to proceed ahead of the road upgrades associated to the Shaganappi Trail interchange.

In the comments from Water Resources, dated September 16, 2016 provided for the South Shaganappi Feedermain Study concept option submission, it was noted that Water Resources identified a future South Shaganappi Feedermain tie upgrade that is in the vicinity of 16 Avenue and Bowness Road interchange (See **Figure 6.9**). Coordination will be required at the time of planned upgrades to address any utility crossing requirements of the proposed concept. Future crossing of major roadways such as 16 Avenue and Bowness Road is anticipated to be via trenchless methods.

Figure 6.9 illustrates the identified conflicts of existing and known planned waterworks infrastructure within the study corridor.

ORIGINAL SHEET - ANS B (11x17)

U:\113677973\07_cod\sheet_files\92_figure\functional_report\113677973_du_1.0.dwg
2018/04/26 1:57 PM By: Wiebe, Brian

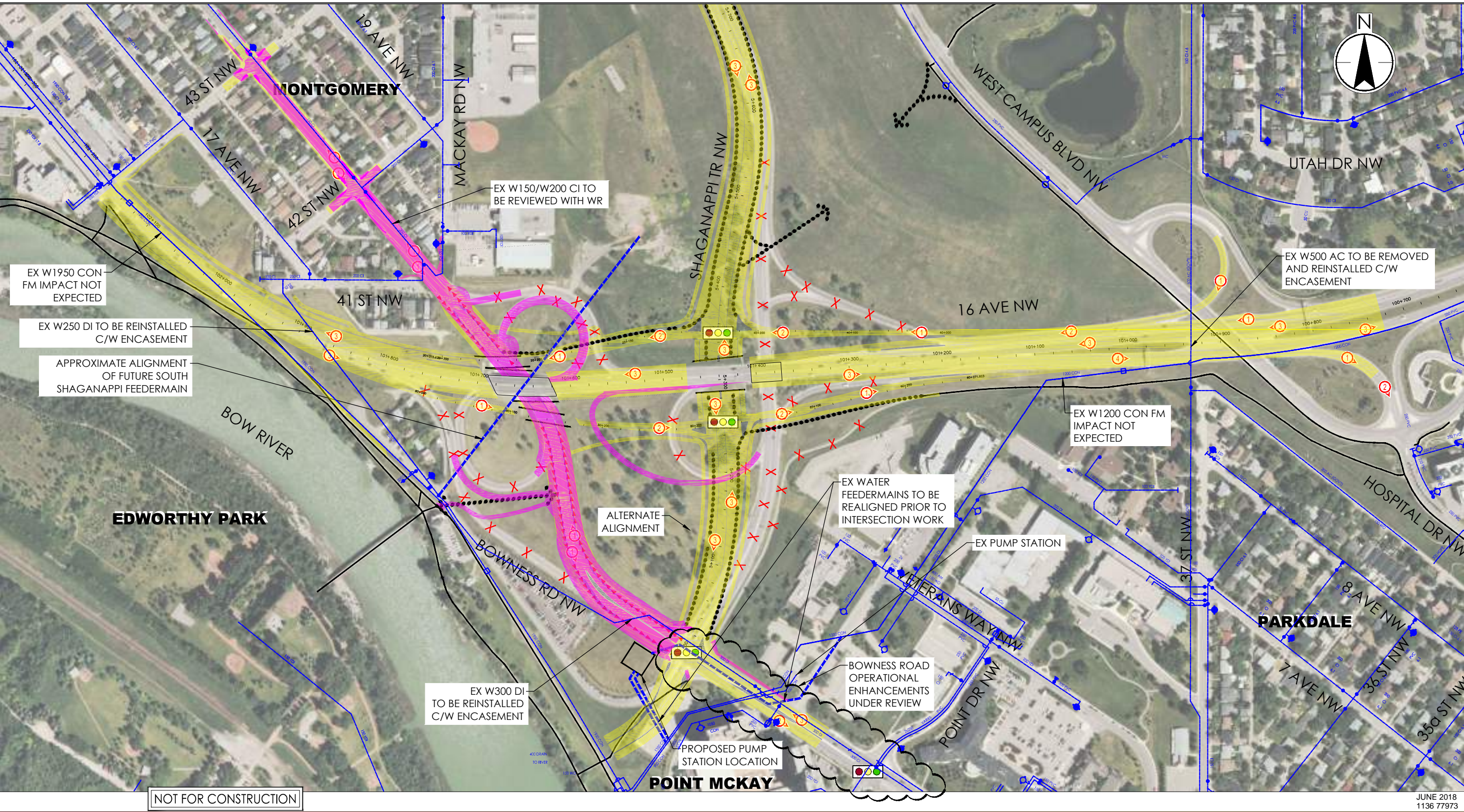

NOT FOR CONSTRUCTION

JUNE 2018
1136 77973



200-325 25th Street SE
Calgary AB
www.stantec.com

Legend		Scale: 1:4000	
	PROPOSED PATHWAY		FUTURE CLOSED ROAD
	PROPOSED PROPERTY LINE		EXISTING PATHWAY
	EXISTING PROPERTY LINE		NUMBER OF LANES
	SHORT TERM ROADWAY UPGRADE		PROPOSED BRIDGE
	LONG TERM ROADWAY UPGRADE		PROPOSED WATER MAIN
			PROPOSED PROTECTED BIKE LANE
			EXISTING SIGNAL
			PROPOSED SIGNAL
			PROPOSED BARRIER
			EXISTING WATER MAIN

Client/Project
THE CITY OF CALGARY
SOUTH SHAGANAPPI STUDY

Figure No.
6.9

Title
WATER UTILITY ASSESSMENT

SOUTH SHAGANAPPI STUDY

Recommended Concept

6.6.2 Sanitary Sewer

The 525mm and 250mm diameter concrete sanitary sewer crossing 16 Avenue at the west end of Bowness Road should not require upgrades or replacement as road grades at this location will not change significantly, however this should be reviewed and confirmed during preliminary design. Consultation with Water Resources will be required to confirm sewer condition and any need for upgrades independent of the transportation infrastructure.

Water Resources identified a need to twin the 1,500mm diameter sanitary trunk along 16 Avenue and Bowness Road, called the Shouldice Sanitary Trunk upgrade. This project is still in conceptual stages of design, but it does cross the corridor study and has the potential to impact the Shaganappi Trail interchange work. Further coordination with Water Resources should be undertaken in conjunction with the preliminary design of both projects to confirm the alignment of the sanitary trunk twinning and undertake optimization to ensure it aligns with the recommended interchange configuration.

The 450mm diameter PVC sanitary main that flows south crossing 16 Avenue will not conflict with the interchange work since the pipe is encased and the work on the new ramps from 16 Avenue are close to existing grade. The 450mm diameter PVC sanitary main flows into a 525mm diameter concrete main that flows west along the proposed eastbound 16 Avenue ramp to a manhole located on Shaganappi Trail. Similarly, this section of pipe will not conflict with the proposed ramp since the ramp will be close to existing grade but should be encased across proposed ramp to facilitate future maintenance. The pipe then flows south along Shaganappi Trail before turning west and crossing under the proposed Shaganappi Trail realignment before it flows into the 1,500mm diameter sanitary trunk. The crossings under the proposed Shaganappi Trail realignment will not conflict since the proposed road work is close to existing grade but should be encased to facilitate future maintenance.

The 375mm diameter concrete sewer that flows in the north-south direction, and crosses 16 Avenue west of West Campus Boulevard is also anticipated to be in reasonable condition, however consultation with Water Resources is required to confirm this along with potential encasement to facilitate future maintenance.

Figure 6.10 illustrates the identified conflicts of existing and known planned sanitary sewer infrastructure within the study corridor.

ORIGINAL SHEET - ANS B (11x17)

U:\113677973\07_cad\sheet_files\92_figure\functional_report\113677973_du_2.0.dwg
2018/04/26 12:43 PM By: Wiebe, Brian

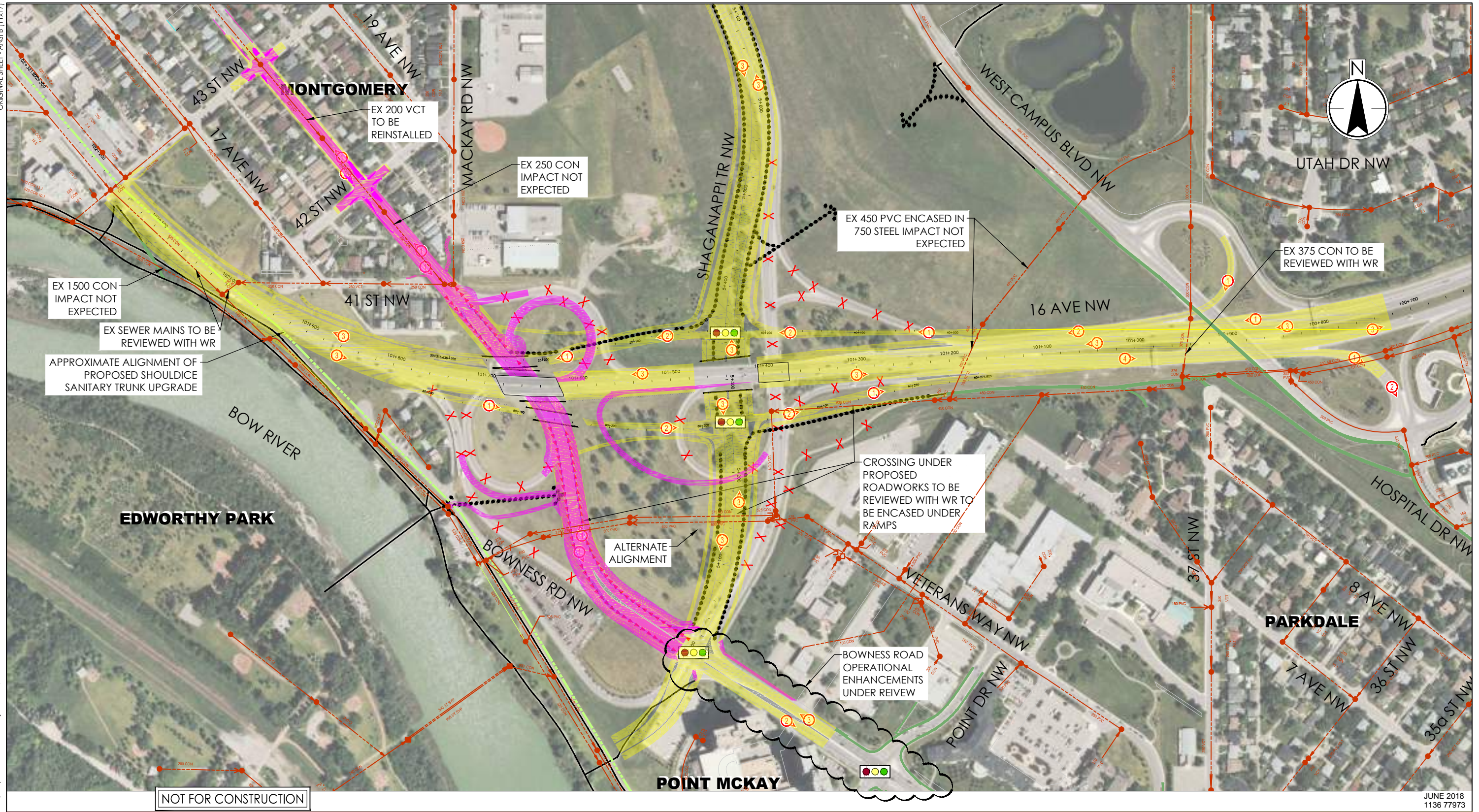

NOT FOR CONSTRUCTION

JUNE 2018
1136 77973



200-325 25th Street SE
Calgary AB
www.stantec.com

Legend					
	PROPOSED PATHWAY		FUTURE ROAD CLOSED		PROPOSED PROTECTED BIKE LANE
	PROPOSED PROPERTY LINE		EXISTING PATHWAY		EXISTING SIGNAL
	EXISTING PROPERTY LINE		NUMBER OF LANES		PROPOSED SIGNAL
	SHORT TERM ROADWAY UPGRADE		PROPOSED BRIDGE		PROPOSED BARRIER
	LONG TERM ROADWAY UPGRADE		EXISTING SANITARY SEWER		PROPOSED SHOULDICE SANITARY TRUNK UPGRADE

Scale: 1:4000
0 10 25 50 75 100m

Client/Project
THE CITY OF CALGARY
SOUTH SHAGANAPPI STUDY

Figure No.
6.10

Title
SANITARY UTILITY ASSESSMENT

SOUTH SHAGANAPPI STUDY

Recommended Concept

6.6.3 Shallow Utilities

There are several underground ATCO Gas line segments located throughout the corridor, these facilities are located on the north side of 16 Avenue, crossing 16 Avenue on the west side of the study area and running on the north side of Bowness Road. Coordination with ATCO Gas will be needed at the time of preliminary design to confirm if these facilities will need to be relocated or protected in place depending on the minimum depth of cover that is achievable.

There is an ATCO Pipelines facility located on the west side of the study area. This should require Hydrovac at the time of preliminary design to determine the depth of cover and if relocation is required based on final design grades for the roadway.

Enmax overhead power lines run on the south side of the 16 Avenue to the existing Bowness Road access ramp and continue east on Bowness Road / Parkdale Boulevard. These poles also support telecom wires. Poles and wires will have to be relocated for the proposed roadworks if they have not been relocated as part of short term modifications undertaken.

Enmax also has an underground cable that runs on the west side of Shaganappi Trail, south of 16 Avenue that appears to service the existing street lighting system. This facility will need be salvaged completely or modified for the new street lighting configuration.

6.7 STORMWATER MANAGEMENT ASSESSMENT

A preliminary stormwater management analysis was undertaken to understand the implications of the proposed concept on stormwater infrastructure within the study area.

It was determined that the preferred concept increases the impervious cover in the study boundary by approximately 2.8 ha, triggering the requirement of extra stormwater storage onsite and management of peak flow rates to existing storm sewer capture locations in the study area. A detailed stormwater management plan complete with a geotechnical investigation should be undertaken at the time of preliminary design to confirm infrastructure requirements. However, based on the preliminary analysis undertaken based on the 1:100-year, 24-hour duration storm event, the following requirements are anticipated:

- Realign, remove and modify infrastructure identified in **Table 6-1** and depicted in **Figure 6.11**;
- Maximize routing of impervious area runoff through greenspaces prior to minor system capture using curb cuts, culverts, inlet pipes that daylight to greenspaces, and roadway grading promoting traplow spillways to greenspaces and other onsite storage depressions;
- Twin Type C flow-by CBs accepting drainage from proposed sub-catchments PC6 and PC7;
- Provide 4-Twin CBs in Shaganappi Trail below 16 Avenue crossing in proposed traplow. Additional storage in traplow compared to the existing condition may also be required;
- Provide additional K3 CB in Bowness road below 16 Avenue crossing in existing traplow;

SOUTH SHAGANAPPI STUDY

Recommended Concept

- Install ICD to control flow from proposed stormwater depression (and potential future pond) in greenspace west of Bowness Road and South of 16 Avenue to approximately 63 L/s;
- Modify and realign the existing dry pond southeast of the 16 Avenue and Shaganappi Trail interchange. Storage provided should be equivalent to existing storage available, estimated at 1217 m³, with the previously designed flow restriction of 954 L/s (R250 ICD). Storage requirements should be confirmed at detailed design stage, since the previous design (Stantec, 2005) indicated a design volume of 2078 m³. An OGS unit should be provided downstream to remove 85% of total suspended solids 50 microns or larger;
- Provide additional depression storage volumes in study boundary in roadways and greenspaces in the order of 1169 m³ for the proposed condition. Detailed design of the storage facilities, particularly in the greenspace identified in the southwest of 16 Avenue and Bowness Trail crossing, will be required at the detailed design stage.
- Provide mechanical removal of oil-grit and debris downstream stormwater facility IDs 400076176, 620013700 & 620013848, which respectively are the modified dry pond in the southeast corner of 16 Avenue and Shaganappi Trail, the traplow on Shaganappi trail below the 16 Avenue overpass, and the greenspace depression east of Bowness road and south of 16 Avenue. This can be accomplished with OGS units and/or catch basin anti-syphon hoods that remove oil-grit and debris at the detailed design stage.

Ultimately, should recommendations be followed in this study, the preferred concept proposed can meet the objectives of the design and City of Calgary requirements.

SOUTH SHAGANAPPI CORRIDOR STUDY

Site Stormwater Impacts
June 2018

Table 6-1 Existing Stormwater Infrastructure Modification & Removals

Drawing Label ID No.	*Infrastructure Identified	Description
1	1. CB 2. 450mm CI lead	Remove CB and CB lead. CB lead under 16 th Avenue is shown as daylighting to greenspace in Bowness Road to EB 16 th Avenue onramp in the City DAS and GIS database. However, could not confirm on google maps review. Should be confirmed in the field with survey.
2	3. 600mm CMP/CULV748 4. CB in median	16 th avenue roadway profile is changing; Grading and backslopes may be adjusted. The culvert may need to be extended or realigned. The CB may need to be removed and replaced.
3	1. 600mm CON storm sewer main 2. Upstream & Downstream storm manholes (IDs 400013498 & 400012575)	Bowness road is not slated for major profile/grade changes. But, the identified storm main and storm manholes may be affected by the proposed EB 16 Avenue – NB/SB Shaganappi offramp, new bridge crossing Bowness road and subsequent regrading around the proposed new road. Realignment and modifications to the main and upstream and downstream connections may be required.
4	1. 1200mm x 1650mm CON Duct 2. Upstream & Downstream storm manholes (IDs 400013301 & 400013305)	Shaganappi trail realignment and reprofiling/grading will potentially decrease the cover to non-standard depths and manhole rim elevations of the identified storm duct and manholes may need adjustment. Regrading in the greenspace where the manholes are identified may also impact the manhole location and rim elevation. Realignment of the storm duct and manholes may be required to accommodate proposed site conditions and stormwater management.
5	1. 1350 CON storm sewer mains 2. Storm manholes (IDs 400013312 & 400013313) 3. Connected CBs and existing storm depression	Shaganappi trail realignment and reprofiling/grading will potentially decrease the cover on identified storm sewer mains and storm manholes. Modification to rim elevations may be required. Identified CBs and storm depression will be removed with regrading and profiling of the roadway. CBs will be moved/added to the new Shaganappi road profile low lying area in the proposed condition. Storm depression storage will be accommodated in proposed storm facility and depression locations in the proposed storm plan.
6	CBs in Shaganappi Trail traplow	CBs in existing trap low and greenspace depressions adjacent to the roadway on Shaganappi Trail will be removed. The realignment of Shaganappi trail will adjust the location and profile of the existing traplow. The existing roadway will be closed in this identified region in the proposed condition and will be reestablished as greenspace. Some regrading will be required to accommodate the WB 16 th Avenue – NB/SB Shaganappi Trail offramp and proposed drainage plan. If possible, existing storm mains and manholes in this region will remain. As required, modification to storm manhole rim elevations should be addressed.
7	CB in Shaganappi Trail	Remove flow-by CB. It is impacted by the realignment of Shaganappi trail, proposed Shaganappi – EB 16 th Avenue onramp, and the proposed condition stormwater plan.
8	CBs on 16 th Avenue	Remove and replaced identified CBs to align with the new roadway profile in the same location. The CB leads should not be reconnected to existing storm manhole, but rerouted in alignment with the proposed storm drainage plan. This will be identified in a subsequent section of the report.
9	1. 675mm CON drainage collection pipe 2. Downstream storm manhole (ID 400016599)	Remove or decommission drainage collection pipe and storm manhole. Impacted by 16 th Avenue reprofiling/regrading and proposed onramp from Shaganappi to EB 16 th Avenue.
10	750mm CON/CULV749	Remove culvert. The culvert is shown as connecting the greenspaces north and south of 16 th Avenue between the Shaganappi and Bowness trail bridge crossings in the City DAS and GIS database. However, could not confirm the location of the culvert on google maps during the desktop review. Should be confirmed in the field with survey.
11	450mm CON inlet pipe	Remove due to road closure, potential regrading and reestablishing of greenspace.
12	1. 2-interconnected CBs & lead pipe 2. Daylighting outlet pipe to greenspace	Remove due to road closure, potential regrading and reestablishing of greenspace.
13	Drainage inlet (grate/pipe)	Remove and replace grate/inlet with standard manhole rim or cover. Regrading and greenspace reestablishment in the proposed condition in this area is required for the proposed drainage strategy.

Note: *Site survey is required to confirm the extent of impacts to the listed infrastructure and to confirm the location of all infrastructure potentially not identified or misidentified in the City DAS and GIS database provided at the time of this study. Block profiles were limited in this site area and as-built drawings were not available at the time of this study for review. All linear infrastructure and catch basins need to be surveyed in the project boundary; focusing in regions where changes to grades and the proposed roadway will potentially impact existing infrastructure.



\\C:\002-104\shared_projects\113677973\07_cad\work_files\bms\New folder\113677973_pre_civil\ex_sfrm_plan_figure-7-submission.dwg
4:10 PM 9 May 2017 - Stantec, Brittany

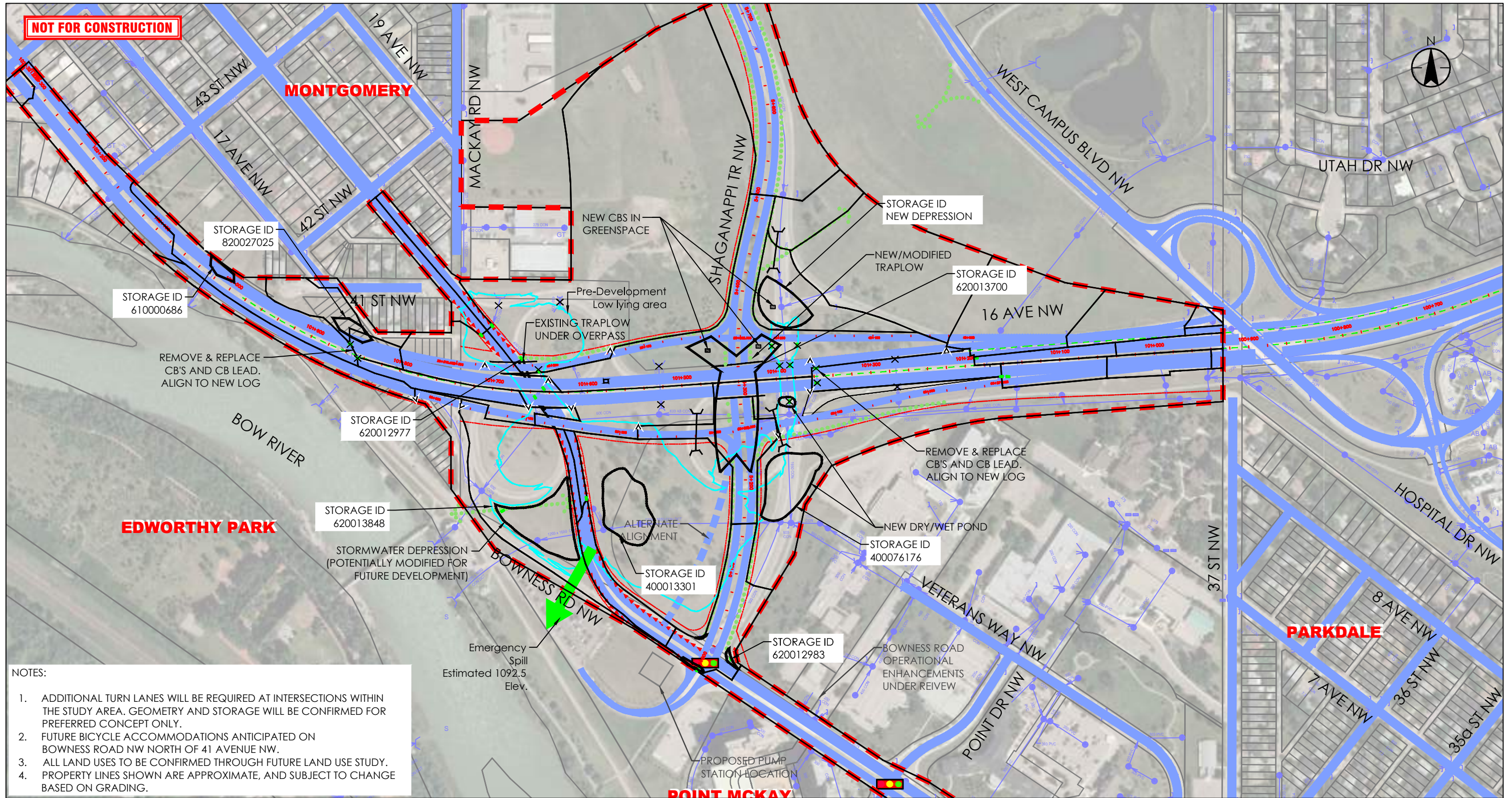

- NOTES:
1. ADDITIONAL TURN LANES WILL BE REQUIRED AT INTERSECTIONS WITHIN THE STUDY AREA. GEOMETRY AND STORAGE WILL BE CONFIRMED FOR PREFERRED CONCEPT ONLY.
 2. FUTURE BICYCLE ACCOMMODATIONS ANTICIPATED ON BOWNESS ROAD NW NORTH OF 41 AVENUE NW.
 3. ALL LAND USES TO BE CONFIRMED THROUGH FUTURE LAND USE STUDY.
 4. PROPERTY LINES SHOWN ARE APPROXIMATE, AND SUBJECT TO CHANGE BASED ON GRADING.

SCALE: 1:4000 0 10 25 50 75 100m

June 2018
113677973



200 - 325 25th Street SE
Calgary, AB T2A 7H8
www.stantec.com

Legend

- | | | | | |
|------------------------|------------------------|---------------------|--|--------------------------|
| ROADWAYS | EXISTING CULVERT | STUDY AREA BOUNDARY | PROPOSED CULVERT | SWMF OR DEPRESSION |
| PROPOSED PATHWAY | EXISTING PROPERTY LINE | STORM REMOVALS | CURB CUTS | MANHOLE |
| PROPOSED PROPERTY LINE | EXISTING PROPERTY LINE | PROPOSED BRIDGE | EXISTING LOW AREA SPILL ELEV. ESTIMATED 1092.5 | PROPOSED CATCHMENT AREAS |
| | | | EMERGENCY OVERLAND SPILL | |

Client/Project
THE CITY OF CALGARY
SOUTH SHAGANAPPI
CORRIDOR STUDY
Figure No.
6.11
Title
**SANITARY UTILITY
ASSESSMENT**

Recommended Concept

6.8 OPINION OF PROBABLE COST

A preliminary order of magnitude opinion of probable cost was prepared for the recommended concept. This is summarized in **Table 6-2**, with a detailed breakdown included in **Appendix L**.

Table 6-2 - Long Term Concept Opinion of Probable Cost Summary

Category	Cost*
Roadways	\$11,650,000
Earthworks	\$3,350,000
Bridges	\$29,220,000
Retaining Walls	\$1,850,000
Removals, Stormwater, Utilities, and Landscaping	\$14,180,000
Sub-Total	\$60,250,000
Contingency (30%)	\$18,070,000
Engineering / Testing (12%)	\$9,400,000
City Administration and Traffic Control (21%)	\$16,460,000
Total	\$104,180,000

*Rounded to the nearest \$10,000

7.0 IMPLEMENTATION

Implementation of the Recommended Short Term Investments and Long Term Concept are subject to The City's infrastructure investment prioritization process, and should be coordinated and prioritized amongst the different transportation needs within the transportation network of The City. This section provides a description of the funding process, anticipated implementation timeline, and recommendations for future study within and adjacent to the study area.

7.1 FUNDING PROCESS

Should the recommended Short Term Investments and Long Term Plan be approved by Council, both will become candidates for funding as part of The City's Transportation Infrastructure Prioritization Plan. This plan occurs on a bi-annual basis, and prioritizes available infrastructure funding amongst different approved projects within The City.

It is recommended that the Short Term Investments be considered independently from the Long Term Concept, such that important existing issues within the study area can be addressed prior to the complete implementation of the Long Term Concept.

7.2 IMPLEMENTATION TIMELINE

Certainty for the implementation timeline of the Short Term Investments and Long Term Concept cannot be provided with clarity, given the fluctuating nature of The City's budget and infrastructure priorities. However, the following timeline considerations are highlighted for reference:

- The Long Term Plan should not be implemented before the Medium Term Crowchild Trail Study improvements are completed.
- The existing 16 Avenue bridge structures at Shaganappi Trail and Bowness Road are anticipated to provide a useful lifespan through to 2045.

These considerations highlight that implementation of the Long Term Concept would not be expected until after 2045.

Implementation of the Short Term Investments can be undertaken at any point, and will provide an immediate high value to enhance road safety, pedestrian and bicycle connectivity, and motor vehicle traffic operations.

7.3 RECOMMENDATION FOR FUTURE STUDY

In addition to the preliminary engineering design required as the next step for both the Short Term Investments and the Long Term Concept, the following studies are recommended as an output of this project:

1. 16 Avenue Corridor Study to recommend long term plans for 16 Avenue from west limits of the City to Banff Trail.
2. Planning study to develop repurposing vision for the remnant land that is no longer required for transportation infrastructure.
3. Transportation corridor study for Bowness Road/3 Avenue/Parkdale Boulevard between Shaganappi Trail and Crowchild Trail to develop long term plans that align with the approved long term plans for Crowchild Trail and Shaganappi Trail.
4. Citywide HOV Network Study to identify HOV routes and connections.